

Product catalogue

MONORAIL and AMS

Profiled linear guideways

and integrated measuring systems

Table of contents

1. Product Overview

1.1 Overview of all MONORAIL products	Page 3
1.2 Features of the MONORAIL system	Page 5

2. Technical Data

2.1 Guiding	Page 10
2.2 Guiding and driving	Page 19
2.3 Guiding and measuring	Page 20
2.4 Ordering information	Page 32
2.5 Precautionary measures	Page 34

3. Roller-MONORAIL MR



3.0 Introduction	Page 35
3.1 Overview of types, sizes and options	Page 38
3.2 Technical data	Page 40
3.3 Accessories	Page 52
3.4 Order code	Page 59

4. Ball-MONORAIL BM



4.0 Introduction	Page 61
4.1 Overview of types, sizes and options	Page 64
4.2 Technical data	Page 66
4.3 Accessories	Page 78
4.4 Order code	Page 84

5. Stainless steel Ball-MONORAIL BM WR / BM SR



5.0 Introduction	Page 85
5.1 Overview of types, sizes and options	Page 88
5.2 Technical data	Page 90
5.3 Accessories	Page 98
5.4 Order code	Page 99

6. MONORAIL BZ toothed rack systems



6.0 Introduction	Page 101
6.1 Overview of types, sizes and options	Page 104
6.2 Technical data	Page 106
6.3 Accessories	Page 110
6.4 Order code	Page 114

7. MONORAIL AMS 3B distance measuring system for MR



7.0 Introduction	Page 115
7.1 Overview of types, sizes and options	Page 118
7.2 Technical data	Page 120
7.3 Accessories	Page 130
7.4 Order code	Page 132

8. MONORAIL AMS 4B distance measuring system for BM



8.0 Introduction	Page 133
8.1 Overview of types, sizes and options	Page 136
8.2 Technical data	Page 138
8.3 Accessories	Page 150
8.4 Order code	Page 151

9. MONORAIL AMSABS 3B absolute distance measuring system for MR



9.0 Introduction	Page 153
9.1 Overview of types, sizes and options	Page 156
9.2 Technical data	Page 158
9.3 Accessories	Page 168
9.4 Order code	Page 169

10. MONORAIL AMSABS 4B absolute distance measuring system for BM



10.0 Introduction	Page 171
10.1 Overview of types, sizes and options	Page 174
10.2 Technical data	Page 176
10.3 Accessories	Page 188
10.4 Order code	Page 189

11. MONORAIL AMSA 3L integrated, modular distance measuring system for long axes



11.0 Introduction	Page 191
11.1 Overview of types, sizes and options	Page 194
11.2 Technical data	Page 196
11.3 Accessories	Page 206
11.4 Order code	Page 208

1.1 Overview of all MONORAIL products



MR

High rigidity, great dynamic and static load carrying capacity, outstanding running smoothness and the total enclosure of the carriage are the main features of the MONORAIL guideway. These properties result in higher machining rates while enhancing geometrical accuracy and surface quality of the machined workpieces. Our highly rigid MONORAIL provides improved vibration behavior, smaller vibration amplitudes and thus extends tool life.

SCHNEEBERGER has systematically applied its many years of experience in the design, production and use of roller-type anti-friction guideways in the development of the MONORAIL. Consequently the MONORAIL MR is a cost-effective anti-friction guideway which meets the challenge presented by modern machine design.



BM

SCHNEEBERGER's MONORAIL BM ball guideway features excellent dynamic properties and many commercial benefits. Designed with a small number of cleverly arranged components, it provides for excellent running properties due to the small number of transitions in the ball tracks, which lead to very quiet running, low pulsation and low friction as well as high travel speeds. The use of a trapezoidal rail section results in an extremely rigid guideway coupled with a substantial reduction in servicing time as additional wipers can be changed without dismantling the carriage. Complete sealing of the carriage guarantees maximum reliability coupled with a long service life. This robust and economical guideway rounds off SCHNEEBERGER's range of products for industrial applications with high demands on speed, reliability and constant running properties.

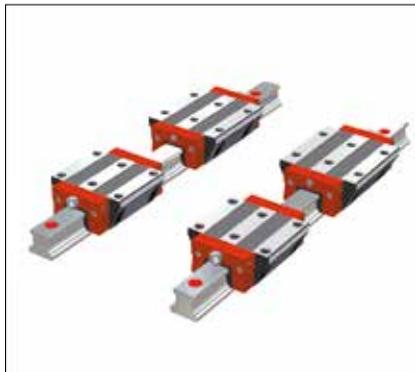

BM WR / BM SR

SCHNEEBERGER's MONORAIL BM WR / BM SR systems are linear bearings made from corrosion-resistant steel and based on the MONORAIL BM ball profile guideway. They have been specially developed to meet requirements that are beyond the limits of what conventional coatings on linear bearings can cope with. This is often the case, for example, in processes where corrosion has a negative impact on conveying the products.

The MONORAIL BM WR/ BM SR also features the proven characteristics of the MONORAIL BM, such as excellent running properties, high travelling speed and a long service life.

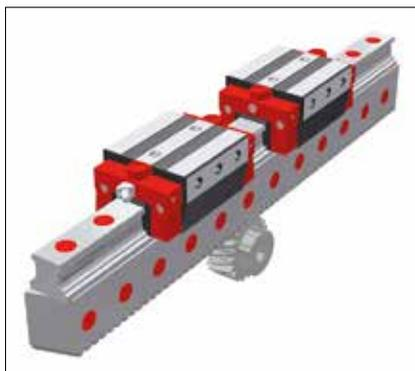

BZ

SCHNEEBERGER's MONORAIL BZ systems are high-precision linear guide systems with integral rack drive, based on the company's proven MONORAIL BM profile guideways with balls. The benefits resulting from the integration of a profile guideway and an extremely precise rack drive mainly come into their own in the handling and automation industries, in laser and water-jet cutting tools as well as in woodworking machines.

Outlay on the production of machine beds, the installation and alignment of the guideway and gearing are substantially reduced. Single piece rail systems are available up to a length of 6 metres.

The design of the MONORAIL BZ provides for superb operating characteristics, high load-bearing capacity and rigidity together with a long service life thanks to the use of the tried-and-tested MONORAIL BM profile guideway and to the high transmittable forces, smooth running and optimum positioning accuracy offered by ground, hardened and precise helical gearing of superlative quality.



AMS 3B

The MONORAIL AMS 3B is an integrated magneto-resistive measuring system for absolute distance measurement based on the MONORAIL MR roller profile guideway. This results in the provision of a compact axis with linear measurement and guidance specially for machine tool applications. No additional assembly or adjustment of the measuring system is required, which is reflected by cost savings in machine design, manufacture and servicing. The accuracy and process reliability of the machine are also improved. The sturdy housing for the read-head has a complete wiper system consisting of longitudinal and cross wipers, which provide optimum protection for the measuring system.

AMS 3B is available in both analog and digital versions. The AMSA 3B analog version has a voltage interface of 1 Vpp for connection to all standard control systems, and forms the basis for the AMSD 3B digital version. The profile rails are thus identical and are compatible with both versions.

The AMSD 3B version has an incremental, digital interface and a range of reading head options that permit different resolutions and allow the system to be adapted to control systems with different input frequencies.

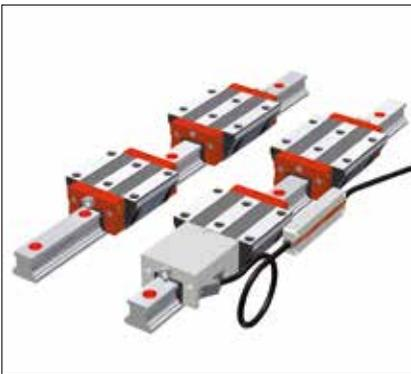

AMS 4B

The MONORAIL AMS 4B is an integrated magneto-resistive measuring system for distance measurement based on the MONORAIL BM ball profile guideway. In measuring terms, the AMS 4B is the same as the AMS 3B; it offers the same performance in terms of assembly, cost savings, accuracy and process reliability.

AMS 4B products are preferred for use in applications that make major demands on travelling speed and require good resistance to acceleration and vibration.

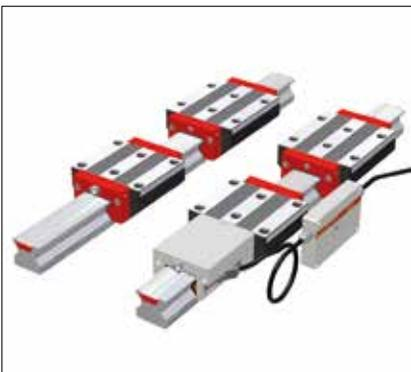

AMSABS

The MONORAIL AMSABS is an integrated magneto-resistive measuring system for distance measurement with an absolute interface. The AMSABS 3B is based on the MONORAIL MR roller profile guideway, while the AMSABS 4B is based on the MONORAIL BM ball profile guideway.

New features have been added to the proven benefits of the AMS products. These simplify the use of distance measuring systems in industrial environments. Because of the absolute nature of the measuring system for distance measurement, there is no longer any need for a reference run after switching on. This saves time, and thus saves costs. In addition, redundancy of information processing increases operational reliability.

The AMSABS features an absolute interface for connection with SSI controllers, SSI+SinCos controllers and all FANUC controllers.

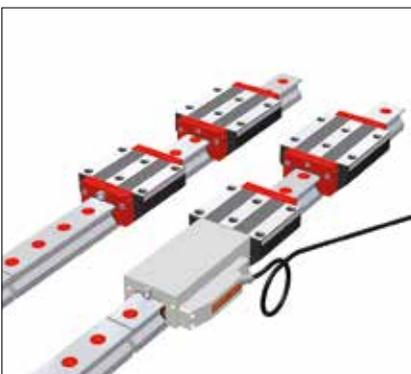

AMSA 3L

The MONORAIL AMSA 3L is an integrated magneto-resistive measuring system for distance measurement based on the MONORAIL MR roller profile guideway with an analog voltage interface. It is SCHNEEBERGER's newest product, and is designed for use with very long axes. The AMSA 3L is made possible by the very precise construction of the measuring rails, in both mechanical and measuring terms. The special design of the rail joints, combined with the AMSA 3L reading head, means that it is possible to travel across the joints and to make the measuring axes as long as you wish. Other features of the AMSA 3L include fully interchangeable individual rails, carriages and reading heads, and reading heads with integrated electronics. A special production process also ensures that AMSA 3L components are widely available around the world. The AMSA 3L has an analog voltage interface of 1 Vpp for connection to all standard control systems.

1.2 Features of the MONORAIL system

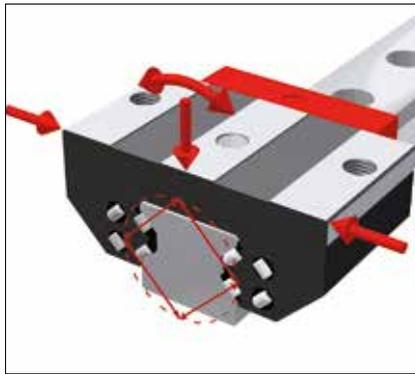

O-geometry

Large internal spacings of the load carrying surfaces are implemented with what is called an O-arrangement of the guideway. In conjunction with roller tracks that are offset by 90°, this achieves a uniform and high absorption of forces from all directions and provides high moment rigidity.

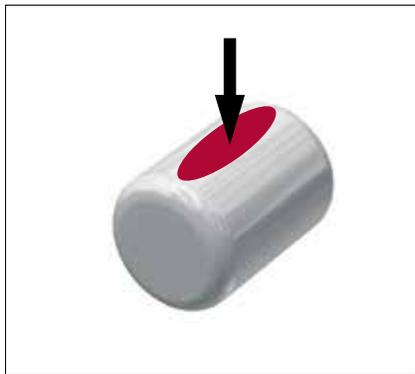

Roller with a convex 'barrel' profile

Linear guideways have a significant influence on the overall rigidity of a machine tool. With roller MONORAIL MR, the demonstrably high degree of rigidity is achieved by using rollers, with a convex profile, as rolling elements and the optimized cross-sections of the carriage and the rail.

Compared with a ball guide, a roller guide has a flat and much larger contact area, which results in a far greater load carrying capacity.

The barrel shape enables the contact surface to adjust to the particular load and provides a smooth transition from the load zone to the unloaded recirculation area.

This results in a significant reduction in wear since it avoids edge loading coupled with minimum roller friction.

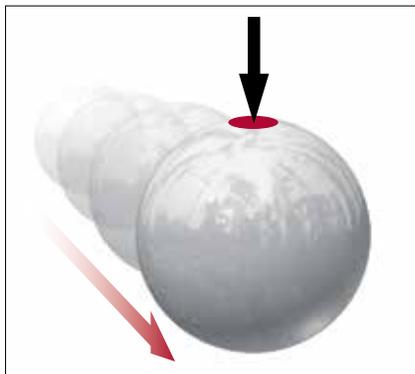

Ball with 2-point contact

The MONORAIL BM is a modern, 4-row ball guide with O-geometry. Even when pre-loaded and under load, a ball that is in the load zone only contacts the track contour of the rail and the carriage at two diametrically opposed points. Compared to a guide with 4-point contact, the precision fit of the tracks to the ball provides significantly greater load carrying capacity. Friction is minimised as the balls roll more or less without any differential slip, which results in smooth, even running.

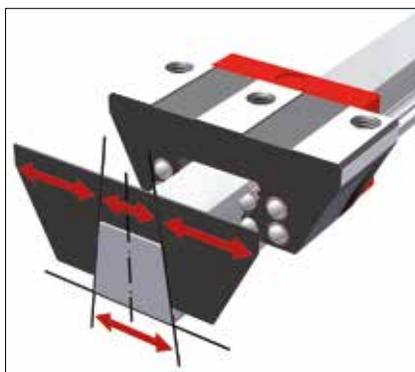

Trapezoidal rail profile

The trapezoidal rail profile meant it was possible to optimize the carriage cross sections and the connection of the base surface of the rail to the sub-structure to achieve the highest possible rigidity. This rail profile enables easy servicing since additional wipers can be replaced directly on the rail without any complicated removal of the carriage.

1.2 Features of the MONORAIL system

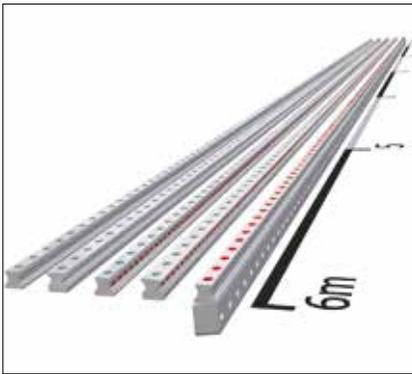

In one piece up to 6 metres long

SCHNEEBERGER offers guideways for all its products in single piece lengths of up to six metres. As a result, fewer butt joints between rails are required on long guideways. This not only simplifies assembly work, but also offers improved accuracy and extends the service life of the system.

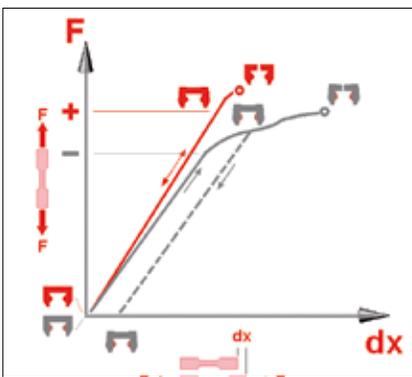

Through-hardened carriages

The steel body of the carriage is a critical element if a machine is to have a long service life with a constant level of precision. In order to satisfy these high demands, even under extreme loads and without any plastic deformation of the carriage throughout its entire period of use, SCHNEEBERGER uses high-grade bearing steels in which not just the running surfaces, but the complete carriage body are hardened. Even when subjected to loads exceeding their recommended levels, MONORAIL carriages maintain their specification as no plastic deformation can occur.



6 attachment holes per carriage

When a carriage is subjected to tensile forces, the rigidity achieved is largely dependent on the way that it is connected to its surrounding structure. In order to achieve the maximum degree of rigidity, all SCHNEEBERGER carriages have six threaded fixing holes in the top of the carriage.

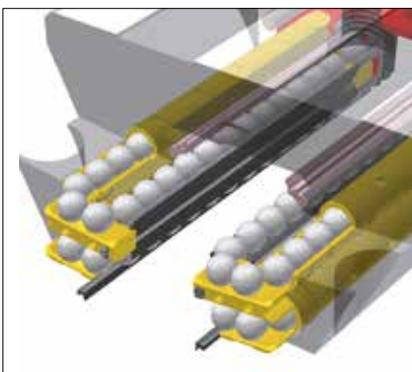

Unique running characteristics

Particular attention was focused on the run-in area of the rollers from the unloaded to the loaded zone. This area was geometrically balanced to provide very smooth operation, i.e. minimum travel pulsation, pitch movement and noise for both low and high speed motion.

1.2 Features of the MONORAIL system

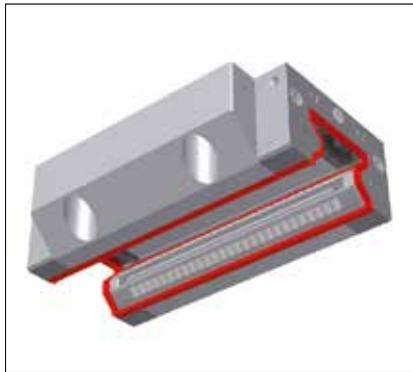

Complete sealing

MONORAIL carriages are equipped as standard with twin-lipped cross wipers on the ends and top and bottom longitudinal wipers. Together with additional sealing of the gaps between the front plate and the steel body, these provide an exceptionally efficient sealing system. The ingress of dirt is therefore effectively prevented and lubrication losses are reduced to a minimum, which results in a significant increase in service life. Correct function of the wipers is improved even further by the smooth, ground surface of all sides of the rail. SCHNEEBERGER also offers various solutions to close the rail fixing holes perfectly flush.

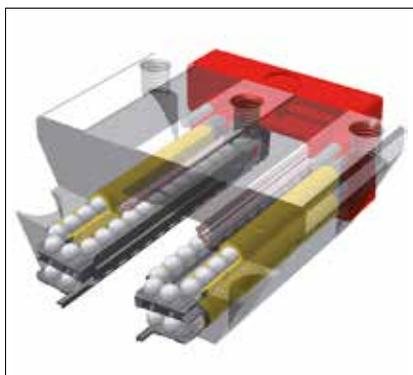

Rolling element recirculation parts made of synthetic material

The return passage of the rolling elements has a substantial influence on the running properties of the carriage. For this reason, all SCHNEEBERGER products are fitted with synthetic recirculation parts. Apart from the reduction in noise, the synthetic components have been designed to form an additional reservoir of lubricant. The additional lubricant can substantially extend the service life of the carriage.



Versatile lubrication connection

Carriages have a range of lubrication connections (on both sides on the front face, at the sides and on top) that can be prepared for connection to a lubrication supply in line with customers' specifications. This allows the connection of the lubrication supply to be connected in the best way to suit the type of lubrication and the specific installation involved. Where oil lubrication for special installation positions is required, both sides of the carriage can also be independently supplied with lubricant.

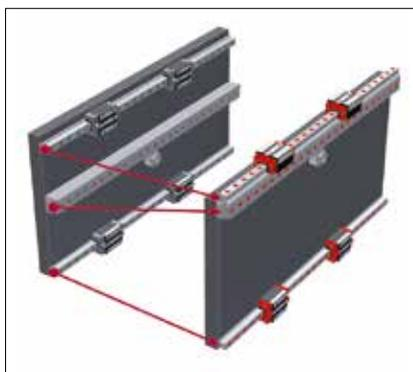

Integral racks

Rack systems offer a high-grade gear rack that is integrated into the guiderail. Single piece rail lengths of 6 metres and the possibility to butt joint rails means very long traverse lengths can be achieved with a high degree of accuracy. Integral construction reduces the amount of manufacturing, assembly and logistics compared with a system with a separate rack, which results in substantial cost savings.

It is now possible to construct a machine axis, that used to require three precision support surfaces with only two. It is no longer necessary to do any time consuming alignment work between the guide system and the rack.

1.2 Features of the MONORAIL system



Integrated linear scales

Combining a high-precision linear encoder with a MONORAIL guide rail results in an integrated measuring system that is simple to install without the need for any separate assembly or adjustment work. This provides cost-savings in the design, manufacture and maintenance of equipment. With its integrated systems, SCHNEEBERGER supplies solutions that offer a substantial reduction in complexity when constructing machine axes with direct linear scale systems.

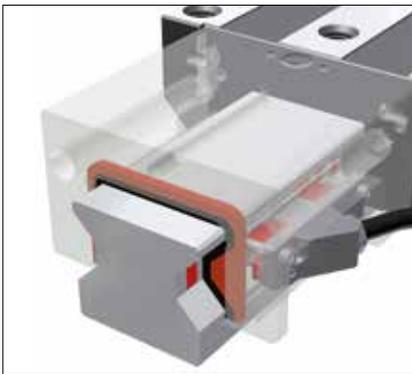

Magneto-resistive measuring principle

The sensor is based on a specially adapted magneto-resistive measuring process. If any relative movement occurs between the sensor and the measuring scale, the change in field strength results in an easily measurable change in electrical resistance. Any interference caused by temperature, superimposed magnetic fields, displacement and ageing is minimised due to the bridge circuit. The sensing head works continuously, which ensures that the function of the sensor is not affected by any particles. The sensing process operates so well that no adjustment work is necessary after service exchange of a measuring head.

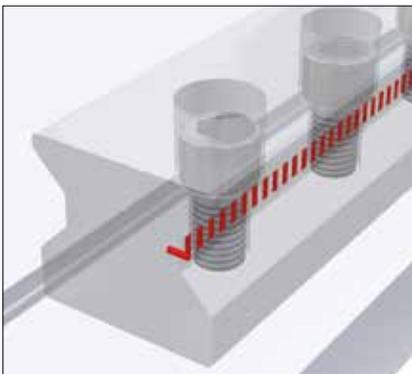

Position measurement close to the process

A good thermal connection between the measuring system and the bed of the machine is provided, firstly, by the extensive connection of the guiderail to the integral measuring scale and, secondly, by the rigid attachment of the guiderail to the bed of the machine. The benefit of this is that changes in the temperature of the bed of the machine are transferred directly to the measuring system. The good thermal interconnection between the measuring standard, the guiderail and thus the bed of the machine means that these machines do not require any reference points or temperature sensors to achieve excellent process stability.

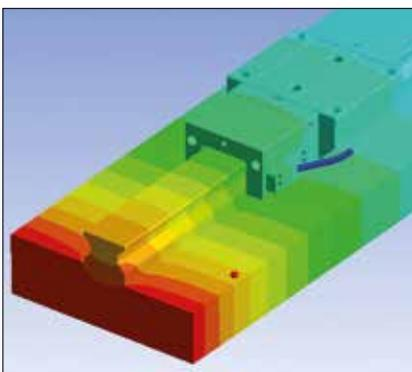

Thermal expansion like steel

The magnetic measuring scale is installed in a groove in the rail section. Use of a specially adapted ferromagnetic material ensures that the longitudinal expansion of the scale, caused by thermal influences, is identical to the expansion of the steel bed of a machine.

The measuring standard is firmly attached at both ends to the guide rail and has exactly the same rate of expansion as the guide rail. No compensation for temperature is therefore required when machining steel parts.

1.2 Features of the MONORAIL system

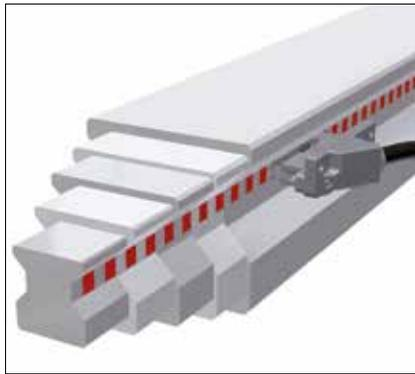

One reading head for all sizes

The measuring scale is positioned identically on all rail sizes, meaning a single reading head can be used for all sizes of the product group concerned. The measuring scale is fixed very robustly in the rail and any effect of wear is taken by the reading head slider. All reading heads can be used on all models of rail supplied. These 3 points mean that only a small service stock of reading heads is needed to support a high volume of installations.

The new generation of reading heads offer increased waterproofness to IP68 and are made of rust-resistant materials. The connections between parts are also resistant to chemical substances. This ensures that SCHNEEBERGER AMS products retain their proven characteristics even in areas where they are constantly exposed to water, aggressive cooling lubricants or other emulsions.

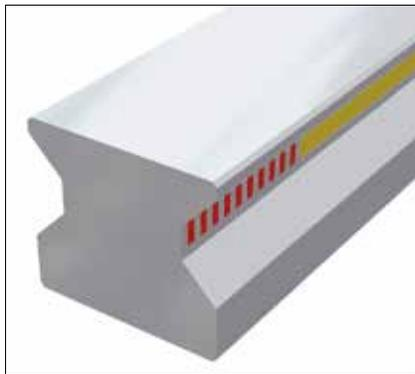

Protected measuring scale

Following production, the integral measuring scale is protected from mechanical damage and magnetic interference by an extremely hard, non-magnetic cover strip. Using a special manufacturing process, the strip is laser welded to the rail which reliably protects the measuring scale from the effects of coolants and wear and tear. Measuring scales are consequently extremely robust and reliable.

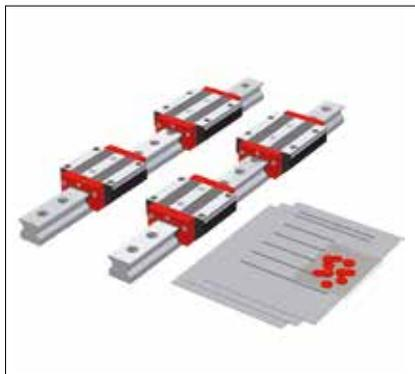

Supply of complete axis sets

If required, SCHNEEBERGER products can be supplied as sets ready for installation. This means that customers receive complete rail and carriage sets built up and checked to their requirements. The protection required is also adapted to suit individual requirements. Assembly by the customer is therefore limited to essential tasks such as aligning the systems to the surrounding structure, connection to the drive elements and lubrication system as well as hooking up the sensor system connection to the control system.

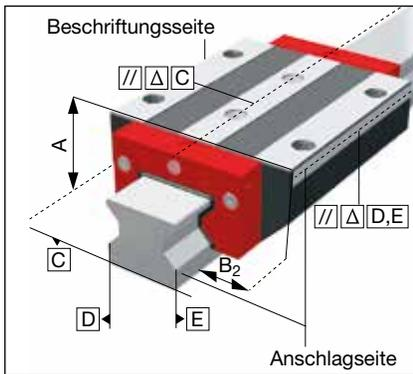

Accuracy classes

The four accuracy classes allow the user to select both the guiderails and the carriages in line with specific application and design requirements. Accuracy classes define the running accuracy of the rails and determine the dimensional tolerances of the carriages.

-  G0 Highly accurate
-  G1 Very accurate
-  G2 Accurate
-  G3 Standard

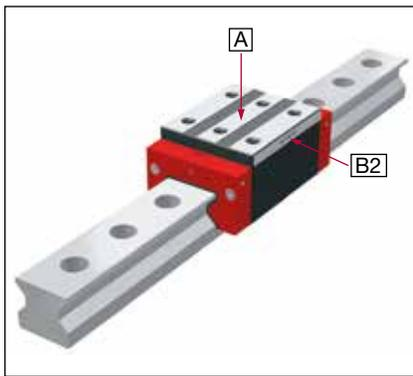

Dimensional tolerances

MONORAIL carriages and rails are manufactured independently of each other, both to very tight tolerances, and are therefore completely interchangeable. This means that any carriage can be used on any rail of the same size without any influence on the preload level because the preload is determined by the rolling elements of the carriage. For the dimensional differences between any carriages on any rail, the values from column one of the following table are applicable.

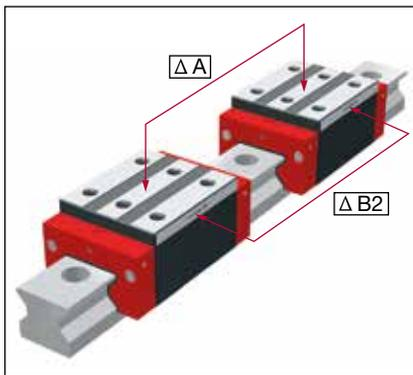

Accuracy classes	Tolerances between carriages and rails	Max. dimensional difference between the carriages of a rail	Max. dimensional difference of the carriages between 2 or more rails, standard
	A/B ₂	ΔA/ΔB ₂	ΔA Standard
G0	± 5 μm	3 μm	10 μm
G1	± 10 μm	5 μm	20 μm
G2	± 20 μm	7 μm	40 μm
G3	± 30 μm	25 μm	60 μm
	Measured at the middle of the carriage and in any rail position	Measured at the middle of the carriage and at the same rail position	Measured at the middle of the carriage and at the same rail position

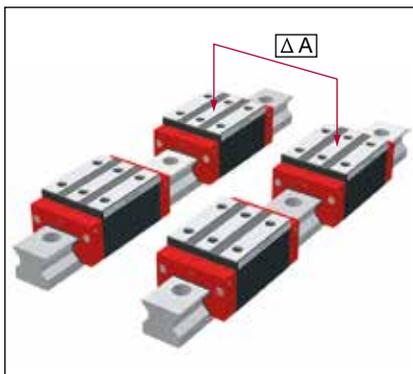

Matched carriages

All the carriages in a set are fitted one behind another on a production norm, and their top and side joint surfaces are ground smooth. Then the main dimensions A and B2 are measured on a test rail, and the carriages would then be paired up. There are two quality levels of carriage matching.

Matching carriages	Maximum dimensional differences between carriages in a pair
Version	$\Delta A/\Delta B2$
SLWGP0	3 μm
SLWGP1	5 μm

Matched rails

With "matched rails", we search the data to find suitable rails with similar characteristics. The criterion used for the selection process is the maximum difference in the run-off over the rail length, the so-called pairing tolerance. The range of all run-off reports for matched rails lies within this tolerance. Matched rails are available in four quality levels.

Matching rails	Mating tolerance
Version	
SLSGP0	5 μm
SLSGP1	10 μm
SLSGP2	15 μm
SLSGP3	20 μm

Running accuracy

The run-out accuracy of the carriages can be either linear or a wave-shaped within the tolerance limits. The maximum permissible deviation is defined by the accuracy class of a rail. The actual tolerance is determined from the above diagram as a function of rail length and accuracy class. Example: L 3 = 2000 mm with G2 accuracy gives a tolerance of 0.015 mm.

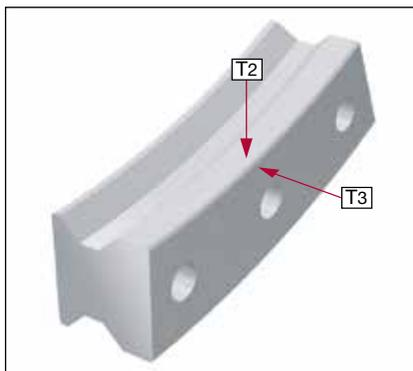
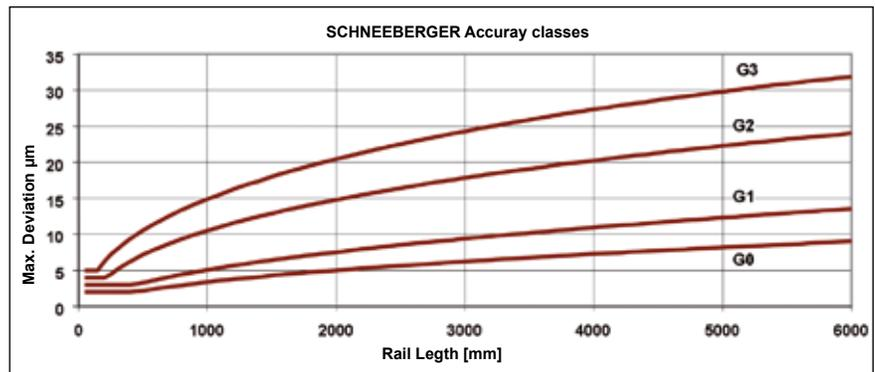

Straightness

To install profile guideway sections efficiently, it is essential to know the longitudinal degree of straightness and the curvature of a rail. As the rail section guideways are flexible components, they can deform longitudinally due to their own weight. Deformation can also be caused by the manufacturing process. In order to meet customers' installation requirements, rail straightness is optimised during manufacture. In addition to standard tolerances for rail deformation, SCHNEEBERGER offers special tolerances and / or inspection reports to a specific customer requirement.



Preload classes

The roller guideways are preloaded to enable them to work free of play under different load conditions. Basically, while preloading increases the rigidity of the guideway, it also affects operational life and increases the push force. SCHNEEBERGER guideways are available in various preload classes to address specific application requirements. The preload classes are dependent on the dynamic loading capacity C.

-  V0 Very low
-  V1 Low
-  V2 Medium
-  V3 High

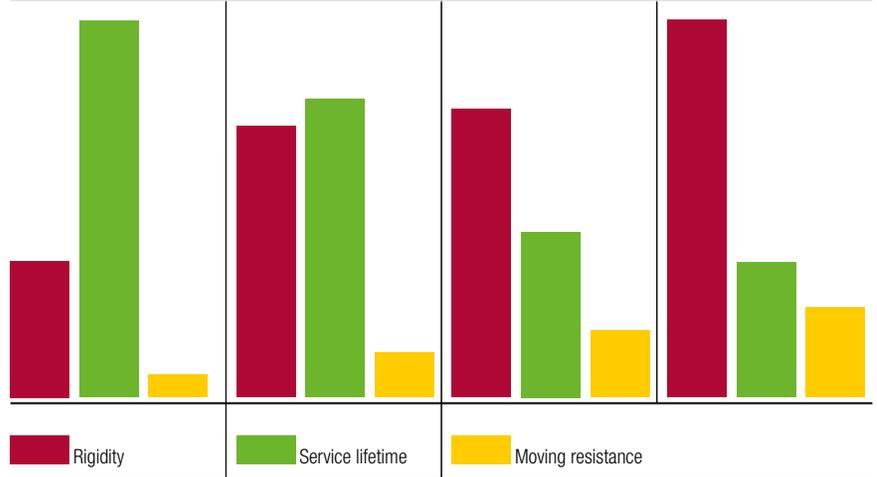
Preload classes			
V0	V1	V2	V3
Preload			
0 - 0.02 x C ₁₀₀	0.03 x C ₁₀₀	0.08 x C ₁₀₀	0.13 x C ₁₀₀
Operating conditions			
Very low-friction guideways for uniform loads, minimum vibrations	Low-friction guideways for uniform loads, slight vibrations	For high rigidity, medium, changing loads and vibrations	For highest rigidity, high impact / shock loads and vibrations, strongly changing, high loads and torques
Characteristics			
			
Rigidity		Service lifetime	Moving resistance

Reference sides

Dependent on installation conditions of the products, the reference sides (attachment side) of the carriages and the section rails must be stated when placing an order.

A drawing of the products is the basis for this. R1 means below or right, R2 means top or left.

-  R1 Reference bottom
-  R2 Reference top

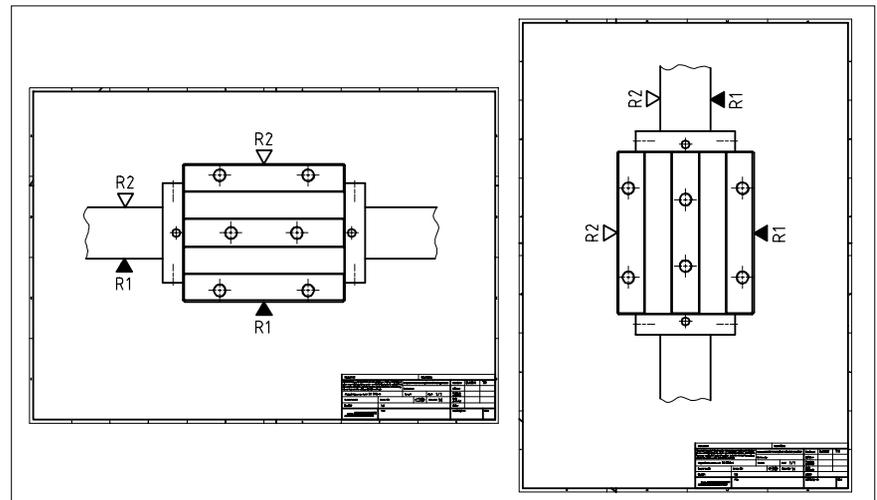

Lubrication connections

Front plates and carriage bodies have a wide range of options for lubrication connection. It is therefore possible to optimise the lubrication supply to the carriage to meet structural design. Either a lubricating nipple or a central lubrication system can be screwed into each connection. As standard, all four tracks are lubricated through one connection.

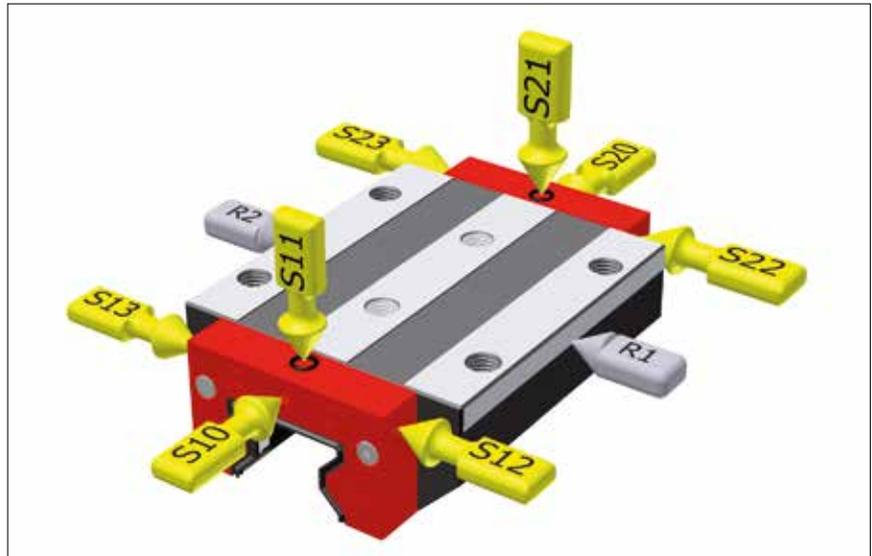

Separate carriage lube connections for specific mounting positions

As a special feature for certain installation positions, SCHNEEBERGER systems provide for the independant lubrication of both sides of a carriage. This enhances the lubrication of the guideway and thus the service life of the machine.

Position of lubrication connection is defined with line of sight to the location side R1 in accordance with the picture.

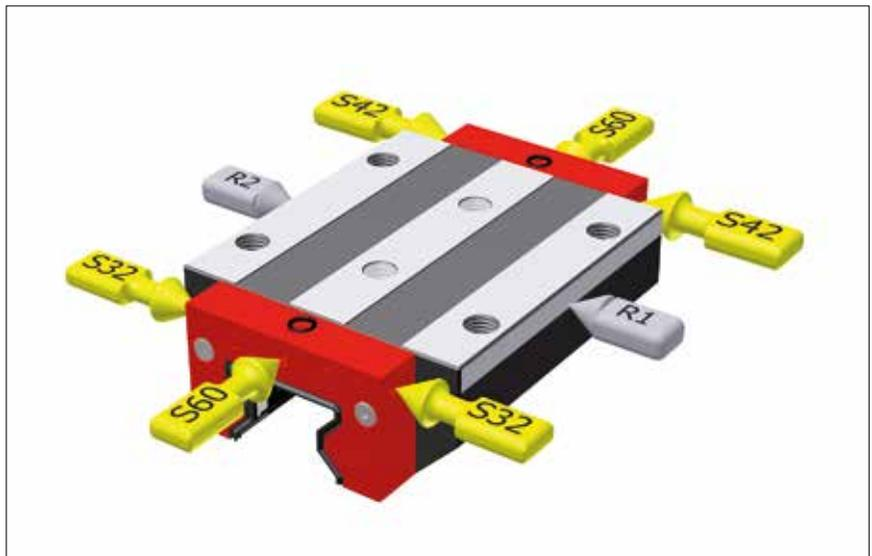

-  Left center
-  Right center
-  Top left
-  Top right
-  Lower left side
-  Lower right side
-  Upper left side
-  Upper right side
-  Left side
-  Right side
-  Center (only for MR 25)

Lubrication as delivered condition

The carriages fitted to guideways can be supplied with a wide variety of lubricants according to the demands of the application, storage life and the final type of lubrication. For applications that provide continuous lubrication during installation and operating phases, oiling with oil (LN) or a light application of grease (LG) are enough.

A full application of grease (LV) is recommended for applications with manual lubrication.



Oil protect



Grease protect



Full greasing

Friction

Push force is an important value within the system properties of a guideway. In the case of profile guideways, this is largely dependent on the friction of the sealing system. There is also friction from rolling contact and sliding friction when changing direction and returning.

Application specific frictional forces, such as the type of lubrication, the amount of external load as well as speed, are also present.

To minimize friction, SCHNEEBERGER profile guideways are manufactured with special plastics. To adjust friction from seals, sealing systems are available which have been adjusted to the application.

Coating

For applications where special corrosion protection is necessary, such as in cleanroom applications or due to high levels of humidity or when increased wear resistance of the surface is required, MONORAIL carriages and rails are available in hard-chrome plated versions.

The main advantages of applying this electroplated coating are:

- Excellent corrosion protection
- Very good wear resistance and surface load bearing capacity
- Smooth and good emergency running characteristics due to its micropore structure
- Exceptional adhesion
- Consistent depth of coating

Please note that holes, threads and operating elements are not chrome-plated.



None



Hard chromium

Grease nipples

Grease nipple SN 6

Hydraulic-type grease nipple straight

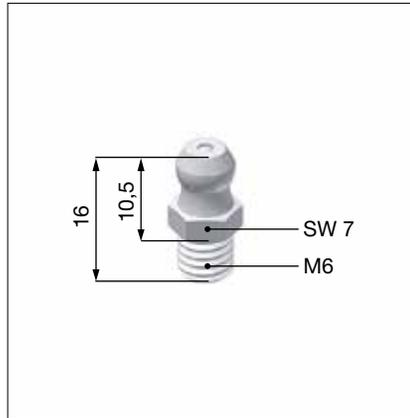

Grease nipple SN 3-T

Flush type grease nipple M3

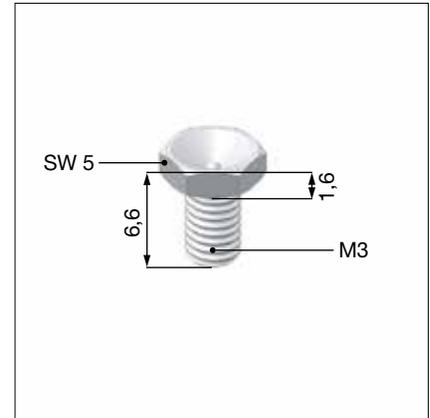

Grease nipple SN 6-45

Hydraulic-type grease nipple 45°

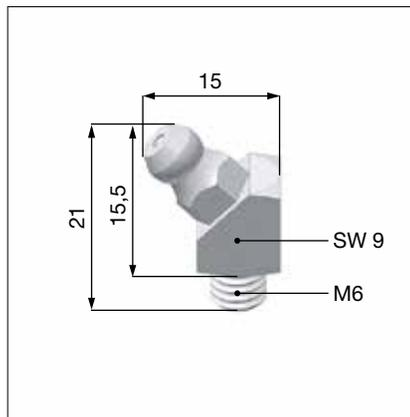

Grease nipple SN 6-T

Flush type grease nipple M6



Grease nipple SN 6-90

Hydraulic-type grease nipple 90°

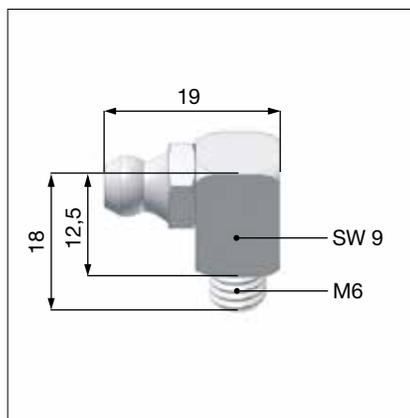

Grease gun SFP-T3

Grease gun for SN3-T and SN6-T

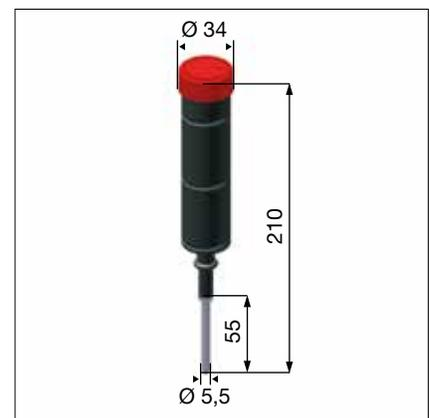

Lubrication adapters

Lubrication adapter SA 3-D3
Screw-in connection M3

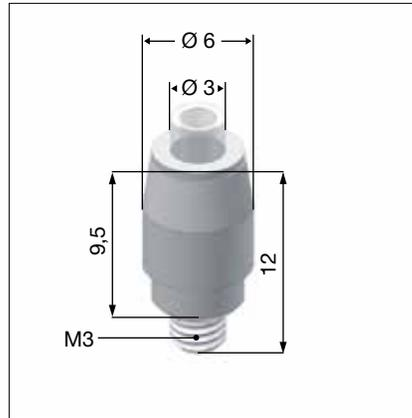

Lubrication adapter SA 6-RD-M8
Lubrication adapter M8 round-head

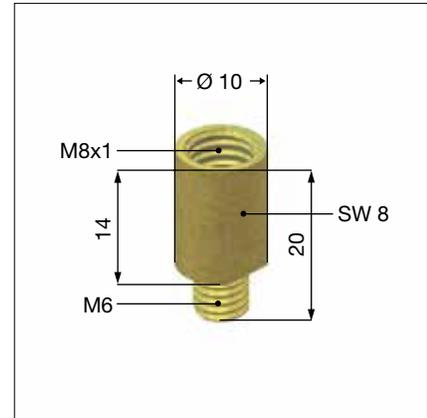

Lubrication adapter SA 6-6KT-M8
Lubrication adapter M8 hexagon head

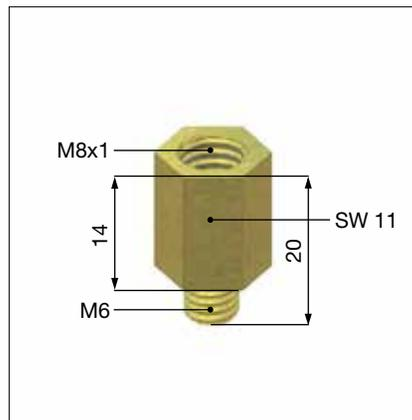

Swivel screw connection SV 6-D4
Swivel screw connection for hose connection 4mm

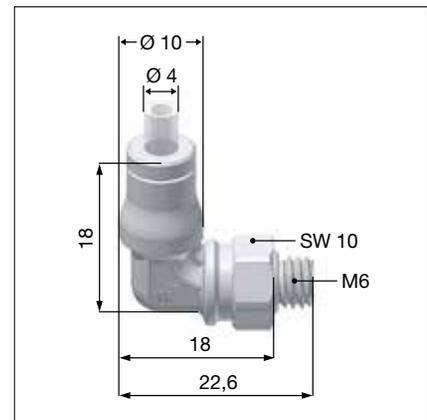

Lubrication adapter SA 6-6KT-G1/8
Lubrication adapter G1/8 hexagon head

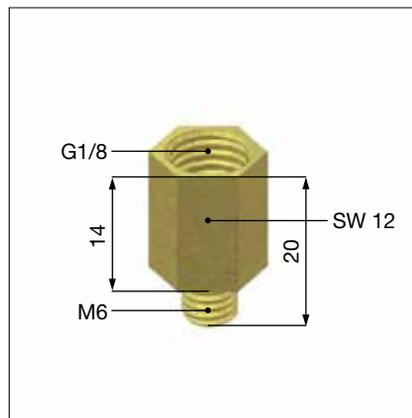

Swivel screw connection SV 6-M6
Swivel screw connection M 6
(aluminum sealing)

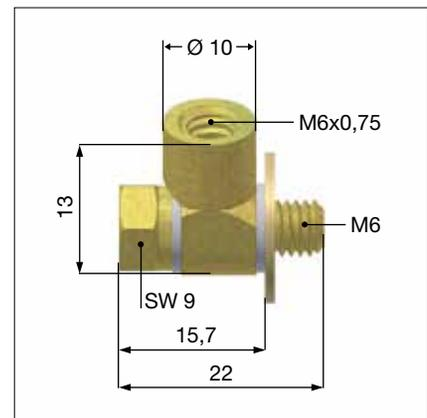

Screw connections

Swivel screw connection SV 6-M8

Swivel screw connection M 8
(aluminum sealing)

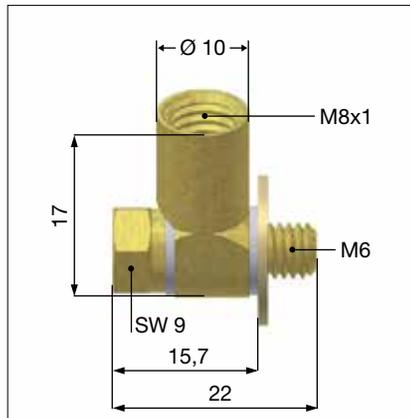

Swivel screw connection SV 6-M6-L

Swivel screw connection M 6 long
(aluminum sealing)

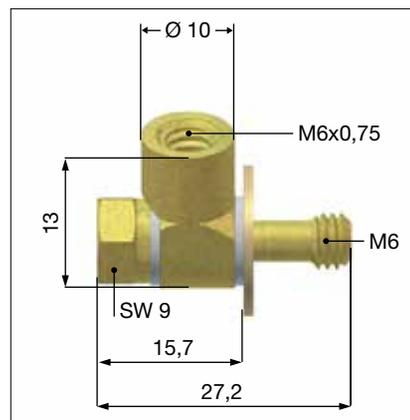

Swivel screw connection SV 6-M8-L

Swivel screw connection M 8 long
(aluminum sealing)

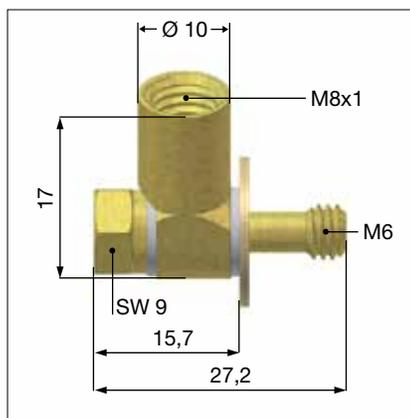

General area of application under normal conditions of use

Movement	MR	BM
Maximum speed	3 m/s	5 m/s
Maximum acceleration	50 m/s ²	100 m/s ²

Higher values are permissible, but are dependent on the type of carriage, lubrication, position when installed, pretension and load. If this is the case, please contact a SCHNEEBERGER agency before proceeding.

Working environment	MR	BM
Working temperature	-40°C - +80°C	-40°C - +80°C
Storage temperature	-40°C - +80°C	-40°C - +80°C
Vibration / impact	30 g	30 g

Materials

Rail	Roller bearing steel, hardened surfaces
Carriage	Roller bearing steel, fully hardened
Rolling element	Roller bearing steel, fully hardened
Synthetic parts	POM, PAPA, TPU injection moulded

Special characteristics

The product concept for BZ MONORAIL guides provides for the manufacture of one-piece section rail guides with integral racks up to 6 metres in length. These one-piece modules can be linked together to make axes of any length.

A prerequisite for this is that the butt transition joints are machined in a process specially developed for this purpose. The individual parts are installed and aligned using fixtures that are available separately.

Special cross-members are available for the safe transportation of the long individual rails. These aluminium trusses are designed to remain attached to the component while the toothed rail is installed and aligned and only finally removed after the latter has been finally fixed in place. This ensures that the rack can be safely transported, fitted and aligned without suffering any deformation.

In comparison to other screwed systems, BZ has a large number of connections between the rack and the guide rail thanks to the use of BM MONORAIL guides with fixing holes spaced half the normal distance apart. This means that very high lateral forces can be absorbed and compact designs with a high power density are possible. For details see SCHNEEBERGER application catalog

Tooth quality

SCHNEEBERGER MONORAIL BZ guideways are fitted with integral racks. The gearing used is specially designed for machine tool applications. 19°31'42" helical gearing using module 2.5 and module 2.0 is employed to reduce noise and to achieve smooth running.

Dependent on customers' requirements, the teeth can be formed in two different qualities

For details see SCHNEEBERGER application catalog.

Order code:

DIN quality 5, hardened and ground **-Q5H-**

DIN quality 6, soft, milled **-Q6S-**

Comparison with other drive systems

Compared with other drive solutions used for linear movements, rack drives with BZ MONORAIL offer a number of benefits.

Where ball screws are concerned, these are a way of implementing several independent movements on a guide system.

BZ MONORAIL has a superior drive rigidity, which is independent of the length of the axis and independent of temperature thanks to the modular style of construction.

The rack elements are partially exchangeable when worn.

Accurately machined section rail guides and exceptionally precise rack segments result in a very smooth running pinion. The preload of the drive system thus remains constant along the full length and does not change in operation over time.

In combination with suitable motors or gearboxes, self-locking vertical drives can be implemented in the event of power failure.

In comparison to linear motors, BZ MONORAIL systems represent an economical and simple alternative that offers a high degree of efficiency. They are the ideal solution when machining a wide range of materials on long axes and in the face of adverse operating conditions.

General technical data

General technical data q.v. chapter 2.1 Technical Data Guiding

2.3 Guiding and measuring Magneto-resistive measuring method

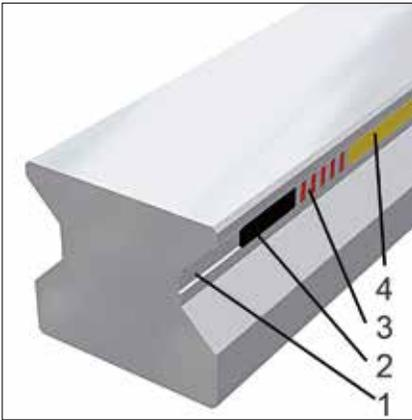

How the measuring scale is made

The measuring strip contains two magnetic tracks: the fine incremental track with alternate N & S poles spaced at 200 μm intervals, and the reference track to determine the absolute position. The reference track can either have distance coded marks, marks set at regular intervals or even with only a single reference mark.

The measuring strip is fully integrated into the rail section. It is manufactured by first grinding a slot (1) into the finished rail section into which a strip of magnetic material (2) is inserted. This magnetic material is ground and magnetised (3). To protect the scale, a through hardened cover strip, that is magnetically permeable is used and welded to the rail (4).

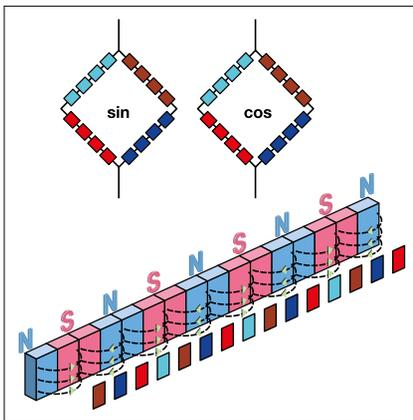

Magneto-resistive position sensor

A relative movement between the sensor and the scale, results in a change in field strength in the magneto-resistive material leading to a change in electrical resistance that can be easily measured. The electrical circuitry of the Wheatstone bridge sensor elements means that interference from fluctuations in temperature, ageing and magnetic interference fields are kept to a minimum.

Two sinusoidal shaped signals with a 90° phase shift are obtained from the incremental magnetisation as a result of the arrangement of the sickle-shaped sensor elements. To improve accuracy, the signals from 104 individual elements, in line with the direction of measurement, are averaged. As the structure of the sensor is adapted to the magnetic division period, the influence of magnetic interference is heavily suppressed.

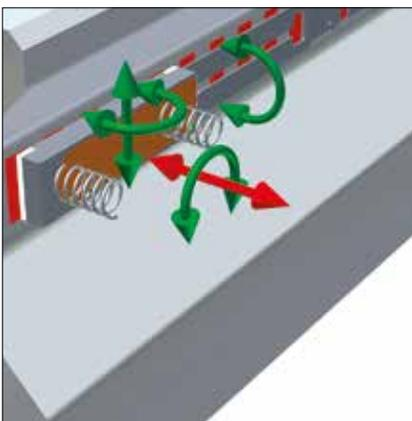

Positional independency of the sensor

All accuracy determining properties of the measuring signals (phase, differences in amplitude, harmonic wave characteristics, etc.) are anchored within the sensor. Therefore, even major deviations in position and twisting of the sensor do not lead to any reduction in signal quality: "The circuit remains stable."

The direct benefits are a simple exchange of the measuring head without any need for adjustment, enhanced resistance against vibration and shock as well as a wide tolerance band for the operation of the measuring heads.

2.3 Guiding and measuring Magneto-resistive measuring method

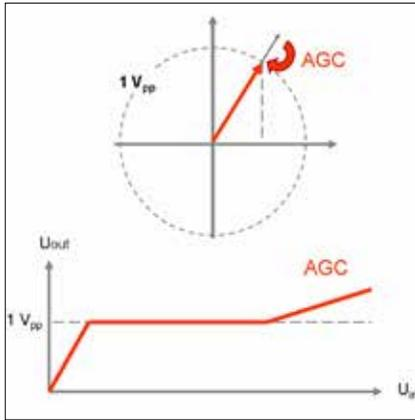

Operating method of automatic gain control (AGC)

The current amplitude (represented by the periodic signals) is continually determined in the electronic measuring system. In the event of any deviations, the amplitude is adjusted. Therefore, a standard output signal is provided even in exceptional cases (installation errors, external errors or removal of the slider).

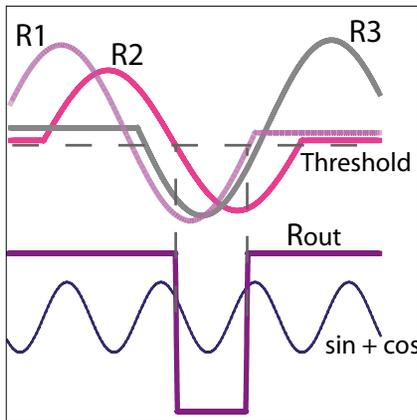

Reference point identification

The second track carries the AMS reference marks to determine the absolute position and reference the system. The accuracy of the reference points is decisive for the machine's zero or home position. A reference point is represented by three magnetic reference markers on the reference point magnetisation. The rising and falling flanks of the reference impulse each represent one piece of reference information. The third piece of reference information is redundant and is employed to increase the operational reliability of the reference point identification system. This operating principle thus suppresses any magnetic interference and, in dubious circumstances, does not provide a reference signal whenever any interference is encountered.

2.3 Guiding and measuring Features and options

Magnetization

AMS MONORAIL products are available with different reference marks that are surface-engraved by a laser. The illustration shows the position of the measuring carriage when registering the first reference mark.

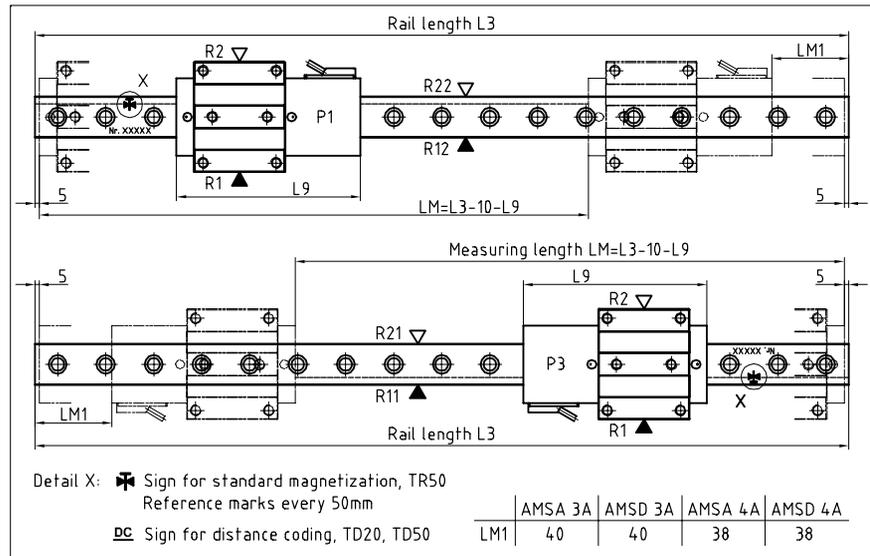

- TR50** AMS with 50mm reference mark grid.
- TD50** AMS with distance coded reference marks
Reference marks spaced at 50.2/49.8/50.4/49.6/50.6/49.4/./././... mm.
- TD20** AMS with distance coded reference marks
Further reference marks spaced at 20.2/19.8/20.4/19.6/20.6/19.4/./././...mm.
This option is only available on measuring lengths of up to 2.8 metres.

- Reference points, 50mm pattern
- Distance code, 50mm pattern
- Distance code, 20mm pattern

Reading head position and attachment sides

In the order designation, SCHNEEBERGER denotes the attachment position of the reading head, the position of the scale and the reference sides of rail and carriage as they are shown in the drawing above. For drawings in portrait format, the drawing shown must be rotated counter-clockwise by 90°. The following information must be included when placing an order:

Attachment side of the rail and scale position:

- R11 Reference bottom, scale bottom
- R12 Reference bottom, scale top
- R21 Reference top, scale bottom
- R22 Reference top, scale top

Reading head position:

- P1 External (mounting) housing right, reading head top
- P3 External (mounting) housing left, reading head bottom

Attachment side of carriage:

- R1 Reference bottom
- R2 Reference top

2.3 Guiding and measuring Read head interfaces

Interface TSU / TSD

12 pole round plug with union nut and female thread

Cable length: 3m



Interface TRU / TRD

12 pole round plug with male thread

Cable length: 3m



Interface TMU / TMD

12 pole round plug built in a mounting base

Cable length: 0,3m



2.3 Guiding and measuring Read head interfaces

Terminal layout

Contact	Interfaces TSU / TRU / TMU		Interfaces TSD / TRD / TMD	
	Signal	Signaltype	Signal	Signaltype
1	-Ua2	- Cosine	- Ua2	A quad B signal
2	+5V Sensor	Supply voltage feed back	+5V Sensor	Supply voltage feed back
3	+Ua0	Reference signal	+Ua0	Reference signal synchronized
4	-Ua0	Reference signal	- Ua0	Reference signal synchronized
5	+Ua1	+ Sine	+Ua1	A quad B signal
6	-Ua1	- Sine	- Ua1	A quad B signal
7	-Uas	NC	- Oas	Error signal active low, minimum duration 20 ms
8	+Ua2	+ Cosinue	+ Ua2	A quad B signal
9	-	NC	-	NC
10	0V (GND)	Supply voltage	0V (GND)	Supply voltage
11	0V Sensor	Supply voltage feed back	0V Sensor	Supply voltage feed back
12	+5 V	Supply voltage	+5 V	Supply voltage



Contact	Interface TRH / TMH	
	Signal	Signal type
1	+5V sensor	Supply voltage feedback
2	-	NC
3	-	NC
4	0V sensor	Supply voltage feedback
5	-	internal parameterisation
6	TxD	internal parameterisation
7	+5V oder 24V	Supply voltage
8	+CLK	+ Pulse
9	-CLK	- Pulse
10	0V (GND)	Supply voltage
11	-	inner screen
12	+Ua2	+ Cosine
13	- Ua2	- Cosine
14	+DATA	+ Data
15	+Ua1	+ Sine
16	- Ua1	- Sine
17	- DATA	- Data

2.3 Guiding and measuring Read head interfaces

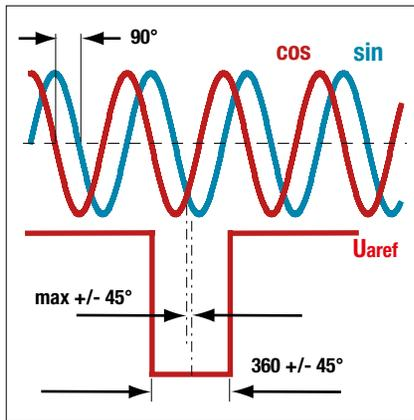

TSU/TRU/TMU analog voltage interfaces

The signals are shown inverted according to differential gain. The incremental signals are displaced by exactly 90° in their phasing. The levels after differential gain of the incremental signals and of the reference signals are 1 +/- 0.1 Vpp. The incremental signals supply valid values between 0.6 Vpp and 1.2 Vpp.

On production standards, the reference pulse is set symmetrically to the intersection of sine and cosine (at 45°). The width and the phasing of the reference pulse is limited as shown in the illustration. On the receiver side, the precision of the reference mark can thus be increased by the additional use of the incremental information.

This interface works with all standard control systems that support a 1 Vpp voltage interface.

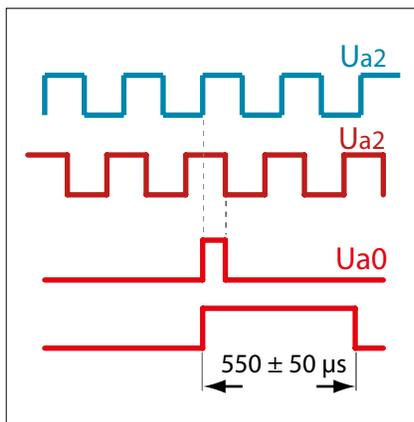

TSD/TRD/TMD digital interfaces

The incremental signals A+, A-, B+, B- and the reference signals R+, R- transmit the data complementary according to RS 422. The illustration shows the positive signals. The levels of the individual signals are:

High > 2,5 V Low < 0,5 V

Rise and fall times are less than 20 ns. The minimum signal distances can be calculated from the maximum output frequency. The downstream electronics must be able to process the maximum output frequency without any problems.

Option **ZN**: The reference pulse is strictly synchronised with the incremental signals.

Option **ZF**: The reference pulse is extended to 550 µs +/- 50 µs. This option is used with evaluation electronics that cannot process multiple short-term reference impulses

The following combinations of **interpolation factor**, **maximum output frequency** and **reference impulse implementation** are available for all reading head interfaces.

- 010-80-ZN 5 µm, interpolation 10x, max. output frequency 8 MHz
- 050-80-ZN 1 µm, interpolation 50x, max. output frequency 8 MHz
- 250-80-ZN 0,2 µm, interpolation 250x, max. output frequency 8 MHz
- 010-80-ZF 5 µm, interpolation 10x, max. output frequency 8 MHz
- 050-80-ZF 1 µm, interpolation 50x, max. output frequency 8 MHz
- 250-80-ZF 0,2 µm, interpolation 250x, max. output frequency 8 MHz

Order code:

-010-80-ZN- interpolation 10fach, max. output frequency 8 MHz, reference impulse standard

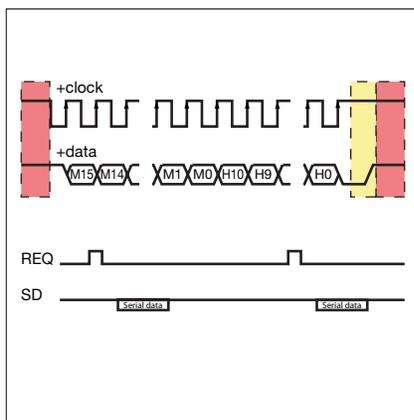

Absolute interfaces TRH / TMH

The absolute information can be transferred via fully digital interfaces, or via hybrid ones.

In the case of the fully digital SSI interface, the first channel (+pulse) sends a clock signal from the receiver to the measuring system; the second channel (+data) simultaneously sends the absolute position values from the measuring system to the sequential electronics unit.

Another example is the fully digital "Fanuc Serial Interface". The motor controller simply sends a request signal (REQ), rather than a pulse. From this, the measuring system calculates the clock rate, which it uses to send the position data and the supplementary data (SD) to the receiver.

The SSI+SinCos hybrid interface only sends the digital absolute initial position when it is switched on, and from then on it sends incremental additional 1 Vpp signals.

The SSI interface can be connected to any commercial controller with an SSI interface. The "Fanuc Serial Interface" is designed for a Fanuc controller, and the SSI+SinCos interface is designed for a Siemens controller.

2.3 Guiding and measuring Accessories - Cables

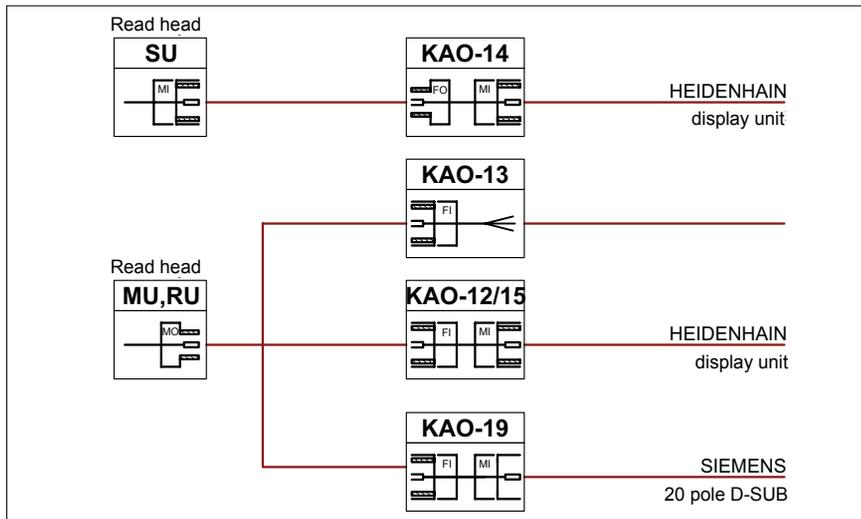

Cable for analog reading heads

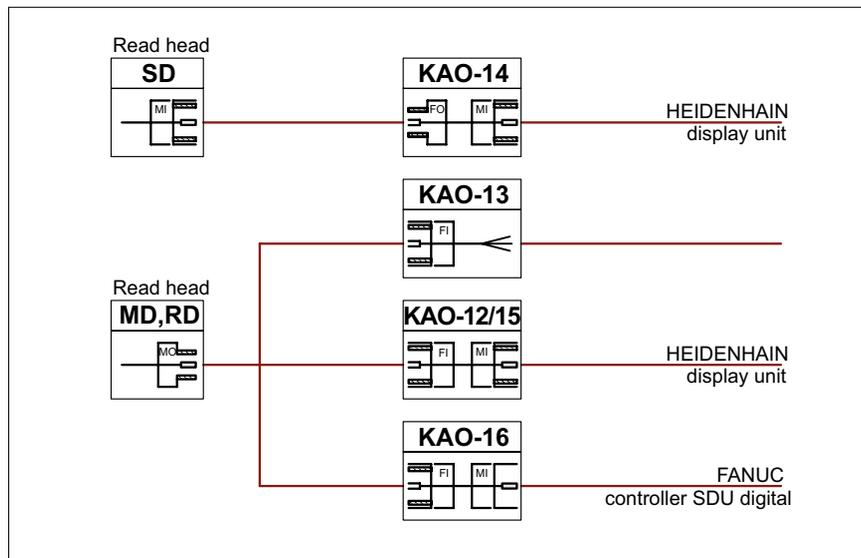

Cable for digital reading heads

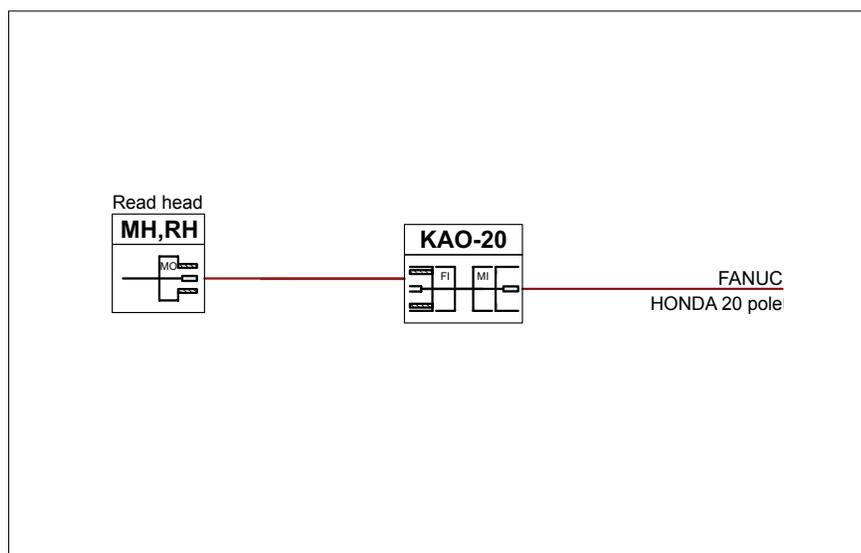

Cable for absolute reading heads

2.3 Guiding and measuring Accessories - Cables

KAO 12

Connecting cable, 12 pole, socket with female thread - plug with female thread

Order code: **KAO 12-xx**

xx = length in m, available lengths
3, 5, 10, 15 and 20m

Order example: KAO 12-5

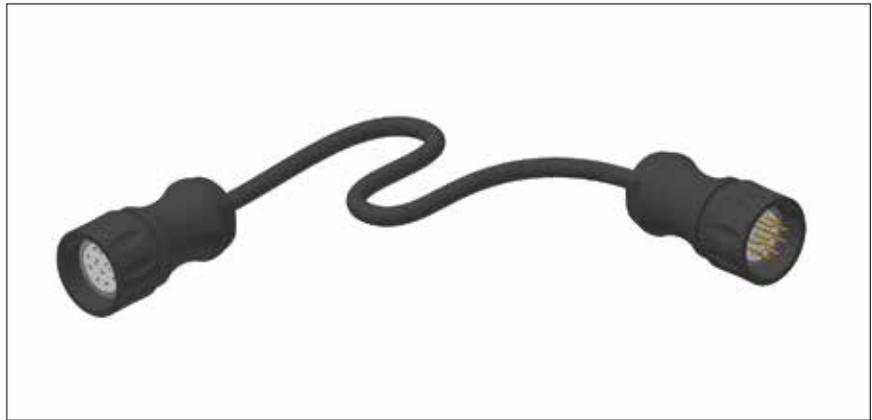

KAO 13

Connecting cable, 12 pole, socket with female thread - open ends

Order code: **KAO 13-xx**

xx = length in m, available lengths
3, 5, 10, 15 and 20m

Order example: KAO 13-5

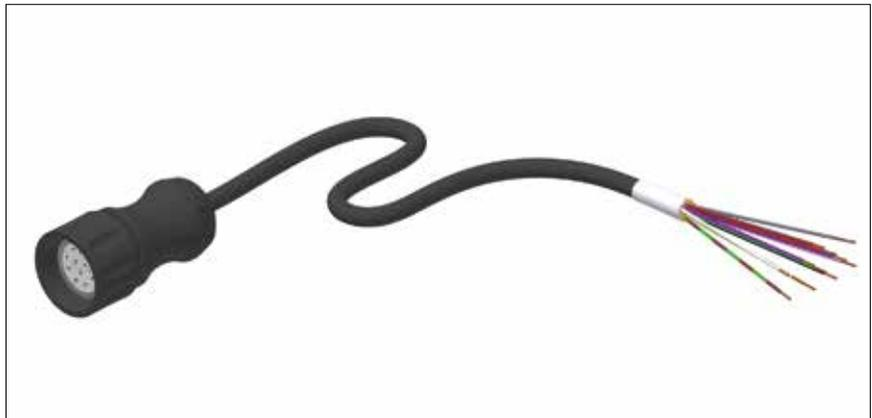

KAO 14

Extension cable, 12 pole, socket with male thread - plug with female thread

Order code: **KAO 14-xx**

xx = length in m, available lengths
3, 5, 10, 15 and 20m

Order example: KAO 14-5

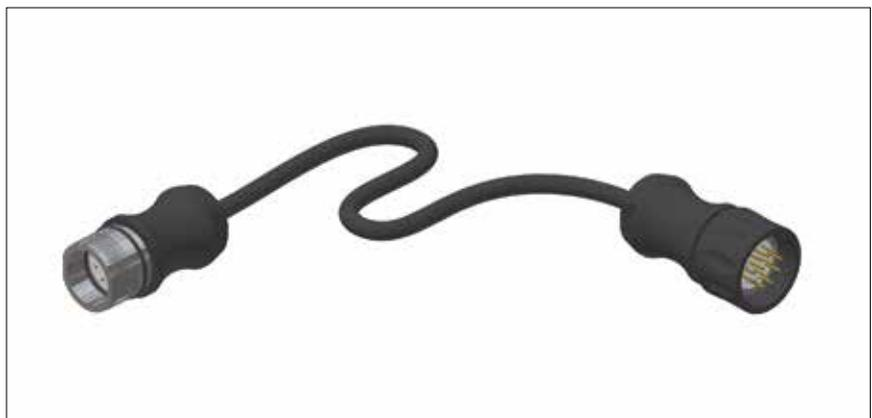

KAO 15

Extension cable, 12 pole, socket with female thread - plug with male thread

Order code: **KAO 15-xx**

xx = Length in m, available lengths
3, 5, 10, 15 und 20m

Order example: KAO 15-5

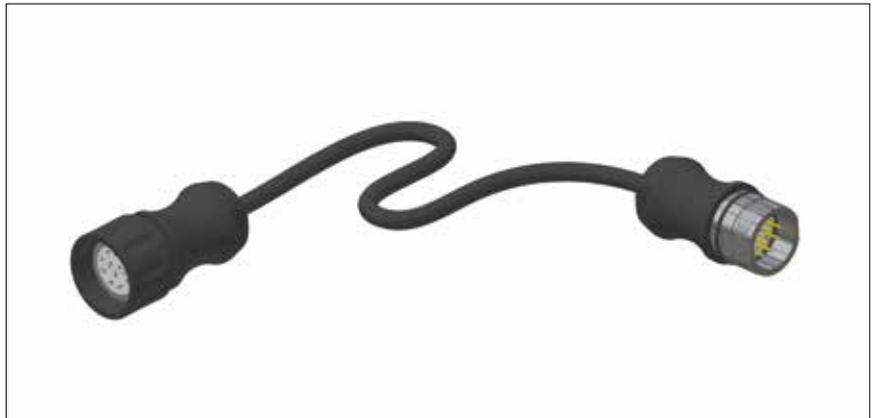

KAO 16 for FANUC analog

Connecting cable, 12 pole, socket with female thread - FANUC plug

Order code: **KAO 16-xx**

xx = length in m, available lengths
3, 5, 10, 15 and 20m

Order example: KAO 16-5

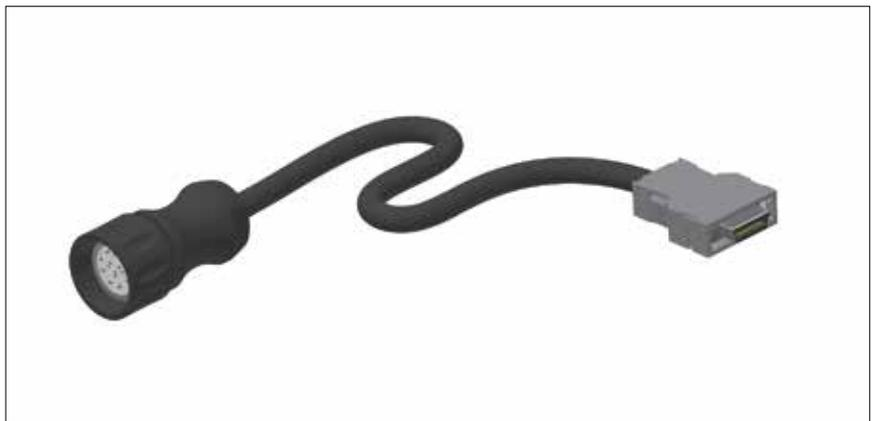

KAO 19 for SIEMENS analog

Connecting cable, 12 pole, socket with female thread - D-SUB plug

Order code: **KAO 19-xx**

xx = length in m, available lengths
3, 5, 10, 15 and 20m

Order example: KAO 19-5

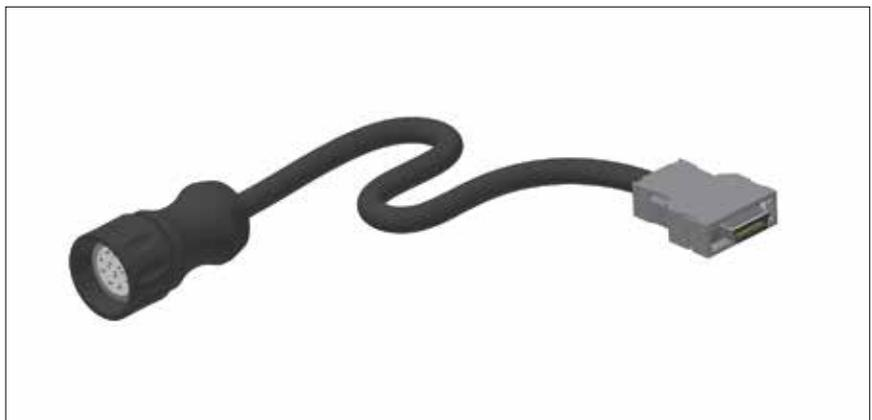

KAO 20 für FANUC absolut

Connecting cable, 17 pole, socket with female thread - HONDA plug

Order code: **KAO 20-xx**

xx = length in m, available lengths
3, 5, 10, 15 and 20m

Order example: KAO 20-5

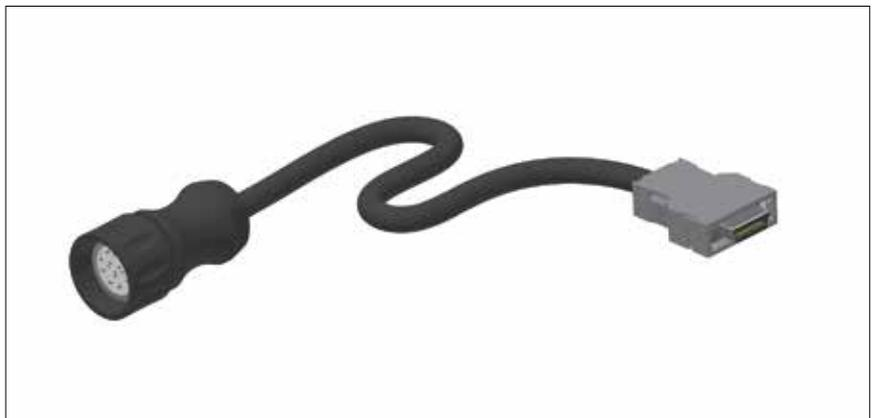

2.3 Guiding and measuring Dimensions reading head

AMS 3B/4B

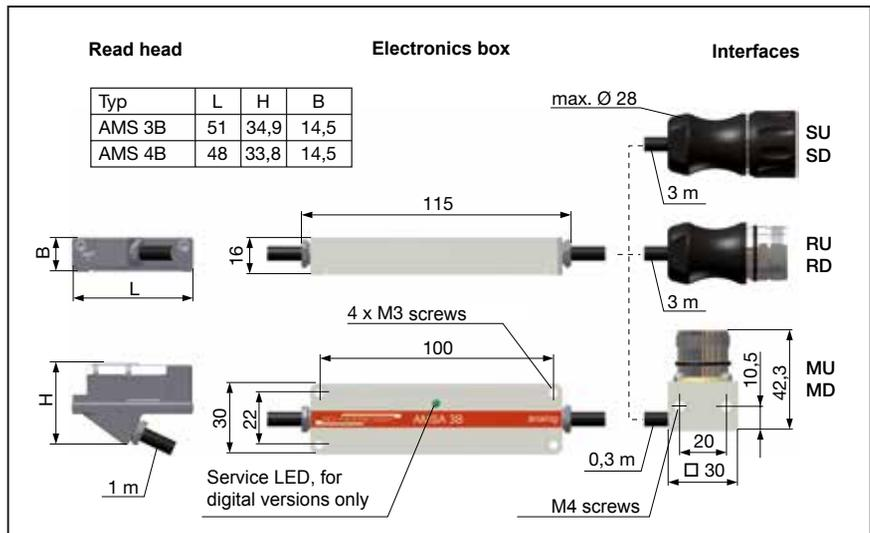

AMSABS 3B/4B

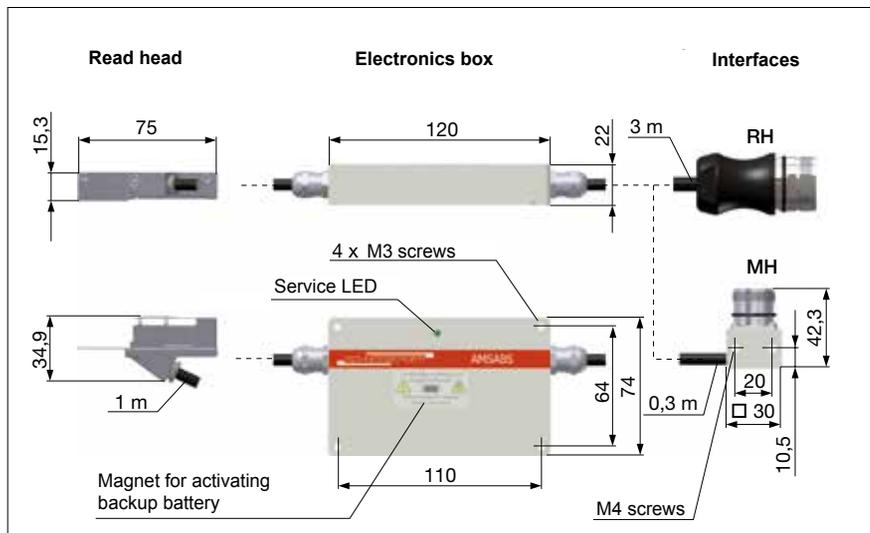

AMSA 3L

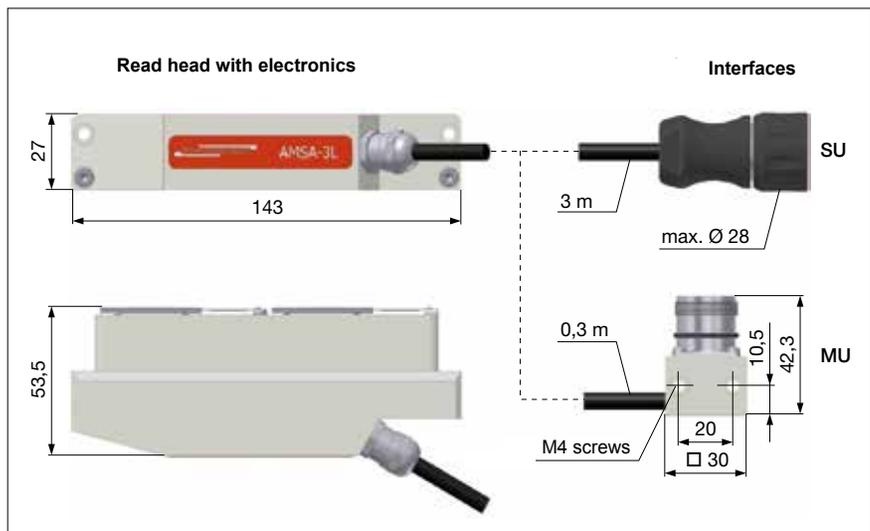

System properties

Material measure	Magnetically hard periodic N-S graduation
Signal period	200 µm
Working environment	
Protection class	IP 68
Working temperature	0°C - +70°C
Storage temperature	-20°C - +70°C
Vibration / impact	30 g

AMSA 3B und AMSA 4B

Accuracy

Accuracy class	+/- 5 µm / 1000 mm +/- 2 µm / 40 mm
Periodic deviation	+/- 0,7 µm
Resolution	max. 0,0625 µm
Hysteresis	< 0,5 - 1 µm

Interfaces

Analog	Voltage interface 1 Vpp
Supply voltage	5 V +/- 0,25 V
Current consumption	40 mA per reading head

AMSD 3B und AMSD 4B

Accuracy

Accuracy class	+/- 5 µm / 1000 mm +/- 2 µm / 40 mm
Periodic deviation	+/- 0,1 µm
Resolution	0,2 µm / 1,0 µm / 5,0 µm
Hysteresis	< 0,5 µm or digitally adjustable

Interfaces

Digital	Quadratur signals RS 422 with reference and error signals Reference pulse width 90° or 500 µs, ± 50 µs (for FANUC-CNC)
Supply voltage	5 V +/- 0,25 V
Current consumption	110 mA per reading head

2.3 Guiding and measuring General technical data

AMSABS 3B und 4B

Accuracy

Accuracy level	+/- 5 µm / 1000 mm +/- 2 µm / 40 mm
Periodic deviation	+/- 0,7 µm
Hysteresis	0,5µm – 1µm

Interfaces

Fully digital	e.g. cycle synchronous serial interface (SSI) or FANUC serial interface
Supply voltage	5 V ± 10% oder 24 V ± 10%
Current consumption	< 200 mA Ausgänge unbelastet
Resolution absolute	max. 0,977 µm
Hybrid	cycle synchronous serial interface with analogue voltage interface 1 Vpp
Supply voltage	5 V ± 10% oder 24 V ± 10%
Current consumption	< 200 mA Outputs unloaded
Resolution absolute	max. 0,0977 µm
Resolution analog	max. 0,0625 µm

AMSA 3L

Measuring element	Magnetically hard division
Signal period	200 µm
Reference marks	Synchronised to bore grid
Length	Standardised ≈ 3 m
Speed	1 m/s
Accuracy	$\Delta X_{pp} = \pm 7 \mu\text{m}$, $\Delta X_{s1s2} = \pm 5 \mu\text{m}$
Accuracy class	+/- 5 µm / 1000 mm +/- 2 µm / 40 mm
Working environment	
Protection class	IP 67
Operating temperature	0° - 70° C
Storage temperature	-20° - 70° C
Vibration / Shock	10 g

ΔX_{s1s2} : Features of the read head
 ΔX_{pp} : max. deviation (the sum of all deviations)

2.4 Ordering information Order code and examples

Rails, carriages and accessories are always denoted by separate order codes. This also applies to different versions of rails and carriages.

The order codes for individual rails, carriages and accessories are in the data section of this catalogue from section 3 on. An attempt has been made here to code all versions by position in order to reduce the error rate in the ordering procedure.

Please use the following order schedule for orders that are to be supplied preassembled:

Order code for MONORAIL systems

Set consisting of:

/ n x S

/ n x W

/ n x W (optional)

/ n x S (optional)

/ n x W (optional)

/ n x Z

NB

S = complete order code for a rail

W = complete order code for a carriage

Z = complete order code for an accessory

"/" = indicates everything that belongs to a set in an order

n = number, indicates products of the same type

If no customer-related information is available, the rails and carriages are assembled in accordance with the sequence of the items ordered, i.e. the first rail at the top followed by the carriages on the first rail from left to right; then the second rail below it with the carriages from left to right et cetera, cf example 2.

This means that - if rail types and carriage types are different in the order placed - the carriages are always immediately below the relevant rail and in the assembly sequence from left to right.

Example 1: Order without a layout sketch - same types of component

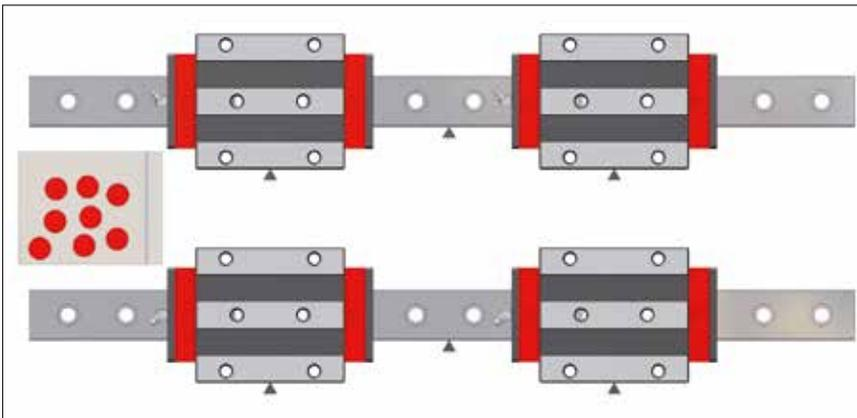

2 identical rails each with 2 identical carriages, accessories (additional wipers) can be clearly allocated due to the number.

Plugs for the rails are always supplied unfitted.

Set consisting of:

/ 2 x MR S 35-N-G1-KC-R1-918-19-19-CN

/ 4 x MR W 35-B-G1-V3-R1-CN-S10-LN

/ 2 x MRK 35 (50 pieces)

/ 8 x ZCN 35

/ 4 x SN 6-45

2.4 Ordering information Order code and examples

Example 2: Order without a layout sketch - different types of component

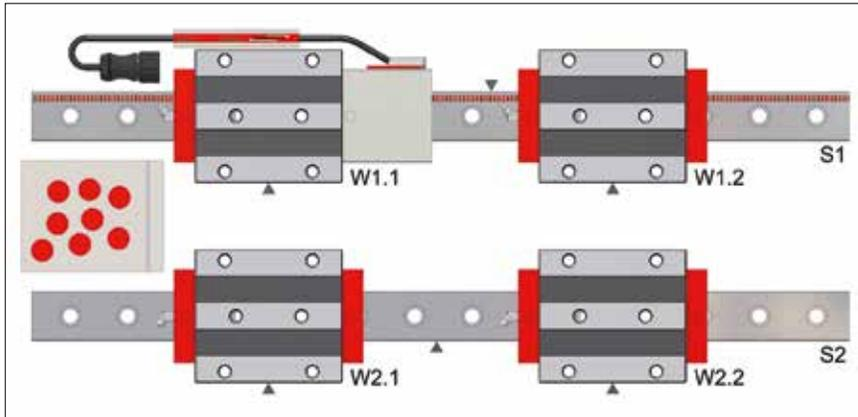

2 different rails and 2 different carriage types, uniform lubrication accessories, allocation and sequence of rails and carriages acc. to the sequence of the items in the order.

Set consisting of:

- / 1 x AMSA 3B S 35-N-G1-KC-R22-918-19-19-CN-TR50 (S1)
- / 1 x AMSA 3B W 35-B-P1-G1-V3-R1-CN-S10-LN-TSU (W1.1)
- / 1 x MR W 35-B-G1-V3-R1-CN-S10-LN (W1.2)
- / 1 x MR S 35-N-G1-KC-R1-918-19-19-CN (S2)
- / 2 x MR W 35-B-G1-V3-R1-CN-S10-LN (W2.1 + W2.2)
- / 2 x MRK 35 (50 Stück)
- / 4 x SN 6-45

Example 3: Order according to customer's layout sketch - different components

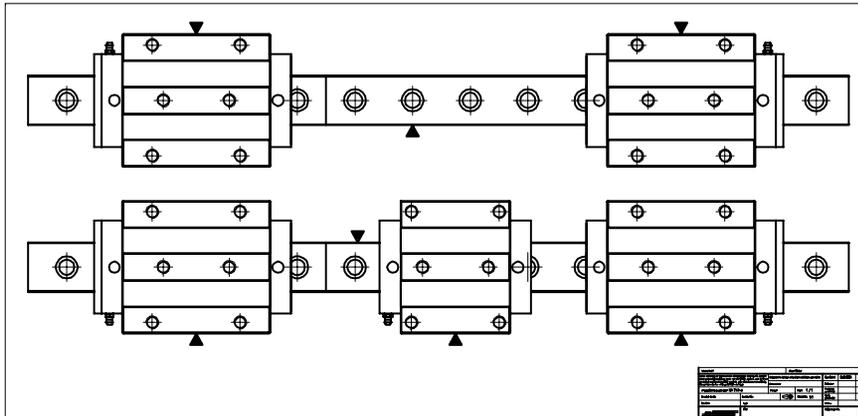

2 different rails, 2-part in each case, 5 different carriages. The rails, carriages and accessories are impossible to allocate clearly without a layout sketch.

Set consisting of:

- / 1 x MR S 35-ND-G1-KC-R1-2478-19-19-CN (Teillängen L3 = 999mm/1479mm)
- / 1 x MR W 35-B-G1-V3-R2-CN-S13-LN
- / 1 x MR W 35-B-G1-V3-R2-CN-S23-LN
- / 1 x MR S 35-ND-G1-KC-R2-2478-19-19-CN (Teillängen L3 = 999mm/1479mm)
- / 1 x MR W 35-B-G1-V3-R1-CN-S12-LN
- / 1 x MR W 35-A-G1-V3-R1-CN-S12-LN
- / 1 x MR W 35-B-G1-V3-R1-CN-S22-LN
- / 5 x MRK 35 (125 Stück)
- / 4 x ZCN 35
- / 5 x SN 6

Important:

Apart from the order designation, further information is required for the troublefree order processing of special versions of MONO-RAIL systems. For this purpose, the order must include a layout sketch containing the following information:

- Part-lengths and the sequence of the segments for multipart rails
- Carriage type and position in the event of different carriage types on one rail
- Position of additional wipers, lubricating panels and lubricating accessories

Please note the following pointers to ensure that your MONORAIL guideways remain in peak working condition throughout their service life:

All SCHNEEBERGER products are precision components that are appropriately protected and packaged at the factory for the purpose of transport. Systems must therefore be protected from vibrations, shock and humidity when being transported and stored.

Please note the pointers on transport and installation that accompany the measuring systems.

Installation of the guideways and the covering of the holes in the rails must be carried out by qualified staff. Please refer to the Download section of www.schneeberger.com for pointers on installation.

Guideways must be adequately supplied with a lubricant that is suited to their movements and load profile as well as to the conditions under which they are expected to operate. If necessary, please contact a lubricant supplier, who will be pleased to advise you on the choice of the correct lubricant. Recommendations will also be found at www.schneeberger.com.

Prior to use, the compatibility of coolants and lubricants must be checked and verified by the user in order to preclude any detrimental effect(s) on the guideway. To protect them from dirt, hot metal chips and any direct contact with coolants, guideways should have covers fitted or be appropriately positioned.

If contact with dirt or coolant is anticipated in the course of machining operations, the fitting of additional wipers to the products is necessary. The long-term serviceability of these components must be assured by amended service intervals. Please refer to www.schneeberger.com for pointers on these products.

If the guideway gets into contact with hot chips an additional use of wipers is recommended. For further information please visit www.schneeberger.com.

The wipers on the ends as well as the additional wipers fitted to MONORAIL carriages must be examined at regular intervals for wear and tear and replaced if necessary.

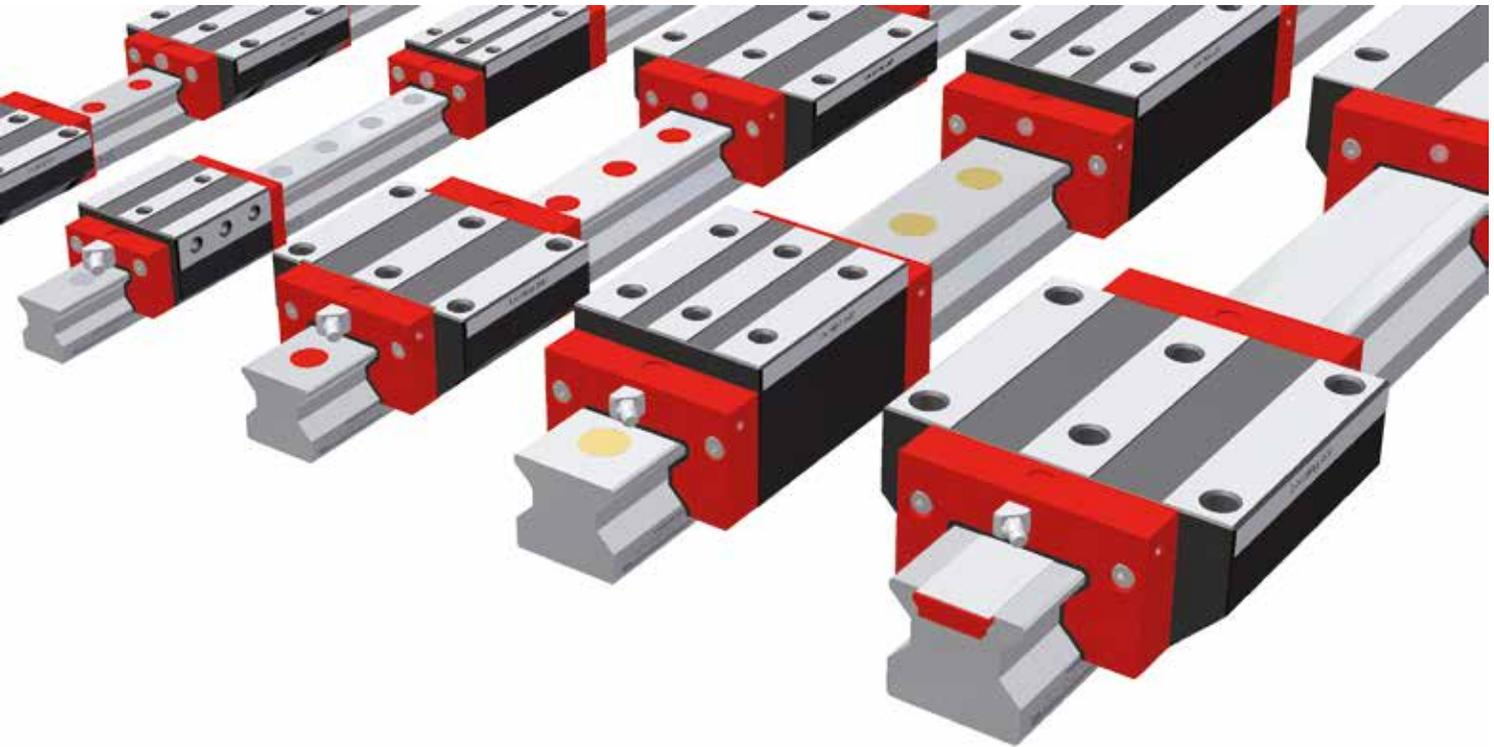

Exceptional rigidity, high dynamic and static load-carrying capacities, outstanding smooth running and a fully sealed carriage are the main features of the MONORAIL MR Roller Guideway. Specifically designed for machine tools, these properties result in higher machining rates plus enhanced geometrical accuracy and surface quality of the machined component. The exceptional all-round rigidity of the products and the method of connection with the surrounding structure provide improved vibration behaviour at lower amplitudes therefore extending tool life.

Many years of experience in the design, production and use of roller-type guideways as well as the most advanced technologies in product development and volume production are consistently applied and continuously improved. The MONORAIL MR Guideway is a cost-effective solution that meets the demands of modern machine-tool design.

Features of System MONORAIL MR



Details see chapter 1

3.1 Overview of types, sizes and available options

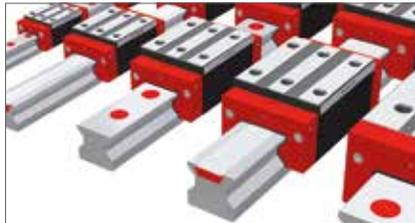

Product overview MR Rails	Page 38
Product overview MR Carriages	Page 39

3.2 Technical data and options

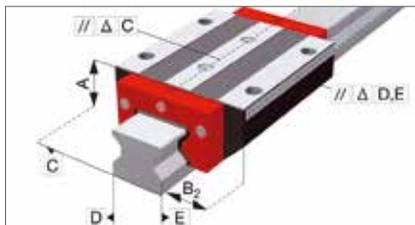

MR Buildsize 25	Page 40
MR Buildsize 35	Page 42
MR Buildsize 45	Page 44
MR Buildsize 55	Page 46
MR Buildsize 65	Page 48
MR Buildsize 100	Page 50

3.3 Accessories MONORAIL MR



Accessories overview	Page 52
MR Rails accessory details	Page 53
MR Carriages accessory details	Page 56

3.4 Order key

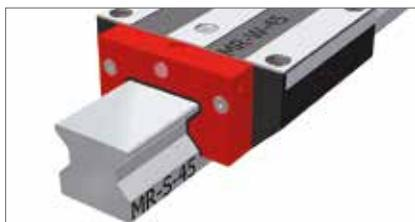

Order key MR Rails	Page 59
Order key MR Carriages	Page 59

Product overview MR Rails



	N standard	ND standard, through hardened	NU with tapped holes at the bottom	NUD with tapped holes, through hardened	C for cover strip	CD for cover strip, through hardened	
Buildsizes / Rail build forms							
Size 25	MR S 25-N	MR S 25-ND	MR S 25-NU		MR S 25-C	MR S 25-CD	
Size 35	MR S 35-N	MR S 35-ND	MR S 35-NU	MR S 35-NUD	MR S 35-C		
Size 45	MR S 45-N	MR S 45-ND	MR S 45-NU		MR S 45-C		
Size 55	MR S 55-N		MR S 55-NU		MR S 55-C		
Size 65	MR S 65-N		MR S 65-NU		MR S 65-C		
Size 100	MR S 100-N						
Features							
Screwable from above	●	●			●	●	
Screwable from below			●	●			
Small assembly effort			●	●	●	●	
Great single-part system length	●		●		●		
Usable for bombardment with metal chips				●			
For the support of metal covers		●		●			

Available options for MR Rails

Details see chapter 2

Accuracy

- G0 Highly accurate
- G1 Very accurate
- G2 Accurate
- G3 Standard

Straightness

- KC Standard

Reference side

- R1 Ref. at bottom
- R2 Ref. on top

Coating

- CN None
- CH Hard chromium

Available accessories for MR Rails

Details see chapter 3.3

Plugs

Cover strips

Assembly tools

3.1 Overview of types, sizes and available options

MR Carriages

Product overview MR Carriages

							
	A standard	B standard, long	C compact, high	D compact, high, long	E compact, high, for lateral fixation	F compact	G compact, long
Buildsizes / Carriage build forms							
Size 25	MR W 25-A	MR W 25-B	MR W 25-C	MR W 25-D	MR W 25-E	MR W 25-F	MR W 25-G
Size 35	MR W 35-A	MR W 35-B	MR W 35-C	MR W 35-D	MR W 35-E		
Size 45	MR W 45-A	MR W 45-B	MR W 45-C	MR W 45-D		MR W 45-F	
Size 55	MR W 55-A	MR W 55-B	MR W 55-C	MR W 55-D			MR W 55-G
Size 65	MR W 65-A	MR W 65-B	MR W 65-C	MR W 65-D			
Size 100		MR W 100-B					
Features							
Screwable from above	●	●	●	●		●	●
Screwable from below	●	●					
Screwable from the side					●		
For high loads and moments		●		●			●
For medium loads and moments	●		●		●	●	
For limited installation space						●	●

Available options for MR Carriages

Details see chapter 2

Accuracy

-  G0 Highly accurate
-  G1 Very accurate
-  G2 Accurate
-  G3 Standard

load

-  V1 Low
-  V2 Medium
-  V3 High

Reference side

-  R1 Anschlag unten
-  R2 Ref. on top

Coating

-  CN None
-  CH Hard chromium

Lube connections

-  S10 Left center
-  S20 Right center
-  S11 Top left
-  S21 Top right
-  S12 Lower left side
-  S22 Lower right side

-  S13 Upper left side
-  S23 Upper right side
-  S32 Left side
-  S42 Right side
-  S60 Center

Lubricationw

-  LN Oil protect
-  LG Grease protect
-  LV Full greasing

Available accessories for MR Carriages

Details see chapter 3.3 and 2.1

Additional wipers
Front plates

Bellows
Lube nipples

Assembly rails
Lube adapters

Lubrication plates

3.2 Technical data and options

MR Size 25

MR S 25 Dimensions



	MR S 25-N	MR S 25-ND	MR S 25-NU	MR S 25-C	MR S 25-CD
B1: Rail width	23	23	23	23	23
J1: Rail height	24.5	24.5	24.5	24.5	24.5
L3: Rail length max.	6000	1500	6000	3000	1500
L4: Spacing of fixing holes	30	30	30	30	30
L5/L10: Position of first/last fixing hole	13.5	13.5	13.5	13.5	13.5
Gew.: Rail weight, specific (kg/m)	3.4	3.4	3.8	3.3	3.3

Available options for MR S 25



MR W 25 Dimensions and capacities



	MR W 25-A	MR W 25-B	MR W 25-C	MR W 25-D	MR W 25-E	MR W 25-F	MR W 25-G
A: System height	36	36	40	40	40	36	36
B: Carriage width	70	70	48	48	57	48	48
B2: Distance between locating faces	23.5	23.5	12.5	12.5	17	12.5	12.5
C1: Position of center front lube hole	5.5	5.5	9.5	9.5	9.5	5.5	5.5
C3: Position of lateral lube hole	-	-	-	-	-	-	-
C4: Position of lateral lube hole	-	-	-	-	-	-	-
C7: Position of top lube hole	12	23.2	17	20.7	17	17	20.7
J: Carriage height	29.5	29.5	33.5	33.5	33.5	29.5	29.5
L: Carriage length	81	103.4	81	103.4	81	81	103.4
L1: Exterior fixing hole spacing	45	45	35	50	35	35	50
L2: Interior fixing hole spacing	40	40	-	-	35	-	-
L6: Steel body length	60	79.4	57	79.4	57	57	79.4
N: Lateral fixing hole spacing	57	57	35	35	-	35	35
O: Reference face height	7.5	7.5	7.5	7.5	15	7.5	7.5
Capacities and weights							
C0: Static load capacity (N)	49800	70300	49800	70300	49800	49800	70300
C100: Dynamic load capacity (N)	27700	39100	27700	39100	27700	27700	39100
MOQ: Static cross moment capacity (Nm)	733	1035	733	1035	733	733	1035
MOL: Static longitud. moment capacity (Nm)	476	936	476	936	476	476	936
MQ: Dyn. cross moment capacity (Nm)	408	576	408	576	408	408	576
ML: Dyn. longitud. moment capacity (Nm)	265	521	265	521	265	265	521
Gew.: Carriage weight (kg)	0.7	0.9	0.6	0.7	0.7	0.5	0.6

Available options for MR W 25



3.2 Technical data and options

MR Size 35

MR S 35 Dimensions



	MR S 35-N	MR S 35-ND	MR S 35-NU	MR S 35-NUD	MR S 35-C
B1: Rail width	34	34	34	34	34
J1: Rail height	32	32	32	32	32
L3: Rail length max.	6000	1500	6000	1500	6000
L4: Spacing of fixing holes	40	40	40	40	40
L5/L10: Position of first/last fixing hole	18.5	18.5	18.5	18.5	18.5
Gew.: Rail weight, specific (kg/m)	6.5	6.5	7.1	7.1	6.3

Available options for MR S 35



MR W 35 Dimensions and capacities



	MR W 35-A	MR W 35-B	MR W 35-C	MR W 35-D	MR W 35-E
A: System height	48	48	55	55	55
B: Carriage width	100	100	70	70	76
B2: Distance between locating faces	33	33	18	18	21
C1: Position of center front lube hole	7	7	14	14	14
C3: Position of lateral lube hole	7	7	14	14	14
C4: Position of lateral lube hole	17	30.5	23	25.5	23
C7: Position of top lube hole	14	27.5	20	22.5	20
J: Carriage height	40	40	47	47	47
L: Carriage length	109	136	109	136	109
L1: Exterior fixing hole spacing	62	62	50	72	50
L2: Interior fixing hole spacing	52	52	-	-	50
L6: Steel body length	80	103	76	103	76
N: Lateral fixing hole spacing	82	82	50	50	-
O: Reference face height	8	8	8	8	22
Capacities and weights					
C0: Static load capacity (N)	93400	128500	93400	128500	93400
C100: Dynamic load capacity (N)	52000	71500	52000	71500	52000
MOQ: Static cross moment capacity (Nm)	2008	2762	2008	2762	2008
MOL: Static longitud. moment capacity (Nm)	1189	2214	1189	2214	1189
MQ: Dyn. cross moment capacity (Nm)	1118	1537	1118	1537	1118
ML: Dyn. longitud. moment capacity (Nm)	662	1232	662	1232	662
Gew: Carriage weight (kg)	1.6	2.2	1.5	2.0	1.8

Available options for MR W 35



MR S 45 Drawings

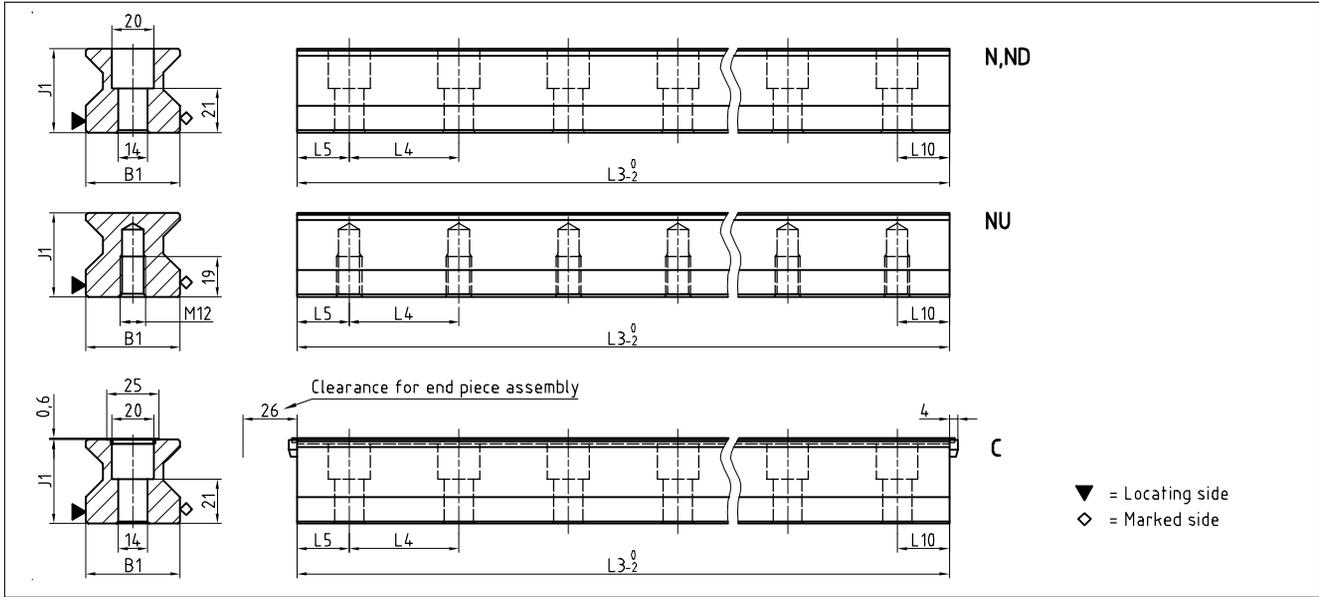

MR W 45 Drawings

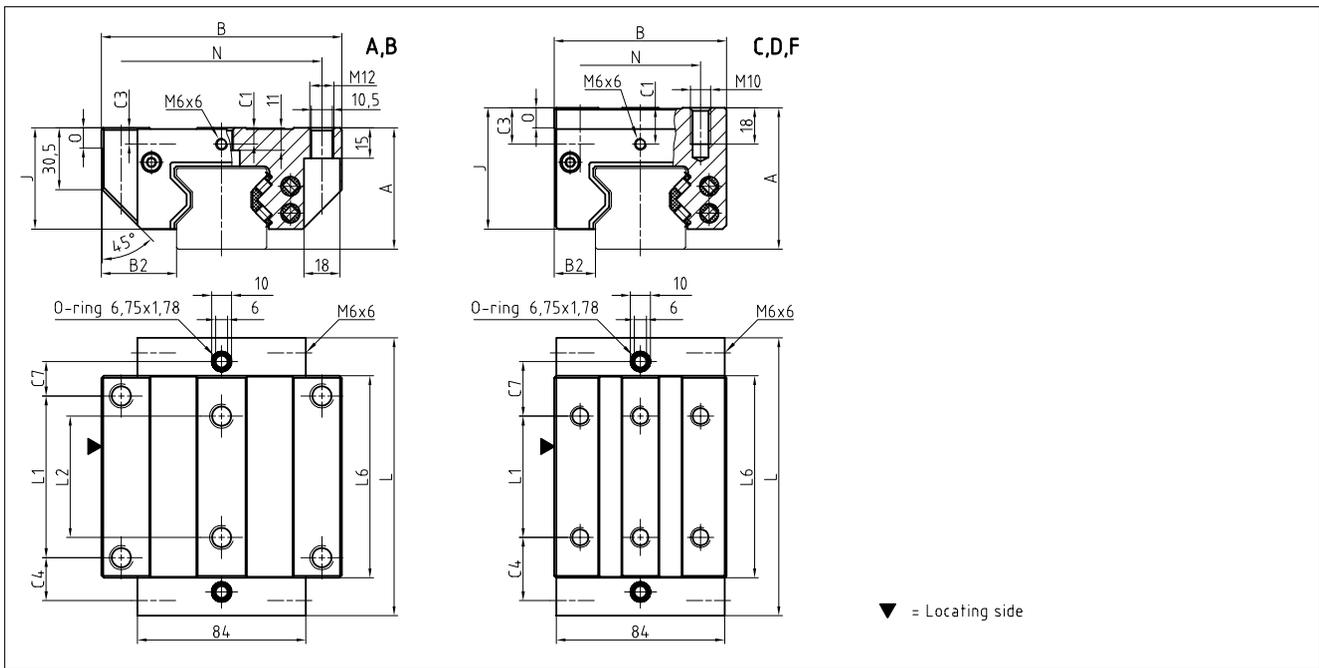

MR W 45 Rigidity diagram

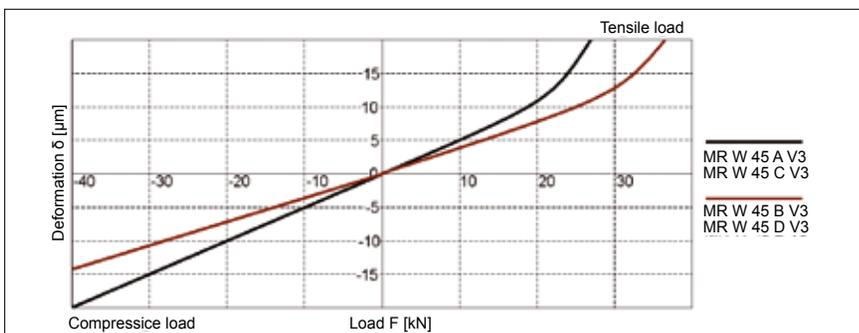

MR W 45 Load rating

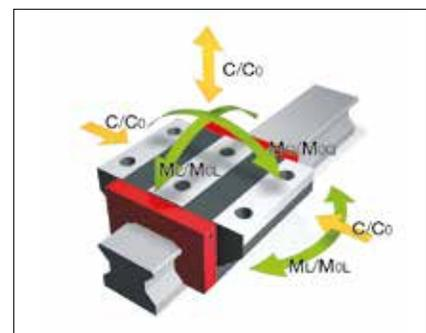

3.2 Technical data and options

MR Size 45

MR S 45 Dimensions

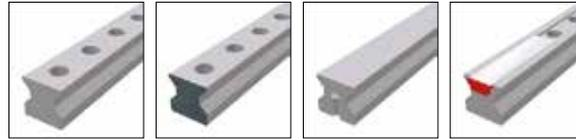

	MR S 45-N	MR S 45-ND	MR S 45-NU	MR S 45-C		
B1: Rail width	45	45	45	45		
J1: Rail height	40	40	40	40		
L3: Rail length max.	6000	1500	6000	6000		
L4: Spacing of fixing holes	52.5	52.5	52.5	52.5		
L5/L10: Position of first/last fixing hole	25	25	25	25		
Gew.: Rail weight, specific (kg/m)	10.8	10.8	11.8	10.6		

Available options for MR S 45



MR W 45 Dimensions and capacities



	MR W 45-A	MR W 45-B	MR W 45-C	MR W 45-D	MR W 45-F		
A: System height	60	60	70	70	60		
B: Carriage width	120	120	86	86	86		
B2: Distance between locating faces	37.5	37.5	20.5	20.5	20.5		
C1: Position of center front lube hole	8	8	18	18	8		
C3: Position of lateral lube hole	8	8	18	18	8		
C4: Position of lateral lube hole	21.25	38.75	31.25	38.75	31.25		
C7: Position of top lube hole	17	34.5	27	34.5	27		
J: Carriage height	50	50	60	60	50		
L: Carriage length	137.5	172.5	137.5	172.5	137.5		
L1: Exterior fixing hole spacing	80	80	60	80	60		
L2: Interior fixing hole spacing	60	60	-	-	-		
L6: Steel body length	100	135	100	135	100		
N: Lateral fixing hole spacing	100	100	60	60	60		
O: Reference face height	10	10	10	10	10		
Capacities and weights							
C0: Static load capacity (N)	167500	229500	167500	229500	167500		
C100: Dynamic load capacity (N)	93400	127800	93400	127800	93400		
MOQ: Static cross moment capacity (Nm)	4621	6333	4621	6333	4621		
MOL: Static longitud. moment capacity (Nm)	2790	5161	2790	5161	2790		
MQ: Dyn. cross moment capacity (Nm)	2577	3527	2577	3527	2577		
ML: Dyn. longitud. moment capacity (Nm)	1556	2874	1556	2874	1556		
Gew.: Carriage weight (kg)	3.2	4.3	3.0	4.0	2.3		

Available options for MR W 45



MR S 55 Drawings

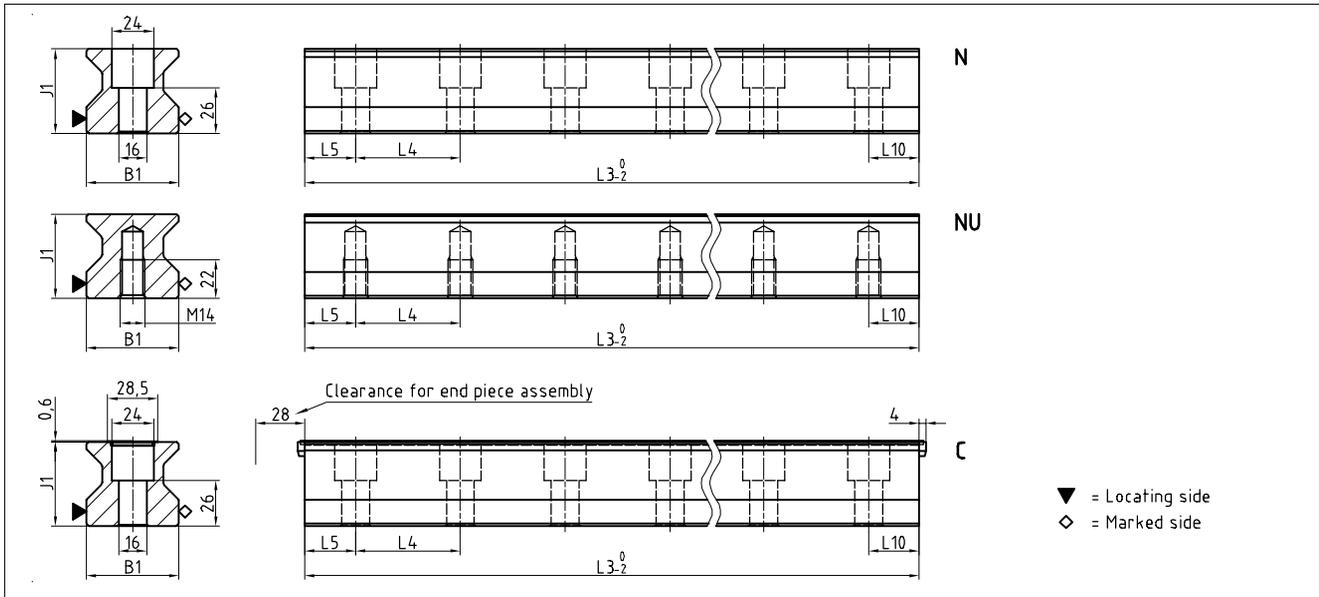

MR W 55 Drawings

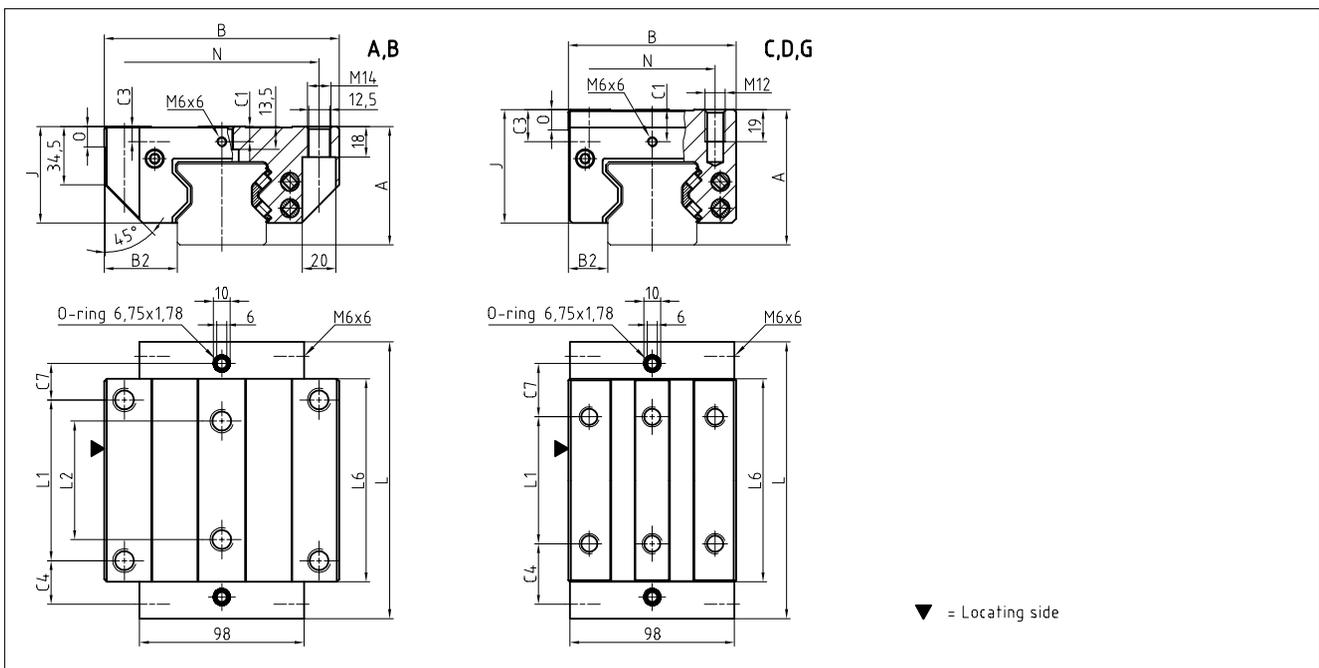

MR W 55 Rigidity diagram

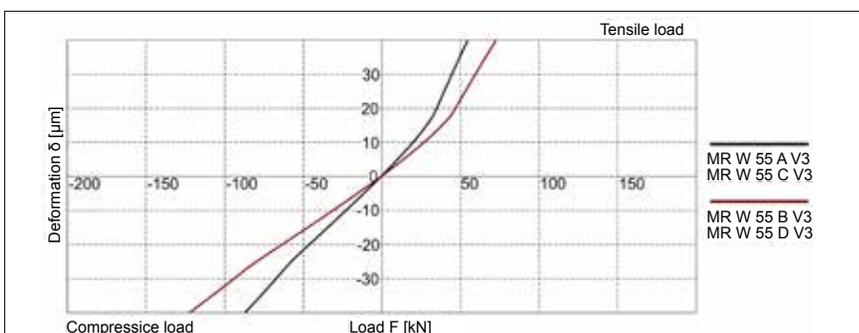

MR W 55 Load rating

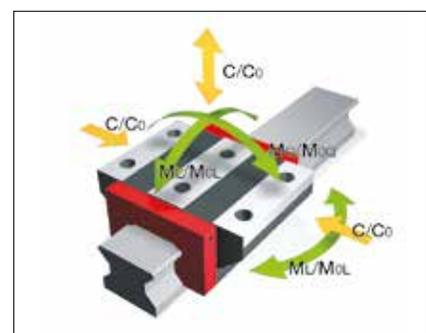

3.2 Technical data and options

MR Size 55

MR S 55 Dimensions



	MR S 55-N	MR S 55-NU	MR S 55-C			
B1: Rail width	53	53	53			
J1: Rail height	48	48	48			
L3: Rail length max.	6000	6000	6000			
L4: Spacing of fixing holes	60	60	60			
L5/L10: Position of first/last fixing hole	28.5	28.5	28.5			
Gew.: Rail weight, specific (kg/m)	15.2	16.6	14.9			

Available options for MR S 55



MR W 55 Dimensions and capacities



	MR W 55-A	MR W 55-B	MR W 55-C	MR W 55-D	MR W 55-G		
A: System height	70	70	80	80	70		
B: Carriage width	140	140	100	100	100		
B2: Distance between locating faces	43.5	43.5	23.5	23.5	23.5		
C1: Position of center front lube hole	9	9	19	19	9		
C3: Position of lateral lube hole	9	9	19	19	9		
C4: Position of lateral lube hole	25.75	46.75	35.75	46.75	46.75		
C7: Position of top lube hole	21.5	42.5	31.5	42.5	42.5		
J: Carriage height	57	57	67	67	57		
L: Carriage length	163.5	205.5	163.5	205.5	205.5		
L1: Exterior fixing hole spacing	95	95	75	95	95		
L2: Interior fixing hole spacing	70	70	-	-	-		
L6: Steel body length	120	162	120	162	162		
N: Lateral fixing hole spacing	116	116	75	75	75		
O: Reference face height	12	12	12	12	12		
Capacities and weights							
C0: Static load capacity (N)	237000	324000	237000	324000	324000		
C100: Dynamic load capacity (N)	131900	180500	131900	180500	180500		
MOQ: Static cross moment capacity (Nm)	7771	10624	7771	10624	10624		
MOL: Static longitud. moment capacity (Nm)	4738	8745	4738	8745	8745		
MQ: Dyn. cross moment capacity (Nm)	4325	5919	4325	5919	5919		
ML: Dyn. longitud. moment capacity (Nm)	2637	4872	2637	4872	4872		
Gew: Carriage weight (kg)	5.0	6.8	4.5	6.1	4.8		

Available options for MR W 55



MR S 65 Drawings

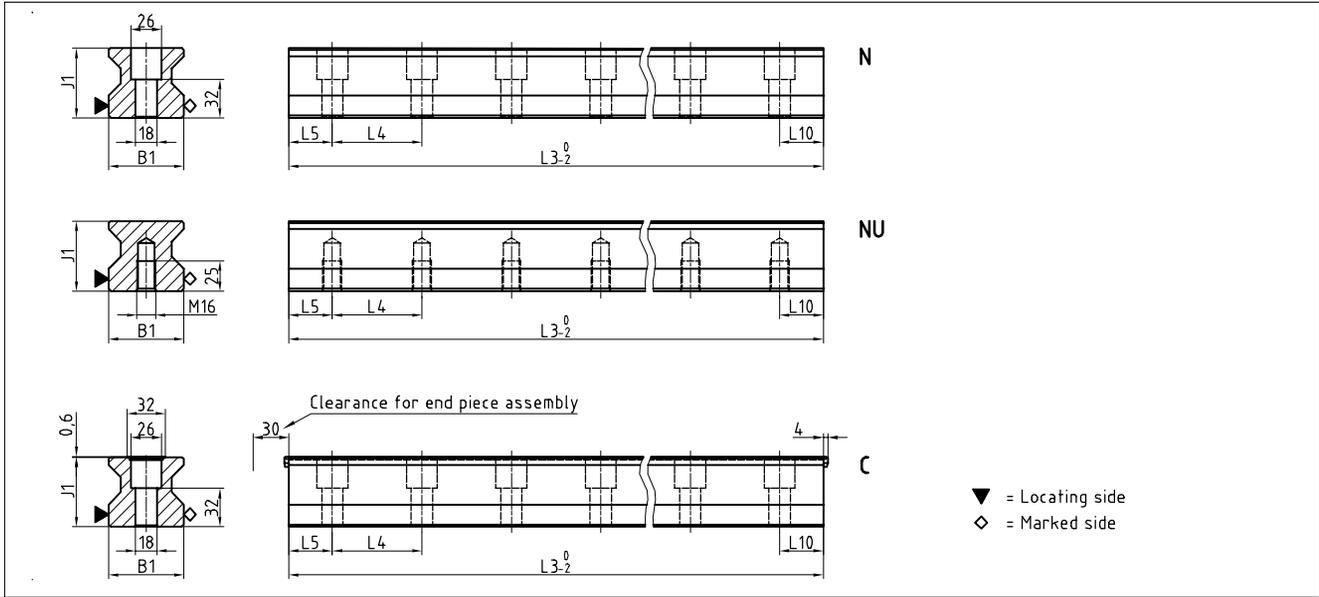

MR W 65 Drawings

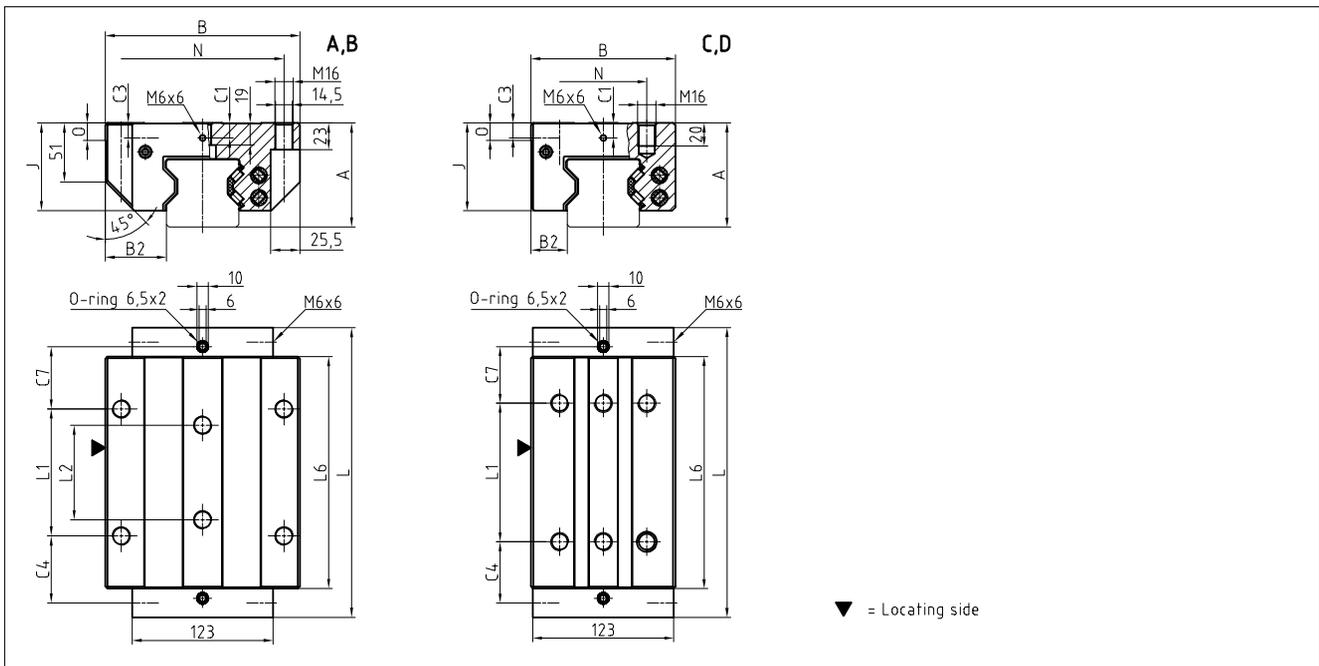

MR W 65 Rigidity diagram

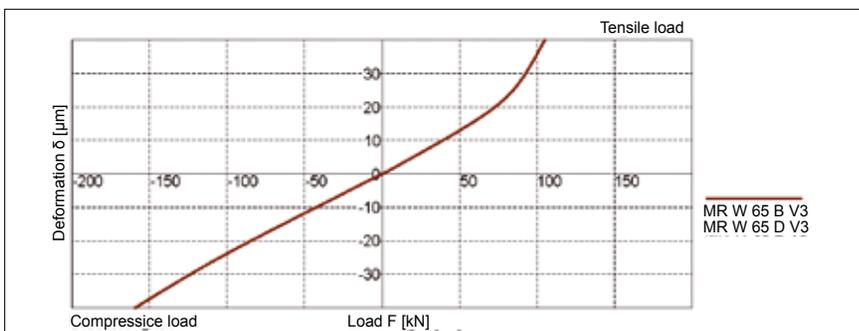

MR W 65 Load rating

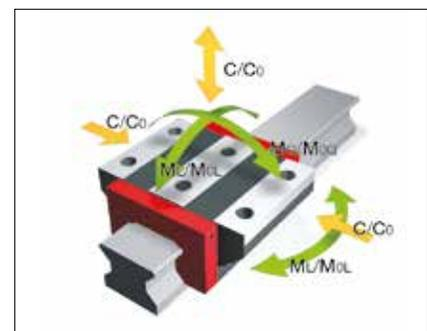

3.2 Technical data and options

MR Size 65

MR S 65 Dimensions



	MR S 65-N	MR S 65-NU	MR S 65-C			
B1: Rail width	63	63	63			
J1: Rail height	58	58	58			
L3: Rail length max.	6000	6000	6000			
L4: Spacing of fixing holes	75	75	75			
L5/L10: Position of first/last fixing hole	36	36	36			
Gew.: Rail weight, specific (kg/m)	22.8	24.5	22.5			

Available options for MR S 65



MR W 65 Dimensions and capacities



	MR W 65-A	MR W 65-B	MR W 65-C	MR W 65-D			
A: System height	90	90	90	90			
B: Carriage width	170	170	126	126			
B2: Distance between locating faces	53.5	53.5	31.5	31.5			
C1: Position of center front lube hole	13	13	13	13			
C3: Position of lateral lube hole	13	13	13	13			
C4: Position of lateral lube hole	31.75	58	51.75	53			
C7: Position of top lube hole	27.75	54	47.75	49			
J: Carriage height	76	76	76	76			
L: Carriage length	198.5	251	198.5	251			
L1: Exterior fixing hole spacing	110	110	70	120			
L2: Interior fixing hole spacing	82	82	-	-			
L6: Steel body length	148.5	201	148.5	201			
N: Lateral fixing hole spacing	142	142	76	76			
O: Reference face height	15	15	15	15			
Capacities and weights							
C0: Static load capacity (N)	419000	530000	419000	530000			
C100: Dynamic load capacity (N)	232000	295000	232000	295000			
MOQ: Static cross moment capacity (Nm)	16446	20912	16446	20912			
MOL: Static longitud. moment capacity (Nm)	10754	17930	10754	17930			
MQ: Dyn. cross moment capacity (Nm)	9154	11640	9154	11640			
ML: Dyn. longitud. moment capacity (Nm)	5954	9980	5954	9980			
Gew: Carriage weight (kg)	10.2	13.5	8.0	10.4			

Available options for MR W 65



MR S 100 Drawings

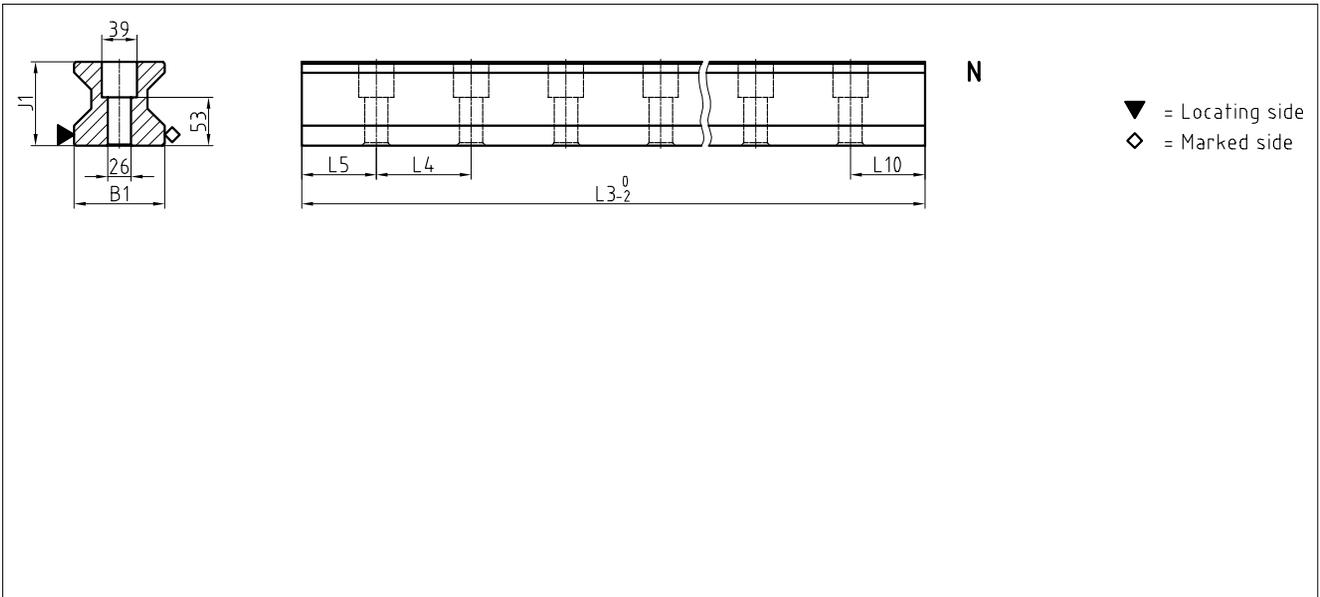

MR W 100 Drawings



MR W 100 Rigidity diagram

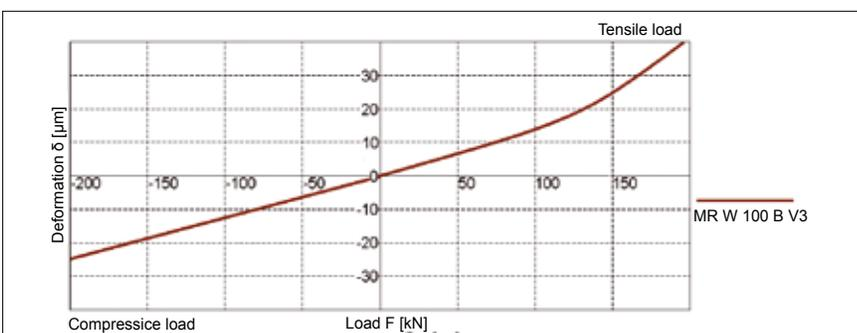

MR W 100 Load rating

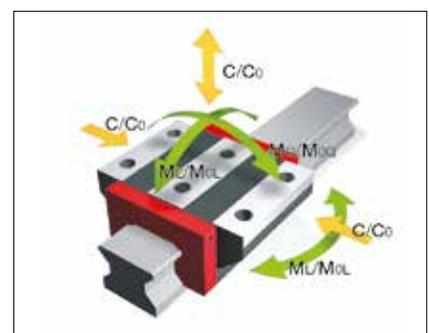

3.2 Technical data and options

MR Size 100

MR S 100 Dimensions



	MR S 100-N				
B1: Rail width	100				
J1: Rail height	92				
L3: Rail length max.	3000				
L4: Spacing of fixing holes	105				
L5/L10: Position of first/last fixing hole	51				
Gew.: Rail weight, specific (kg/m)	55.3				

Available options for MR S 100



MR W 100 Dimensions and capacities



	MR W 100-B				
A: System height	120				
B: Carriage width	250				
B2: Distance between locating faces	75				
C1: Position of center front lube hole	12.5				
C3: Position of lateral lube hole	12.5				
C4: Position of lateral lube hole	67				
C7: Position of top lube hole	67				
J: Carriage height	100				
L: Carriage length	400				
L1: Exterior fixing hole spacing	200				
L2: Interior fixing hole spacing	-				
L6: Steel body length	308				
N: Lateral fixing hole spacing	220				
O: Reference face height	20				
Capacities and weights					
C0: Static load capacity (N)	1470000				
C100: Dynamic load capacity (N)	605000				
MOQ: Static cross moment capacity (Nm)	91471				
MOL: Static longitud. moment capacity (Nm)	39432				
MQ: Dyn. cross moment capacity (Nm)	37646				
ML: Dyn. longitud. moment capacity (Nm)	16229				
Gew: Carriage weight (kg)	40.0				

Available options for MR W 100

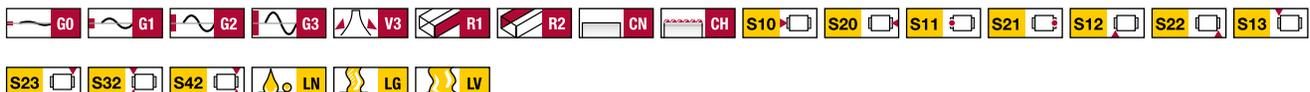

MR Rails accessories overview

Accessories	MR S 25	MR S 35	MR S 45	MR S 55	MR S 65	MR S 100	
Plugs:							
Plastic plugs	MRK 25	MRK 35	MRK 45	MRK 55	MRK 65	-	
Brass plugs	MRS 25	MRS 35	MRS 45	MRS 55	MRS 65	MRS 100	
Steel plugs	MRZ 25	MRZ 35	MRZ 45	MRZ 55	MRZ 65	MRZ 100	
Cover strips:							
Cover strip (spare part)	MAC 25	MAC 35	MAC 45	MAC 55	MAC 65	-	
Securing band for cover strip (spare part)	BSC 25-MAC	BSC 35-MAC	BSC 45-MAC	BSC 55-MAC	BSC 65-MAC	-	
End piece for cover strip (spare part)	EST 25-MAC	EST 35-MAC	EST 45-MAC	EST 55-MAC	EST 65-MAC	-	
Assembly tools:							
Installation tool for steel plugs	MWH 25	MWH 35	MWH 45	MWH 55	MWH 65	MWH 100	
Hydraulic cylinder for MWH	MZH	MZH	MZH	MZH	MZH	MZH	
Installation tool for cover strip	MWC 25	MWC 35	MWC 45	MWC 55	MWC 65	-	

MR Carriages accessories overview

Accessories	MR W 25	MR W 35	MR W 45	MR W 55	MR W 65	MR W 100	
Additional wipers:							
Additional wipers NBR	ZCN 25	ZCN 35	ZCN 45	ZCN 55	ZCN 65	ZCN 100	
Additional wipers Viton	ZCV 25	ZCV 35	ZCV 45	ZCV 55	ZCV 65	ZCV 100	
Metal wiper	ASM 25	ASM 35	ASM 45	ASM 55	ASM 65	ASM 100	
Bellows:							
Bellows	FBM 25	FBM 35	FBM 45	FBM 55	FBM 65	-	
Adapter plate for bellows (spare part)	ZPL 25	ZPL 35	ZPL 45	ZPL 55	ZPL 65	-	
End plate for bellows (spare part)	EPL 25	EPL 35	EPL 45	EPL 55	EPL 65	-	
Assembly rails:							
Assembly rail	MRM 25	MRM 35	MRM 45	MRM 55	MRM 65	MRM 100	
Lubrication plates:							
Lubrication plate	SPL 25-MR	SPL 35-MR	SPL 45-MR	SPL 55-MR	SPL 65-MR	-	
Front plates:							
Front plate (spare part)	STP 25-EK	STP 35-EK	STP 45-EK	STP 55-EK	STP 65-EK	STP 100-EK	
Lube nipples:							
Hydraulic-type grease nipple straight	SN 6	SN 6	SN 6	SN 6	SN 6	SN 6	
Hydraulic-type grease nipple 45°	SN 6-45	SN 6-45	SN 6-45	SN 6-45	SN 6-45	SN 6-45	
Hydraulic-type grease nipple 90°	SN 6-90	SN 6-90	SN 6-90	SN 6-90	SN 6-90	SN 6-90	
Flush type grease nipple M6	SN 6-T	SN 6-T	SN 6-T	SN 6-T	SN 6-T	SN 6-T	
Grease gun for SN 3-T und SN 6-T	SFP-T3	SFP-T3	SFP-T3	SFP-T3	SFP-T3	SFP-T3	
Lube adapters:							
Lubrication adapter M8 round-head	SA 6-RD-M8	SA 6-RD-M8	SA 6-RD-M8	SA 6-RD-M8	SA 6-RD-M8	SA 6-RD-M8	
Lubrication adapter M8 hexagon head	-	SA 6-6KT-M8	SA 6-6KT-M8	SA 6-6KT-M8	SA 6-6KT-M8	SA 6-6KT-M8	
Lubrication adapter G1/8 hexagon head	-	SA 6-6KT-G1/8	SA 6-6KT-G1/8	SA 6-6KT-G1/8	SA 6-6KT-G1/8	SA 6-6KT-G1/8	
Swivel screw connection for pipe d=4 mm	SV 6-D4	SV 6-D4	SV 6-D4	SV 6-D4	SV 6-D4	SV 6-D4	
Swivel screw connection M6	SV 6-M6	SV 6-M6	SV 6-M6	SV 6-M6	SV 6-M6	SV 6-M6	
Swivel screw connection M6 long	SV 6-M6-L	SV 6-M6-L	SV 6-M6-L	SV 6-M6-L	SV 6-M6-L	SV 6-M6-L	
Swivel screw connection M8	SV 6-M8	SV 6-M8	SV 6-M8	SV 6-M8	SV 6-M8	SV 6-M8	
Swivel screw connection M8 long	SV 6-M8-L	SV 6-M8-L	SV 6-M8-L	SV 6-M8-L	SV 6-M8-L	SV 6-M8-L	

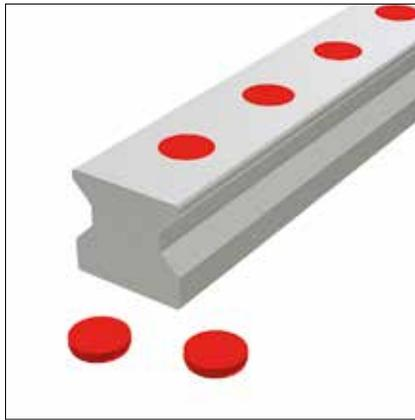

Plastic plugs

MRK plastic plugs are used as a low-cost method of closing off the rail attachment holes. They can be fitted manually with fairly simple tools. Plastic plugs are recommended for use with protected axes or in environments with low levels of contamination, e.g. handling.

Quantity supplied: Pack of 25 pcs.

Order code: **MRK xx**

xx = Size, sample order: 6 x MRK 65

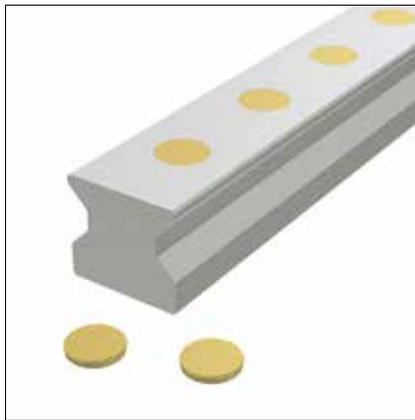

Brass plugs

Brass plugs are used in applications with increased contamination or external temperature influences, e.g., in the case of chip impact or whenever a smooth and gap-free rail surface is required.

A hydraulic MWH fitting tool is recommended for correct installation.

Order code: **MRS xx**

xx = Size, sample order: 48 x MRS 65



Steel plugs

Made of stainless steel, the two-part steel plugs are suitable for applications with greater demands on the mechanical stability of rail surfaces, e.g. when mechanical loads are higher or in open chip spaces. They combine the advantages of simple and very precise installation and a high degree of mechanical stability.

Function:

The clamping ring lies loosely on the screw head in the hole in the rail. When the slightly conical plug is pressed in, the ring is expanded to establish a positive frictional connection between the plug and the hole in the rail.

When fitted, the plug is flush with the rail surface where it ensures that the wipers operate to the optimum degree and have an optimum service life.

A hydraulic MWH fitting tool is necessary for correct installation.

Order code: **MRZ xx**

xx = Size, sample order: 48 x MRZ 65

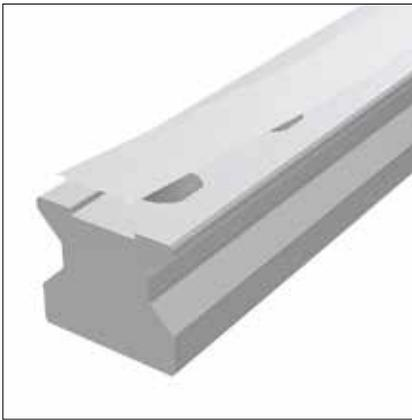

Cover strip (spare part)

A SCHNEEBERGER MAC cover strip combines technical functionality with simple handling and neat appearance. Made of stainless spring steel, the strip is suitable for demanding applications with increased contamination or external temperature influences.

- It provides the following advantages:
- Reliable fixing along the length as it is clipped into a special groove
- Additional fixing of the ends of the strips using locking parts (EST xx-MAC)
- Very robust thanks to the substantial thickness of the material
- The strip free top surface of the rail can be used to support covers
- Can be fitted and removed several times
- Protection of the wipers during installation as the rail holes are recessed in the groove
- Available in any length up to 30m

When ordering guide rails with cover strips, they are included in the scope of supply.

Order code: **MAC xx-yy**

xx = Size, yy = Rail length in mm, sample order: 1 x MAC 65-4320

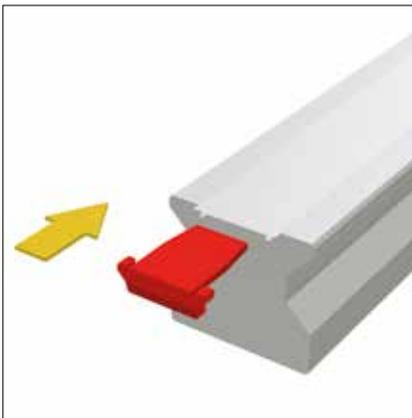

End piece for cover strip (spare part)

EST end pieces are used to close the ends of MAC cover strips. To do this, these plastic parts are inserted on both ends of the rail into the gap under the cover strip. Their special design prevents the ends of the cover strip from lifting and reduces the danger of injury on the sharp edges of the cover strip.

Order code: **EST xx-MAC**

xx = Size, sample order: 2 x EST 65-MAC



Securing band for cover strip (spare part)

The BSC securing band for cover strips is used to secure the ends when mechanical loads are high. To do this, the protruding band ends are cut off at right angles and burr-free, and a fastening thread is fitted to the front face of the rail.

Securing bands are used in applications with high vibration levels, with rails in open chip spaces, with rail lengths of less than 600 mm or for vertical fitting and the subsequent risk that EST endpieces could fall out.

The securing band also covers the ends of the cover strips and reduces the risk of injury on the sharp corners of the ends.

Order code: **BSC xx-MAC**

xx = Size, order example: 2 x BSC 65-MAC

3.3 Accessories

MR Rails accessory details



Installation tool for cover strip

A MWC fitting tool is used to simplify the fitting of an MAC cover strip. At the same time, it ensures that the cover strip sits securely in the rail groove without any gaps.

Order code: **MWC xx**

xx = Size, sample order: 1 x MWC 35



Installation tool for steel plugs

An MWH hydraulic cylinder is a single-action block cylinder used to create the required insertion force. A standard hydraulic unit that provides the pressure required for the insertion process is connected to the 1/4" threaded connection. The hydraulic cylinder fits all sizes of MWH fitting tool and must be ordered separately.

Order code: **MWH**

Sample order: 1 x MWH

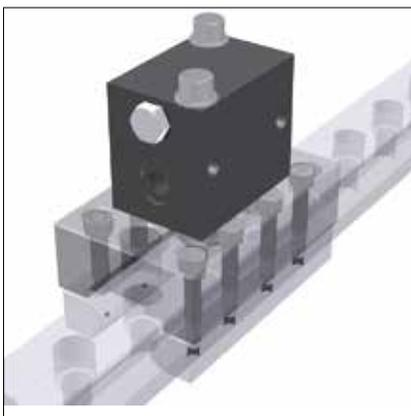

Hydraulic cylinder for MWH

An MZH hydraulic cylinder is a single-action block cylinder used to create the required insertion force. A standard hydraulic unit that provides the pressure required for the insertion process is connected to the 1/4" threaded connection. The hydraulic cylinder fits all sizes of MWH fitting tool and must be ordered separately.

Order code: **MZH**

Sample order: 1 x MZH



Additional wiper NBR

ZCN nitrile wipers provide additional protection of the carriages in heavily contaminated environments. Thanks to their flexibility, they can be fitted directly over the rail cross section. ZCN wipers can also be used in combination with ASM metal wipers.

Order code: **ZCN xx**

xx = Size, sample order: 2 x ZCN 65



Additional wiper Viton

Like ZCN wipers, ZCV additional wipers provide extra protection of the carriages in heavily contaminated environments. Made of Viton® (fluoroelastomer), they are suitable for use with aggressive coolants.

As their flexibility allows them to be pushed over the rail cross section, retrofitting is possible without the need to remove the carriage from the rail. ZCV wipers can also be used in combination with ASM metal wipers.

Order code: **ZCV xx**

xx = Size, sample order: 2 x ZCV 65

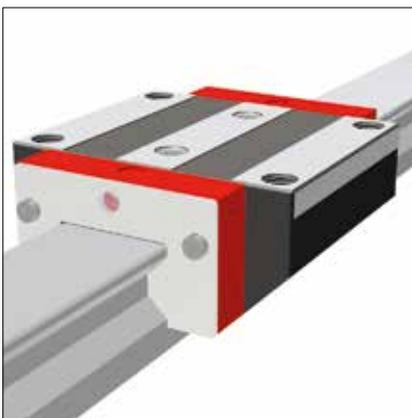

Metal wiper

Made of stainless steel, ASM metal wipers are used to protect the sealing lips of carriages and additional wipers against hot metal chips. Large and loose dirt particles are pushed away and cannot get jammed due to the controlled dimension of the gap with the rail. Specially adapted types are available for rails using AMS measuring systems. Metal wipers are ideally used in combination with ZCN/ZCV additional wipers.

Order code: **ASM xx**

xx= Size, sample order: 1 x ASM 65



Bellows

Standard bellows are available for MONORAIL sizes MR 25 – MR 65, the purpose of which is to provide additional protection against dust and water splashes. The bellows are made of synthetic fabric coated on both sides with plastic. The bellows cover the entire length of the rail and their cross section matches the faceplate of the carriage. The external dimensions of the carriage are thus not exceeded by the bellows. Installation is simple and takes little time. A ZPL adapter plate is required to attach the bellows to the carriage. The adapter plate is screwed to the front plate of the carriage using a central screw. An EPL end plate is screwed to the end face of the rail. The bellows are fastened by two rivets to both the adapter plate and the front plate. Retrofitting can only be realised with induction hardened rails as the rail ends have to be drilled for the attachment of the EPL end plates. When ordering a guideway with bellows, the fixing holes for the end plates are arranged in the rails.

Order code: **FBM xx-yy**

xx = Size, yy = Number of folds, sample order: 1 x FBM 65-137

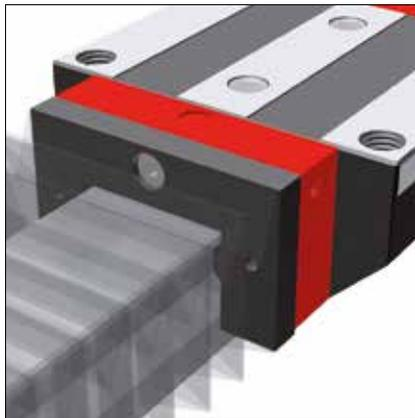

Adapter plate for bellows (spare part)

The adapter plate is used to attach the bellows to the carriage and is included with every order for bellows. It is made of black anodized aluminium. On an MR 25 size, the adapter plate is also used for a lateral lubrication connection.

The outer contour of the adapter plate corresponds to that of the carriage front plate, the bellows and the end plate. The central fastening screw is included in the scope of supply.

Order code: **ZPL xx**

XX = Size, sample order: 2 x ZPL 65

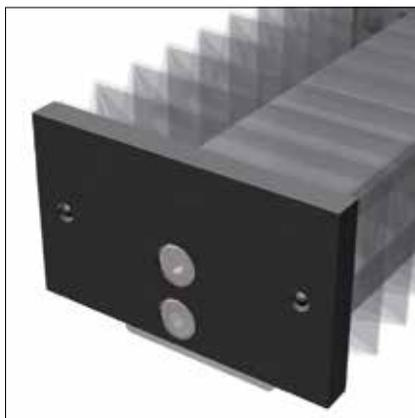

End plate for bellows (spare part)

Made of black anodized aluminium, the end plate is used to attach the bellows to the end of the rail. It is included with every order for a set of bellows.

The attaching holes must be drilled in the rail if the bellows are to be retrofitted. For this reason, we recommend the use of induction-hardened rails for retrofits.

The external dimensions of the end plate correspond to that of the carriage front plate, the bellows and the adapter plate. Both fastening screws are supplied with the end plate.

Order code: **EPL xx**

xx = Size, sample order: 2 x EPL 65



Assembly rail

The assembly rail is required when a carriage has to be removed from the rail and then reinstalled during the installation of the MONORAIL.

It is advisable to leave the assembly rail in the carriage to protect the rollers against contamination.

If necessary, the two internal carriage attaching screws can be fitted and tightened through the two holes in the assembly rail.

Order code: **MRM xx**

xx = Size, sample order: 1 x MRM 65



Lubrication plate

An SPL lubrication plate is used wherever long lubrication intervals are required. Thanks to its integral oil reservoir, the rolling elements are supplied with an automatic and uniform supply of lubrication over an extended period.

It is ideally used in dry and clean environments as in handling technology or on the ancillary axes of machine tools.

The advantages are:

- Assured supply of lubrication in any installation position
- Long lubrication intervals of up to 5,000 km or 12 months according to use
- Refill apertures closed with screws
- Reduced outlay on lubrication and accessories
- Low environmental impact thanks to minimum consumption of lubricant
- Wipers have a long service life as oil is also supplied to the top surface of the rail

For maximum travel distances without re-lubrication, the lubrication plates are always used in pairs and the carriages are given an additional filling of grease.

The lubrication plates have the same dimensions as the carriage front plates and are installed in front of these. Retrofitting is possible.

Additional ZBN-U/ZBV-U wipers must be provided in applications in which particles of dirt can come into contact with the guideways.

Order code: **SPL xx-MR**

xx = Size, sample order: 2 x SPL 65-MR

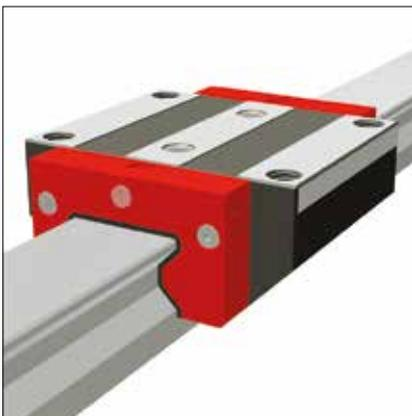

Front plate (spare part)

The red front plates have two essential functions:

- To supply lubricant
- To seal a MONORAIL carriage

Lubrication can be supplied to the carriages through several integrated lubrication connection ports. Lubrication channels inside the front plate directly distribute the lubrication to the rollers.

Integral twin-lip cross wipers seal the carriage at the ends and prevent the ingress of dirt and the loss of lubrication. Because the cross wipers are subject to wear, the front plates have to be examined regularly and if necessary replaced.

Order code: **STP xx-EK**

xx = Size, sample order: 1 x STP 65-EK

3.4 Order key

Individual guide rails and carriages are ordered in accordance with the order codes described below.

Q.v. chapter 2.1 and chapter 3.3 for the order key for accessories.

Separate order codes are used in each case for rails, carriages and accessories. This also applies to different versions of rails and carriages.

All guide components are supplied individually as standard, i.e. unassembled.

If required, SCHNEEBERGER can also supply rails and carriages assembled incl. accessories as complete systems. Please note the ordering instructions in chapter 2.4 if this applies.

Order code for MR Rails

	2x	MR S	35	-N	-G1	-KC	-R1	-918	-19	-19	-CN
Quantity											
Rail											
Size											
Type											
Accuracy											
Straightness											
Reference side											
Rail length L3											
Position of first fixing hole L5											
Position of last fixing hole L10											
Coating											

NB

Q.v. chapter 3.1 to 3.3 for an overview of types, details of shapes, available options and accessories.

Q.v. chapter 2 for a description of the options.

If possible, standard lengths are preferred for L3 rail length.

These are calculated with the table values in chapter 3.2 using the following formula: $L3 = n \times L4 + L5 + L10 \leq L3_{max}$.

Order code for MR Carriages

	4x	MR W	35	-A	-G1	-V3	-R1	-CN	-S10	-LN
Quantity										
Carriage										
Size										
Type										
Accuracy										
Preload										
Reference side										
Coating										
Lube connection										
Lubrication as delivered condition										

NB

Q.v. chapter 3.1 to 3.3 for an overview of types, details of shapes, available options and accessories.

Q.v. chapter 2 for a description of the options.

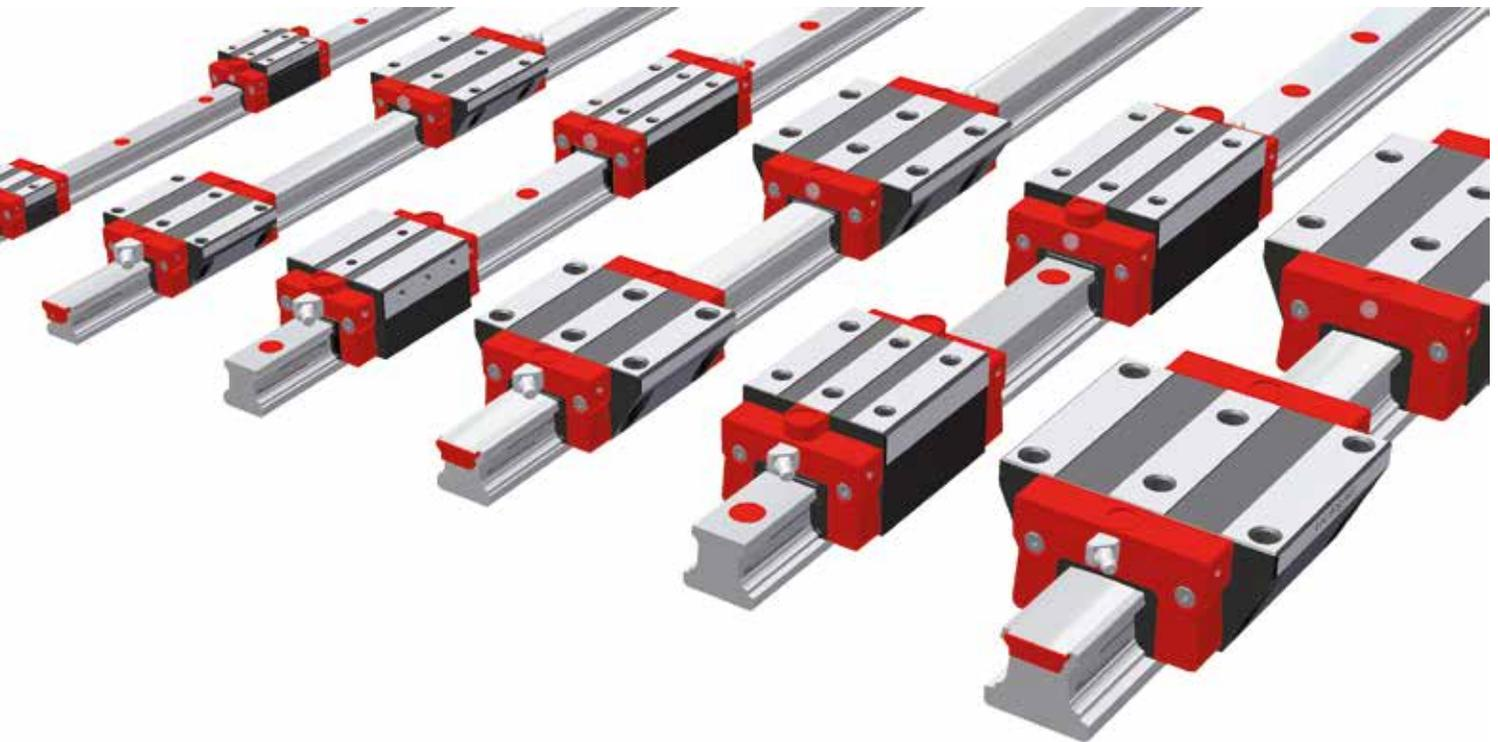

Very good dynamic characteristics and superb economy are the distinguishing features of the MONORAIL BM ball guideway. Thanks to the small number of transitions in the ball tracks, this novel design with its low number of optimally designed components provides outstanding running characteristics, which are distinguished by smooth running, low pulsation, reduced friction values and high travelling speeds.

The trapezoidal rail section guideway results in a highly rigid guideway and also substantially reduces the amount of maintenance required since parts subject to wear can be replaced without the need to dismantle the guideway. Complete sealing of the carriages is a guarantee of unparalleled reliability matched by a long service life. This robust and versatile guideway thus ideally complements the MONORAIL MR roller guideway.

Features of System MONORAIL BM



Details see chapter 1

4.1 Overview of types, sizes and available options

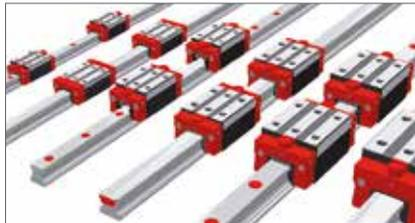

Product overview BM Rails	Page 64
Product overview BM Carriages	Page 65

4.2 Technical data and options

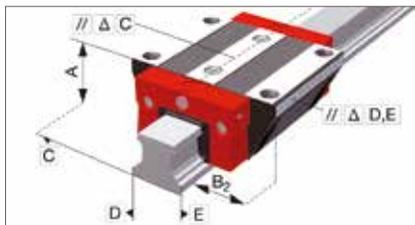

BM Size 15	Page 66
BM Size 20	Page 68
BM Size 25	Page 70
BM Size 30	Page 72
BM Size 35	Page 74
BM Size 45	Page 76

4.3 Accessories MONORAIL BM



Accessories overview	Page 78
BM Rails accessory details	Page 79
BM Carriages accessory details	Page 81

4.4 Order key



Order code for BM Rails	Page 84
Order code for BM Carriages	Page 84

Product overview BM Rails



	N standard	ND with tapped holes at the bottom	NXD standard, half pitch, through hardened	NU with tapped holes at the bottom	C for cover strip	CD for cover strip, through hardened
Buildsizes / Rail build forms						
Size 15	BM S 15-N	BM S 15-ND	BM S 15-NXD			BM S 15-CD
Size 20	BM S 20-N			BM S 20-NU	BM S 20-C	
Size 25	BM S 25-N			BM S 25-NU	BM S 25-C	
Size 30	BM S 30-N			BM S 30-NU	BM S 30-C	
Size 35	BM S 35-N			BM S 35-NU	BM S 35-C	
Size 45	BM S 45-N			BM S 45-NU	BM S 45-C	
Features						
Screwable from above	●	●	●		●	●
Screwable from below				●		
Small assembly effort				●	●	●
Highly accurate mounting without lateral locating surface			●			
Great single-part system length	●			●	●	
For the support of metal covers		●	●			

Available options for BM Rails

Details see chapter 2

Accuracy

- G0 Highly accurate
- G1 Very accurate
- G2 Accurate
- G3 Standard

Straightness

- KC Standard

Reference side

- R1 Ref. at bottom
- R2 Ref. on top

Coating

- CN None
- CH Hard chromium

Available accessories for MR Rails

Details see chapter 4.3

Plugs

Cover strips

Assembly tools

4.1 Overview of types, sizes and available options

BM Carriages

Product overview BM Carriages

							
	A standard	B standard, long	C compact, high	D compact, high, long	E compact, high, for lateral fixation	F compact	G compact, long
Buildsizes / Carriage build forms							
Size 15	BM W 15-A		BM W 15-C			BM W 15-F	
Size 20	BM W 20-A	BM W 20-B	BM W 20-C	BM W 20-D			
Size 25	BM W 25-A	BM W 25-B	BM W 25-C	BM W 25-D	BM W 25-E	BM W 25-F	BM W 25-G
Size 30	BM W 30-A	BM W 30-B	BM W 30-C	BM W 30-D	BM W 30-E	BM W 30-F	BM W 30-G
Size 35	BM W 35-A	BM W 35-B	BM W 35-C	BM W 35-D	BM W 35-E	BM W 35-F	BM W 35-G
Size 45	BM W 45-A	BM W 45-B	BM W 45-C	BM W 45-D		BM W 45-F	BM W 45-G
Features							
Screwable from above	•	•	•	•		•	•
Screwable from below	•	•					
Screwable from the side					•		
For high loads and moments		•		•			•
For medium loads and moments	•		•		•	•	
For limited installation space						•	•

Available options for BM Carriages

Details see chapter 2

Accuracy

-  **G0** Highly accurate
-  **G1** Very accurate
-  **G2** Accurate
-  **G3** Standard

Preload

-  **V0** very low
-  **V1** Low
-  **V2** Mittel
-  **V3** High

Reference side

-  **R1** Ref. at bottom
-  **R2** Ref. on top

Coating

-  **CN** None
-  **CH** Hard chromium

Lube connections

-  **S10** Left center
-  **S20** Right center
-  **S11** Top left
-  **S21** Top right
-  **S12** Lower left side
-  **S22** Lower right side

-  **S13** Upper left side
-  **S23** Upper right side
-  **S32** Left side
-  **S42** Right side

Lubrication

-  **LN** Oil protect
-  **LG** Grease protect
-  **LV** Full greasing

Available accessories for MR Carriages

Details see chapter 4.3 and 2.1

Additional wipers
Front plates

Bellows
Lube nipples

Assembly rails
Lube adapters

Lubrication plates

BM S 15 Drawings

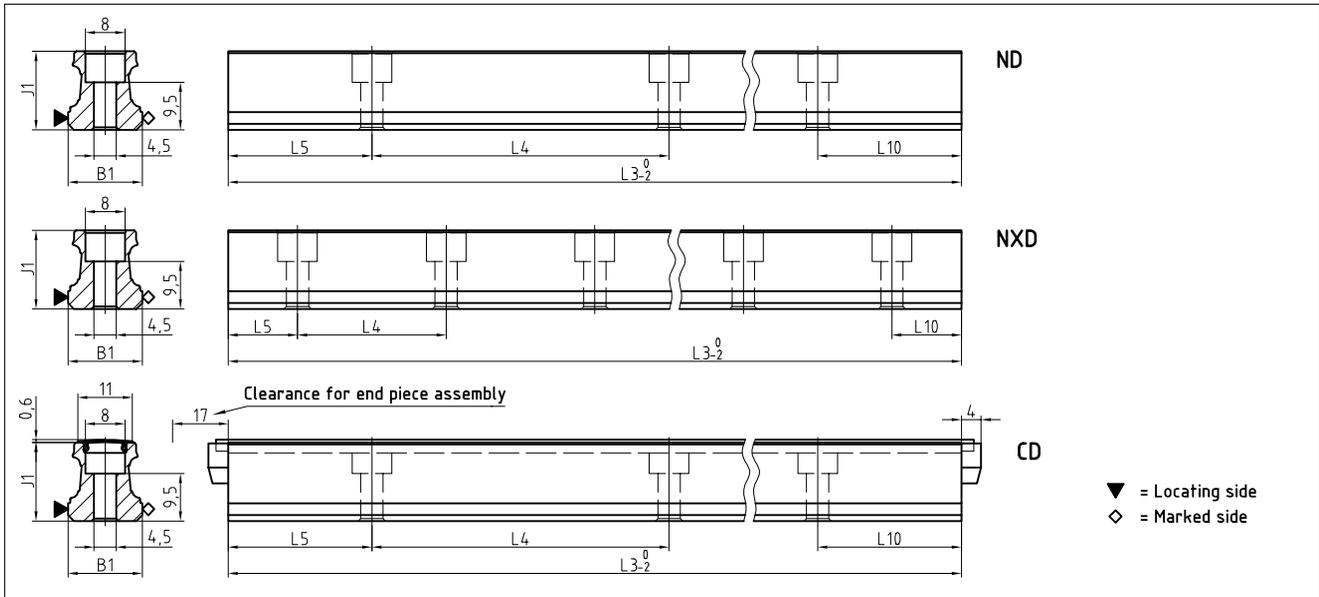

BM W 15 Drawings

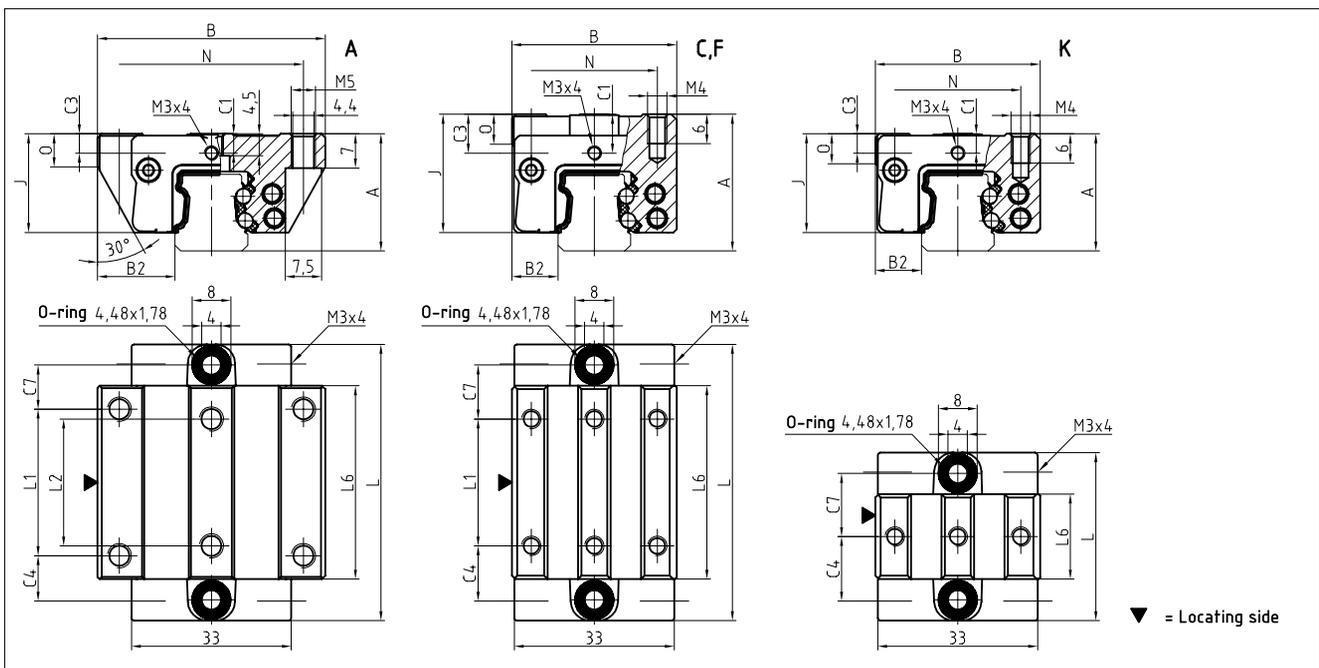

BM W 15 Rigidity diagram

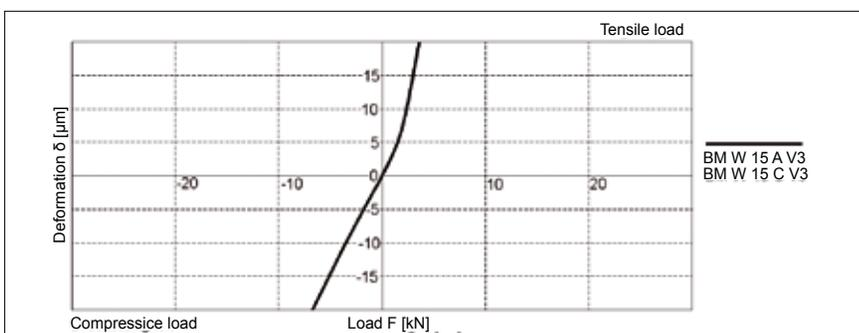

BM W 15 Load rating

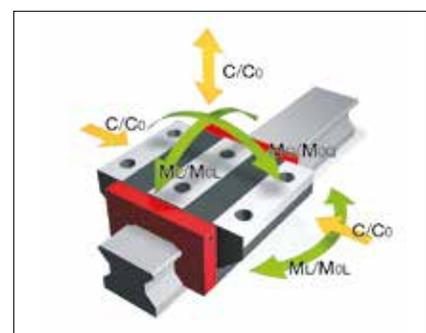

4.2 Technical data and options

BM Size 15

BM S 15 Dimensions



	BM S 15-ND	BM S 15-NXD	BM S 15-CD			
B1: Rail width	15	15	15			
J1: Rail height	15.7	15.7	15.7			
L3: Rail length max.	1500	1500	1500			
L4: Spacing of fixing holes	60	30	60			
L5/L10: Position of first/last fixing hole	28.5	13.5	28.5			
Gew.: Rail weight, specific (kg/m)	1.4	1.4	1.3			

Available options for BM S 15



BM W 15 Dimensions and capacities



	BM W 15-A	BM W 15-C	BM W 15-F	BM W 15-K			
A: System height	24	28	24	24			
B: Carriage width	47	34	34	34			
B2: Distance between locating faces	16	9.5	9.5	9.5			
C1: Position of center front lube hole	4	8	4	4			
C3: Position of lateral lube hole	4	8	4	4			
C4: Position of lateral lube hole	9.3	11.3	11.3	14.8			
C7: Position of top lube hole	9.05	11.05	11.05	14.55			
J: Carriage height	20.2	24.2	20.2	20.2			
L: Carriage length	56.6	56.6	56.6	37.6			
L1: Exterior fixing hole spacing	30	26	26	-			
L2: Interior fixing hole spacing	26	-	-	-			
L6: Steel body length	39.6	39.6	39.6	20.6			
N: Lateral fixing hole spacing	38	26	26	26			
O: Reference face height	7	6	6	6			
Capacities and weights							
C0: Static load capacity (N)	19600	19600	19600	8500			
C100: Dynamic load capacity (N)	9000	9000	9000	5200			
MOQ: Static cross moment capacity (Nm)	181	181	181	78			
MOL: Static longitud. moment capacity (Nm)	146	146	146	30			
MQ: Dyn. cross moment capacity (Nm)	83	83	83	48			
ML: Dyn. longitud. moment capacity (Nm)	67	67	67	18			
Gew: Carriage weight (kg)	0.2	0.3	0.2	0.2			

Available options for BM W 15



4.2 Technical data and options

BM Size 20

BM S 20 Dimensions



	BM S 20-N	BM S 20-NU	BM S 20-C			
B1: Rail width	20	20	20			
J1: Rail height	19	19	19			
L3: Rail length max.	3000	3000	3000			
L4: Spacing of fixing holes	60	60	60			
L5/L10: Position of first/last fixing hole	28.5	28.5	28.5			
Gew.: Rail weight, specific (kg/m)	2.2	2.3	2.1			

Available options for BM S 20



BM W 20 Dimensions and capacities



	BM W 20-A	BM W 20-B	BM W 20-C	BM W 20-D	BM W 20-K		
A: System height	30	30	30	30	28		
B: Carriage width	63	63	44	44	44		
B2: Distance between locating faces	21.5	21.5	12	12	12		
C1: Position of center front lube hole	5.2	5.2	5.2	5.2	4.2		
C3: Position of lateral lube hole	5.2	5.2	5.2	5.2	4.2		
C4: Position of lateral lube hole	10.75	18.75	12.75	13.75	18.85		
C7: Position of top lube hole	10.25	18.25	12.25	13.25	18.35		
J: Carriage height	25.5	25.5	25.5	25.5	23.5		
L: Carriage length	71.5	87.5	71.5	87.5	47.7		
L1: Exterior fixing hole spacing	40	40	36	50	-		
L2: Interior fixing hole spacing	35	35	-	-	-		
L6: Steel body length	49.5	65.5	49.5	65.5	25.7		
N: Lateral fixing hole spacing	53	53	32	32	32		
O: Reference face height	8.5	8.5	6.5	6.5	4		
Capacities and weights							
C0: Static load capacity (N)	31400	41100	31400	41100	13100		
C100: Dynamic load capacity (N)	14400	17400	14400	17400	8400		
MOQ: Static cross moment capacity (Nm)	373	490	373	490	150		
MOL: Static longitud. moment capacity (Nm)	292	495	292	495	58		
MQ: Dyn. cross moment capacity (Nm)	171	206	171	206	99		
ML: Dyn. longitud. moment capacity (Nm)	134	208	134	208	37		
Gew: Carriage weight (kg)	0.5	0.6	0.4	0.5	0.3		

Available options for BM W 20



BM S 25 Drawings

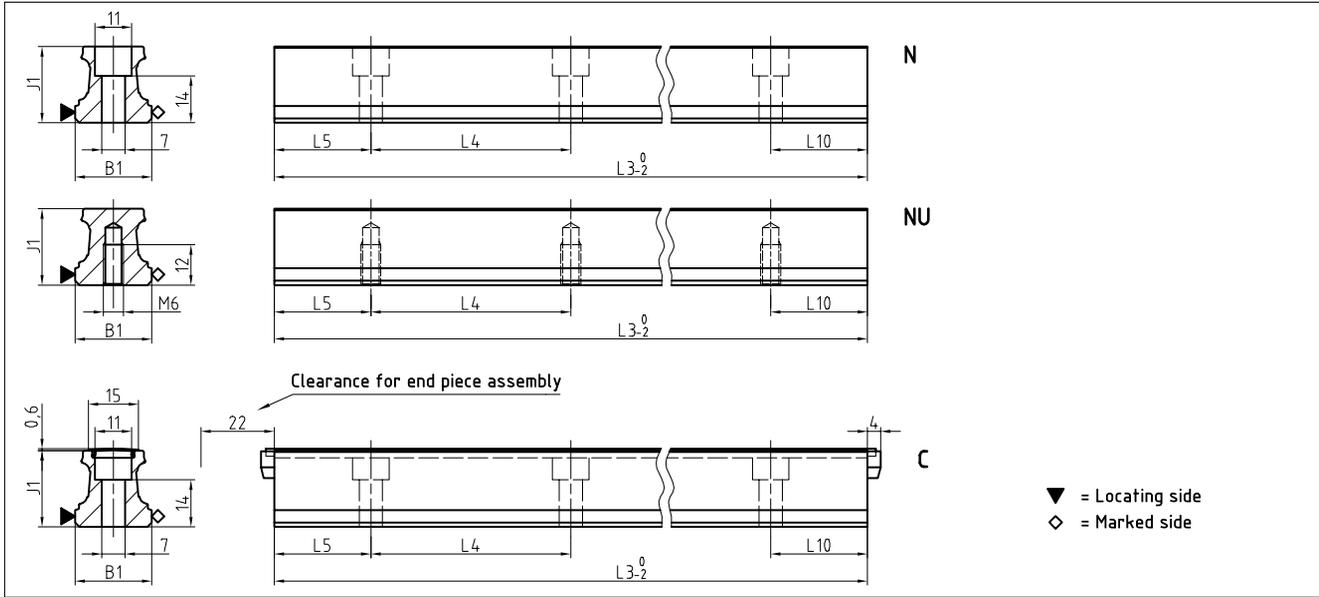

BM W 25 Drawings

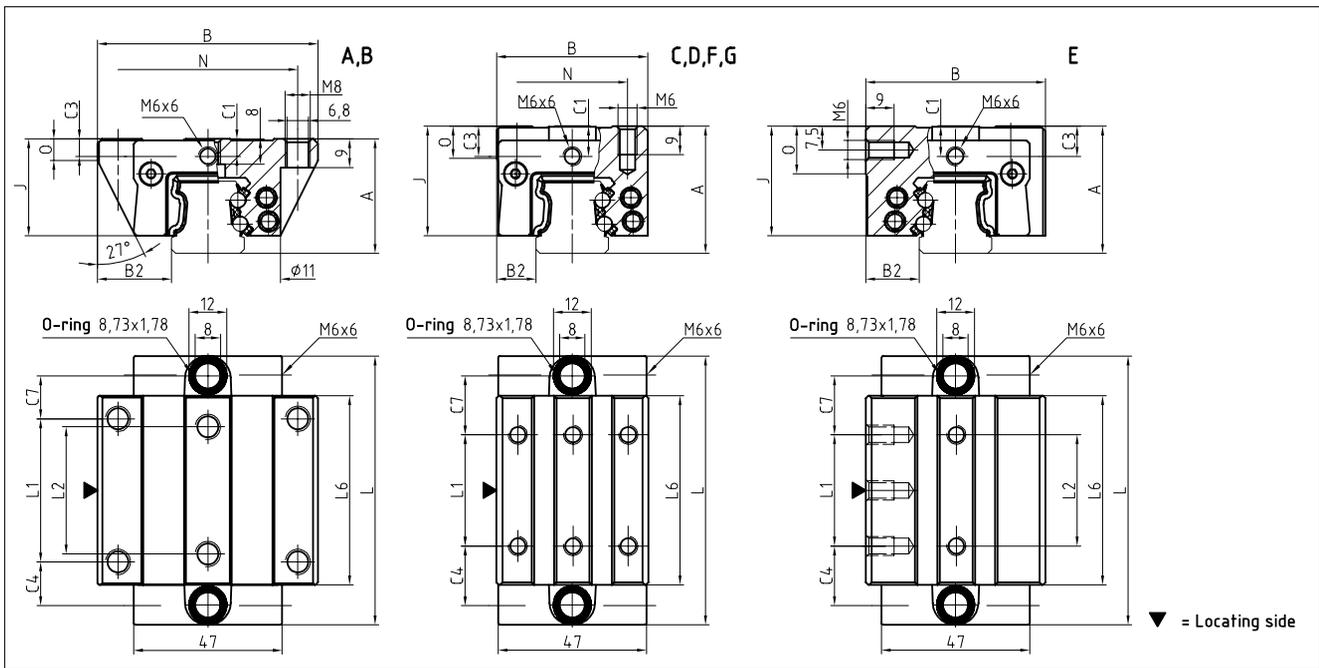

BM W 25 Rigidity diagram

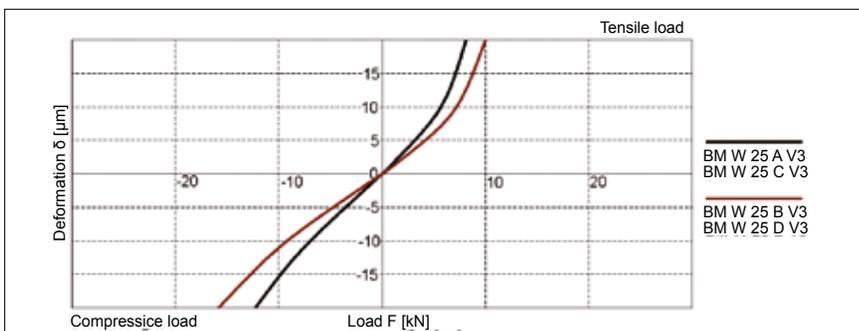

BM W 25 Load rating

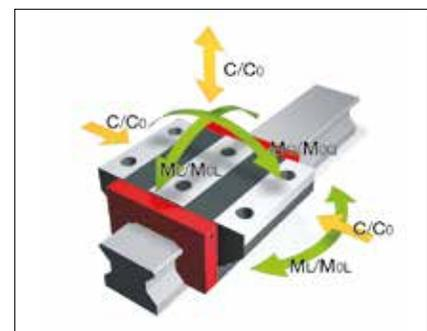

4.2 Technical data and options

BM Size 25

BM S 25 Dimensions



	BM S 25-N	BM S 25-NU	BM S 25-C			
B1: Rail width	23	23	23			
J1: Rail height	22.7	22.7	22.7			
L3: Rail length max.	6000	6000	3000			
L4: Spacing of fixing holes	60	60	60			
L5/L10: Position of first/last fixing hole	28.5	28.5	28.5			
Gew.: Rail weight, specific (kg/m)	3.0	3.1	2.8			

Available options for BM S 25



BM W 25 Dimensions and capacities



	BM W 25-A	BM W 25-B	BM W 25-C	BM W 25-D	BM W 25-E	BM W 25-F	BM W 25-G
A: System height	36	36	40	40	40	36	36
B: Carriage width	70	70	48	48	57	48	48
B2: Distance between locating faces	23.5	23.5	12.5	12.5	17	12.5	12.5
C1: Position of center front lube hole	5.5	5.5	9.5	9.5	9.5	5.5	5.5
C3: Position of lateral lube hole	5.5	5.5	9.5	9.5	9.5	5.5	5.5
C4: Position of lateral lube hole	13.75	23.25	18.75	20.75	18.75	18.75	20.75
C7: Position of top lube hole	13.5	23	18.5	20.5	18.5	18.5	20.5
J: Carriage height	30.5	30.5	34.5	34.5	34.5	30.5	30.5
L: Carriage length	84.5	103.5	84.5	103.5	84.5	84.5	103.5
L1: Exterior fixing hole spacing	45	45	35	50	35	35	50
L2: Interior fixing hole spacing	40	40	-	-	35	-	-
L6: Steel body length	59.5	78.5	59.5	78.5	59.5	59.5	78.5
N: Lateral fixing hole spacing	57	57	35	35	-	35	35
O: Reference face height	7	7	10	10	15	10	10
Capacities and weights							
C0: Static load capacity (N)	46100	60300	46100	60300	46100	46100	60300
C100: Dynamic load capacity (N)	21100	25500	21100	25500	21100	21100	25500
MOQ: Static cross moment capacity (Nm)	631	825	631	825	631	631	825
MOL: Static longitud. moment capacity (Nm)	513	863	513	863	513	513	863
MQ: Dyn. cross moment capacity (Nm)	289	349	289	349	289	289	349
ML: Dyn. longitud. moment capacity (Nm)	235	365	235	365	235	235	365
Gew: Carriage weight (kg)	0.7	0.9	0.6	0.8	0.7	0.6	0.7

Available options for BM W 25



BM S 30 Drawings

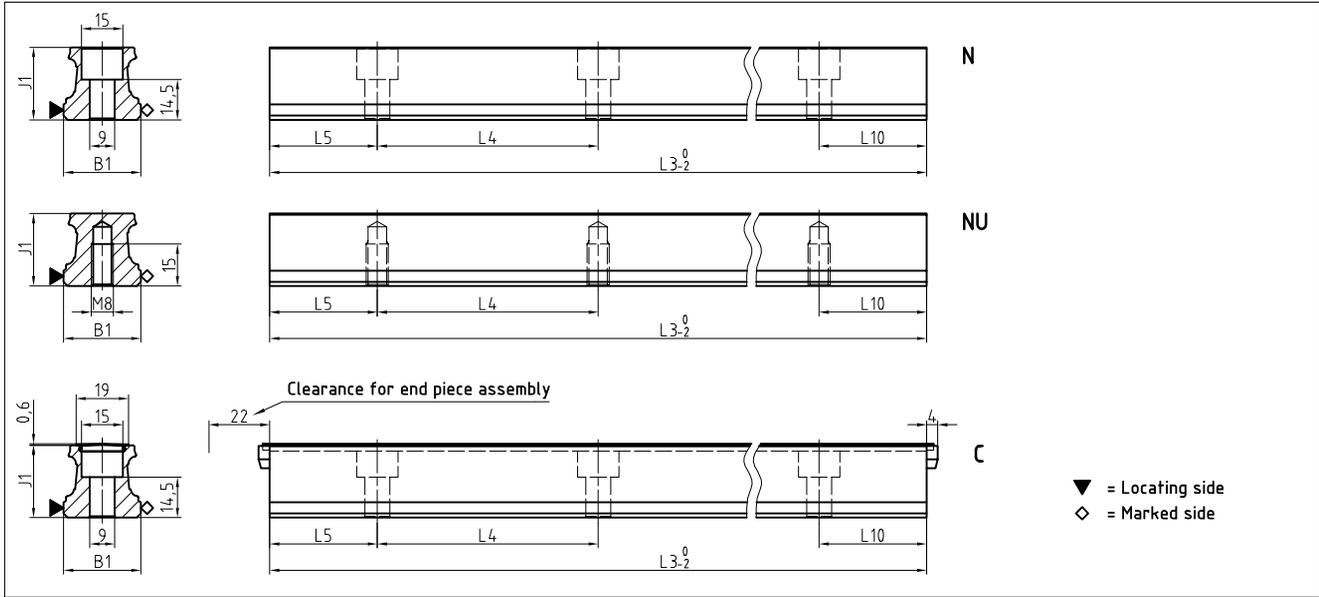

BM W 30 Drawings

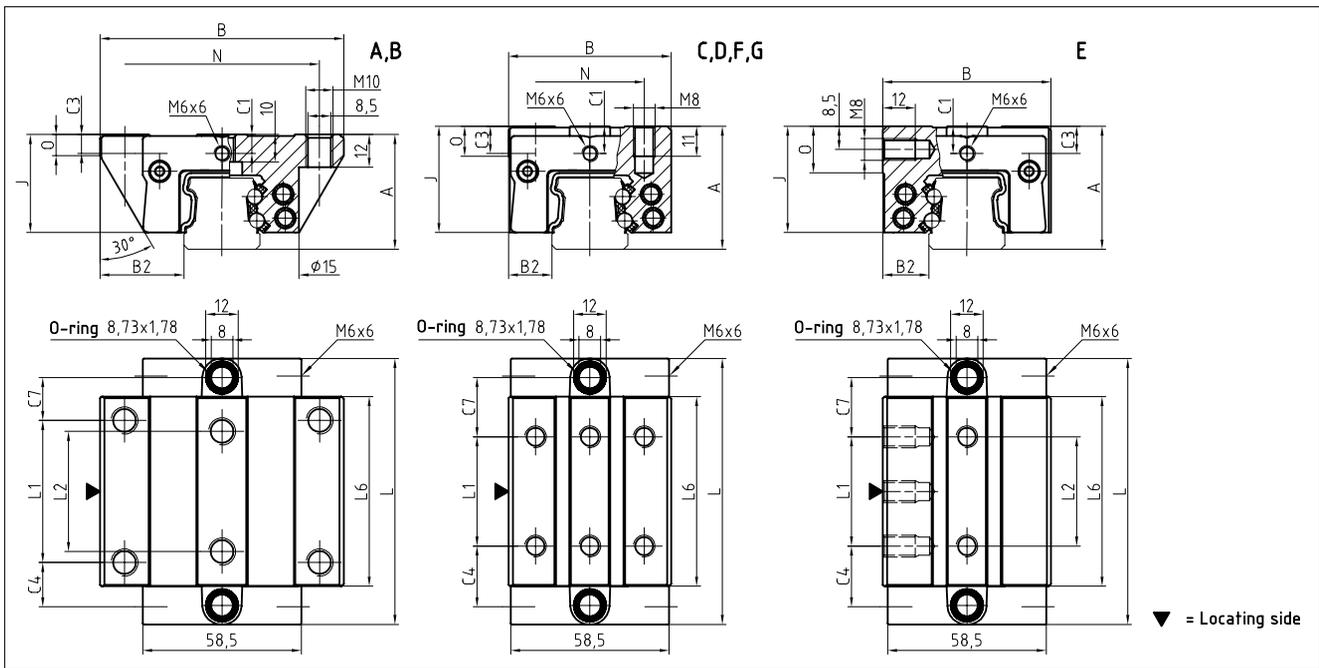

BM W 30 Rigidity diagram

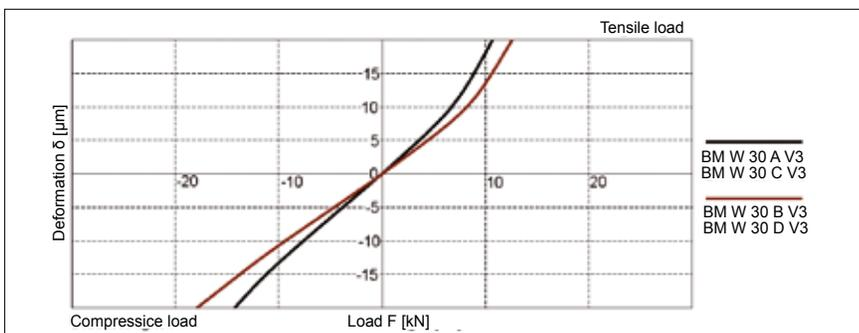

BM W 30 Load rating

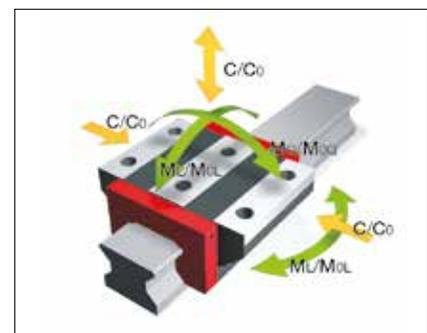

4.2 Technical data and options

BM Size 30

BM S 30 Dimensions



	BM S 30-N	BM S 30-NU	BM S 30-C			
B1: Rail width	28	28	28			
J1: Rail height	26	26	26			
L3: Rail length max.	6000	6000	6000			
L4: Spacing of fixing holes	80	80	80			
L5/L10: Position of first/last fixing hole	38.5	38.5	38.5			
Gew: Rail weight, specific (kg/m)	4.3	4.5	4.1			

Available options for BM S 30



BM W 30 Dimensions and capacities



	BM W 30-A	BM W 30-B	BM W 30-C	BM W 30-D	BM W 30-E	BM W 30-F	BM W 30-G
A: System height	42	42	45	45	45	42	42
B: Carriage width	90	90	60	60	62	60	60
B2: Distance between locating faces	31	31	16	16	17	16	16
C1: Position of center front lube hole	7	7	10	10	10	7	7
C3: Position of lateral lube hole	7	7	10	10	10	7	7
C4: Position of lateral lube hole	16.2	27.2	22.2	23.2	22.2	22.2	23.2
C7: Position of top lube hole	15.7	26.7	21.7	22.7	21.7	21.7	22.7
J: Carriage height	35.9	35.9	38.9	38.9	38.9	35.9	35.9
L: Carriage length	97.4	119.4	97.4	119.4	97.4	97.4	119.4
L1: Exterior fixing hole spacing	52	52	40	60	40	40	60
L2: Interior fixing hole spacing	44	44	-	-	40	-	-
L6: Steel body length	69.4	91.4	69.4	91.4	69.4	69.4	91.4
N: Lateral fixing hole spacing	72.	72	40	40	-	40	40
O: Reference face height	8	8	11	11	17	11	11
Capacities and weights							
C0: Static load capacity (N)	63700	83300	63700	83300	63700	63700	83300
C100: Dynamic load capacity (N)	29200	35300	29200	35300	29200	29200	35300
MOQ: Static cross moment capacity (Nm)	1084	1414	1084	1414	1084	1084	1414
MOL: Static longitud. moment capacity (Nm)	829	1390	829	1390	829	829	1390
MQ: Dyn. cross moment capacity (Nm)	497	599	497	599	497	497	599
ML: Dyn. longitud. moment capacity (Nm)	380	589	380	589	380	380	589
Gew: Carriage weight (kg)	1.2	1.5	1.0	1.3	1.0	0.9	1.2

Available options for BM W 30



BM S 35 Drawings

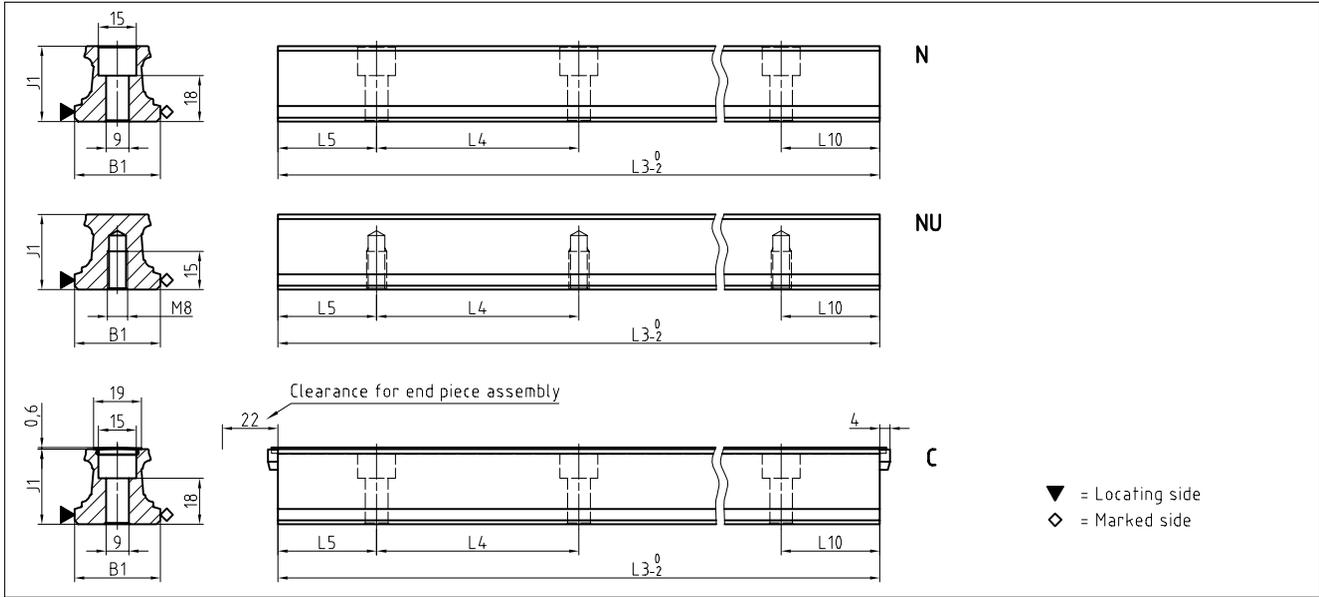

BM W 35 Drawings

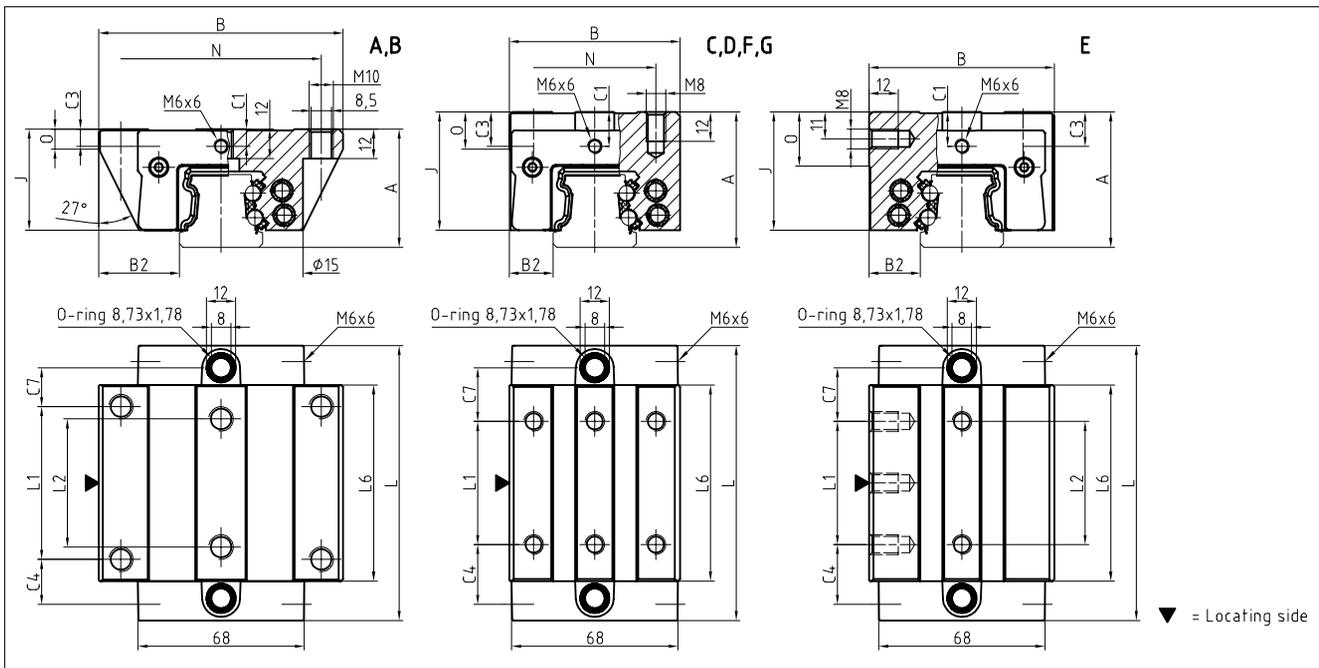

BM W 35 Rigidity diagram

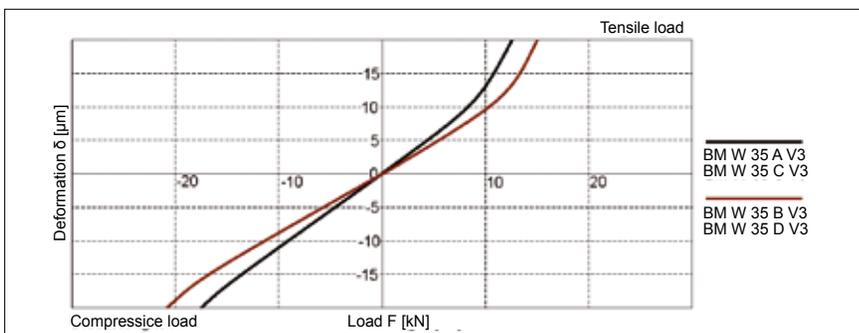

BM W 35 Load rating

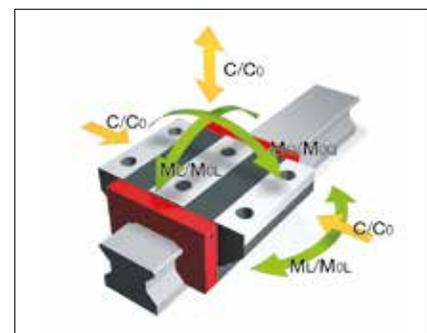

4.2 Technical data and options

BM Size 35

BM S 35 Dimensions



	BM S 35-N	BM S 35-NU	BM S 35-C			
B1: Rail width	34	34	34			
J1: Rail height	29.5	29.5	29.5			
L3: Rail length max.	6000	6000	6000			
L4: Spacing of fixing holes	80	80	80			
L5/L10: Position of first/last fixing hole	38.5	38.5	38.5			
Gew: Rail weight, specific (kg/m)	5.4	5.7	5.2			

Available options for BM S 35



BM W 35 Dimensions and capacities



	BM W 35-A	BM W 35-B	BM W 35-C	BM W 35-D	BM W 35-E	BM W 35-F	BM W 35-G
A: System height	48	48	55	55	55	48	48
B: Carriage width	100	100	70	70	76	70	70
B2: Distance between locating faces	33	33	18	18	21	18	18
C1: Position of center front lube hole	7	7	14	14	14	7	7
C3: Position of lateral lube hole	7	7	14	14	14	7	7
C4: Position of lateral lube hole	18.3	31.05	24.3	26.05	24.3	24.3	26.05
C7: Position of top lube hole	15.8	28.55	21.8	23.55	21.8	21.8	23.55
J: Carriage height	41	41	48	48	48	41	41
L: Carriage length	111.6	137.1	111.6	137.1	111.6	111.6	137.1
L1: Exterior fixing hole spacing	62	62	50	72	50	50	72
L2: Interior fixing hole spacing	52	52	-	-	50	-	-
L6: Steel body length	79.6	105.1	79.6	105.1	79.6	79.6	105.1
N: Lateral fixing hole spacing	82	82	50	50	-	50	50
O: Reference face height	8.5	8.5	15	15	22	8.5	8.5
Capacities and weights							
C0: Static load capacity (N)	84400	110300	84400	110300	84400	84400	110300
C100: Dynamic load capacity (N)	38700	46700	38700	46700	38700	38700	46700
MOQ: Static cross moment capacity (Nm)	1566	2048	1566	2048	1566	1566	2048
MOL: Static longitud. moment capacity (Nm)	1252	2104	1252	2104	1252	1252	2104
MQ: Dyn. cross moment capacity (Nm)	718	867	718	867	718	718	867
ML: Dyn. longitud. moment capacity (Nm)	574	891	574	891	574	574	891
Gew: Carriage weight (kg)	1.8	2.3	1.7	2.2	1.9	1.4	1.8

Available options for BM W 35



BM S 45 Drawings

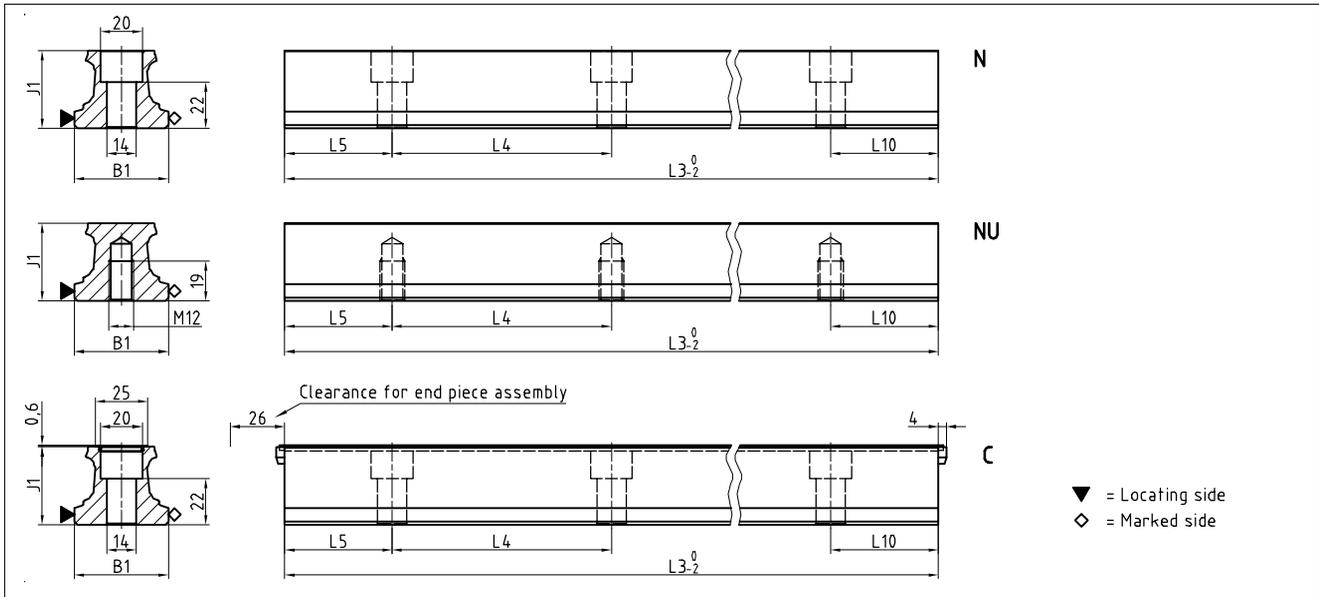

BM W 45 Drawings

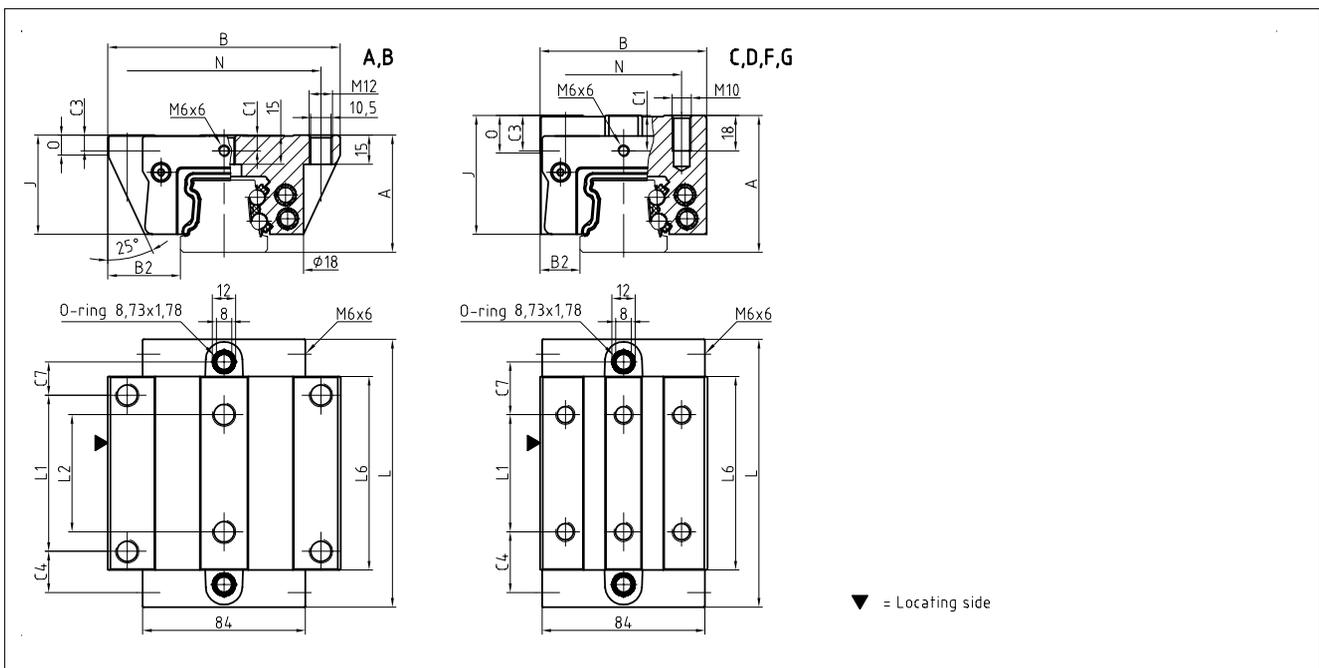

BM W 45 Rigidity diagram

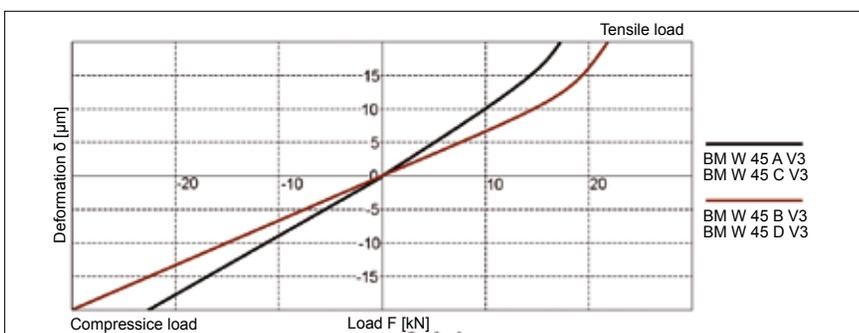

BM W 45 Load rating

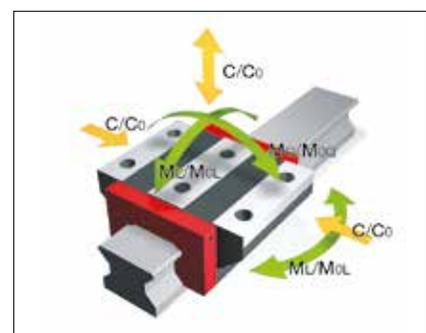

4.2 Technical data and options

BM Size 45

BM S 45 Dimensions



	BM S 45-N	BM S 45-NU	BM S 45-C			
B1: Rail width	45	45	45			
J1: Rail height	37	37	37			
L3: Rail length max.	6000	6000	6000			
L4: Spacing of fixing holes	105	105	105			
L5/L10: Position of first/last fixing hole	51	51	51			
Gew.: Rail weight, specific (kg/m)	8.8	9.3	8.6			

Available options for BM S 45



BM W 45 Dimensions and capacities



	BM W 45-A	BM W 45-B	BM W 45-C	BM W 45-D	BM W 45-F	BM W 45-G	
A: System height	60	60	70	70	60	60	
B: Carriage width	120	120	86	86	86	86	
B2: Distance between locating faces	37.5	37.5	20.5	20.5	20.5	20.5	
C1: Position of center front lube hole	8	8	18	18	8	8	
C3: Position of lateral lube hole	8	8	18	18	8	8	
C4: Position of lateral lube hole	21.05	36.8	31.05	36.8	31.05	36.8	
C7: Position of top lube hole	17.05	32.8	27.05	32.8	27.05	32.8	
J: Carriage height	50.8	50.8	60.8	60.8	50.8	50.8	
L: Carriage length	137.1	168.6	137.1	168.6	137.1	168.6	
L1: Exterior fixing hole spacing	80	80	60	80	60	80	
L2: Interior fixing hole spacing	60	60	-	-	-	-	
L6: Steel body length	99.1	130.6	99.1	130.6	99.1	130.6	
N: Lateral fixing hole spacing	100	100	60	60	60	60	
O: Reference face height	10	10	19	19	10	10	
Capacities and weights							
C0: Static load capacity (N)	134800	176300	134800	176300	134800	176300	
C100: Dynamic load capacity (N)	61900	74700	61900	74700	61900	74700	
MOQ: Static cross moment capacity (Nm)	3193	4175	3193	4175	3193	4175	
MOL: Static longitud. moment capacity (Nm)	2498	4199	2498	4199	2498	4199	
MQ: Dyn. cross moment capacity (Nm)	1466	1769	1466	1769	1466	1769	
ML: Dyn. longitud. moment capacity (Nm)	1147	1779	1147	1779	1147	1779	
Gew: Carriage weight (kg)	3.3	4.2	3.3	4.3	2.7	3.5	

Available options for BM W 45



BM Rails Accessories overview

Accessories	BM S 15	BM S 20	BM S 25	BM S 30	BM S 35	BM S 45	
Plugs:							
Plastic plugs	BRK 15	BRK 20	BRK 25	BRK 30	BRK 35	BRK 45	
Cover strips:							
Cover strip (spare part)	BAC 15	BAC 20	BAC 25	BAC 30	BAC 35	BAC 45	
Securing band for cover strip (spare part)	BSC 15-BAC	BSC 20-BAC	BSC 25-BAC	BSC 30-BAC	BSC 35-BAC	BSC 45-BAC	
End piece for cover strip (spare part)	EST 15-BAC	EST 20-BAC	EST 25-BAC	EST 30-BAC	EST 35-BAC	EST 45-BAC	
Assembly tools:							
Installation tool for cover strip	BWC 15	BWC 20	BWC 25	BWC 30	BWC 35	BWC 45	

BM Carriages Accessories overview

Accessories	BM W 15	BM W 20	BM W 25	BM W 30	BM W 35	BM W 45	
Additional wipers:							
Additional wipers NBR	ZBN 15	ZBN 20	ZBN 25	ZBN 30	ZBN 35	ZBN 45	
Additional wipers Viton	ZBV 15	ZBV 20	ZBV 25	ZBV 30	ZBV 35	ZBV 45	
Metal wiper	ABM 15	ABM 20	ABM 25	ABM 30	ABM 35	ABM 45	
Bellows:							
Bellows	-	FBB 20	FBB 25	FBB 30	FBB 35	FBB 45	
Adapter plate for bellows (spare part)	-	ZPB 20	ZPB 25	ZPB 30	ZPB 35	ZPB 45	
End plate for bellows (spare part)	-	EPB 20	EPB 25	EPB 30	EPB 35	EPB 45	
Assembly rails:							
Assembly rail	MBM 15	MBM 20	MBM 25	MBM 30	MBM 35	MBM 45	
Lubrication plates:							
Lubrication plate	SPL 15-BM	SPL 20-BM	SPL 25-BM	SPL 30-BM	SPL 35-BM	SPL 45-BM	
Front plates:							
Cross wiper for front plate (spare part)	QAS 15-STB	QAS 20-STB	QAS 25-STB	QAS 30-STB	QAS 35-STB	QAS 45-STB	
Lube nipples:							
Hydraulic-type grease nipple straight	-	SN 6	SN 6	SN 6	SN 6	SN 6	
Hydraulic-type grease nipple 45°	-	SN 6-45	SN 6-45	SN 6-45	SN 6-45	SN 6-45	
Hydraulic-type grease nipple 90°	-	SN 6-90	SN 6-90	SN 6-90	SN 6-90	SN 6-90	
Flush type grease nipple M3	SN 3-T	SN 3-T	-	-	-	-	
Flush type grease nipple M6	-	SN 6-T	SN 6-T	SN 6-T	SN 6-T	SN 6-T	
Grease gun for SN 3-T und SN 6-T	SFP-T3	SFP-T3	SFP-T3	SFP-T3	SFP-T3	SFP-T3	
Lube adapters:							
Straight screw-in connection M3	SA 3-D3	SA 3-D3	-	-	-	-	
Lubrication adapter M8 round-head	-	SA 6-RD-M8	SA 6-RD-M8	SA 6-RD-M8	SA 6-RD-M8	SA 6-RD-M8	
Lubrication adapter M8 hexagon head	-	-	-	SA 6-6KT-M8	SA 6-6KT-M8	SA 6-6KT-M8	
Lubrication adapter G1/8 hexagon head	-	-	-	SA 6-6KT-G1/8	SA 6-6KT-G1/8	SA 6-6KT-G1/8	
Swivel screw connection for pipe d=4 mm	-	SV 6-D4	SV 6-D4	SV 6-D4	SV 6-D4	SV 6-D4	
Swivel screw connection M6	-	SV 6-M6	SV 6-M6	SV 6-M6	SV 6-M6	SV 6-M6	
Swivel screw connection M6 long	-	SV 6-M6-L	SV 6-M6-L	SV 6-M6-L	SV 6-M6-L	SV 6-M6-L	
Swivel screw connection M8	-	SV 6-M8	SV 6-M8	SV 6-M8	SV 6-M8	SV 6-M8	
Swivel screw connection M8 long	-	SV 6-M8-L	SV 6-M8-L	SV 6-M8-L	SV 6-M8-L	SV 6-M8-L	



Plastic plugs

BRK plastic plugs are used as a low-cost method of closing off the rail attachment holes. They can be fitted manually with fairly simple tools. Plastic plugs are recommended for use with protected axes or in environments with low levels of contamination, e.g. handling.

Quantity supplied: Pack of 25 pcs

Order code: **BRK xx**

xx = Size, sample order: 3 x BRK 35 (75 pcs)



Cover strip (spare part)

A BAC cover strip combines technical functionality with simple installation and neat appearance.

Made of stainless spring steel, the strip is suitable for demanding applications with enhanced mechanical and thermal loading.

It provides the following advantages:

- Reliable fixing along the length as it is clipped into a special groove
- Additional fixing of the ends of the strips using locking parts (EST xx-BAC)
- Very robust due to the substantial thickness of the material
- Can be fitted and removed several times
- Protection of the wipers during installation as the rail fixing holes are recessed in the groove
- In any length up to 30 m available

When ordering guide rails with cover strips, they are included in the scope of supply.

Order code: **BAC xx-yy**

xx = Size, yy= Rail length in mm, sample order: 1 x BAC 35-4560

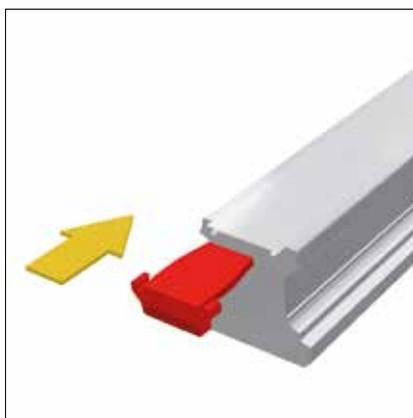

End piece for cover strip (spare part)

EST end pieces are used to close the ends of BAC cover strips. To do this, these plastic parts are inserted on both ends of the rail into the gap under the cover strip. Their special design prevents the ends of the cover strip from lifting and reduces the danger of injury on the sharp edges of the cover strip.

Order code: **EST xx-BAC**

xx = Size, sample order: 2 x EST 35-BAC

**Securing band for cover strip (spare part)**

The BSC securing band for cover strips is used to secure the ends when mechanical loads are high. To do this, the protruding band ends are cut off at right angles and burr-free, and a fastening thread is fitted to the front face of the rail.

Securing bands are used in applications with high vibration levels, with rails in open chip spaces, with rail lengths of less than 600 mm or for vertical fitting and the subsequent risk that EST endpieces could fall out.

The securing band also covers the ends of the cover strips and reduces the risk of injury on the sharp corners of the ends.

Order code: **BSC xx-MAC**

xx = Size, order example: 2 x BSC 65-MAC

**Installation tool for cover strip**

A BWC fitting tool is used to simplify the fitting of an MAC cover strip. At the same time, it ensures that the cover strip sits securely in the rail groove without any gaps.

Order code: **BWC xx**

xx = Size, sample order: 1 x BWC 35



Additional wiper NBR

Additional ZBN-U nitrile wipers provide additional protection of the carriages in heavily contaminated environments. Due to their flexibility, they can be fitted directly over the rail cross section. It is therefore not necessary to remove the carriage from the rail.

ZBN-U wipers can also be used in combination with ABM metal wipers.

Order code: **ZBN xx-U**

xx = Size, sample order: 2 x ZBN 35-U



Additional wiper Viton

Like ZBN-U wipers, ZBV-U additional wipers provide additional protection of the carriages in heavily contaminated environments. Made of Viton® (fluoroelastomer), they are also suitable for use with aggressive coolants. Since they can be pushed over the rail cross section due to their flexibility, retrofitting is possible without any need to remove the carriage from the rail. ZBV-U wipers can also be used in combination with ABM metal wipers.

Order code: **ZBV xx-U**

xx = Size, sample order: 2 x ZBV 35-U



Metal wiper

Made of stainless steel, ABM metal wipers are used to protect the sealing lips of carriages and additional wipers against hot metal chips. Large and loose dirt particles are pushed away and cannot get jammed due to the controlled dimension of the gap with the rail. Specially adapted types are available for rails using AMS measuring systems.

Metal wipers are ideally used in combination with ZBN-U/ZCV-U additional wipers.

Order code: **ABM xx**

xx= Size, sample order: 1 x ABM 35



Bellows

A standard FBB bellows is available for MONORAIL sizes BM 20 – BM 45, the purpose of which is mainly to provide additional protection against dust and water splashes. The bellows are made of synthetic fabric coated on both sides with plastic. The bellows cover the entire length of the rail profile matching the relevant faceplate of the carriage. The external dimensions of the carriage are not exceeded by the bellows. Installation is simple and takes little time. A ZPB adapter plate is required to attach the bellows to the carriage. The adapter plate is screwed to the front plate of the carriage using a central screw. An EPB end plate is screwed to the end face of the rail. The bellows are fastened by two rivets to both the adapter plate and the front plate. The required adapter and end plates, attachment screws and rivets are supplied with each order for a complete set of bellows. The attachment holes for the end plate are also prepared in the rail when a guideway with bellows is ordered.

Order code: **FBB xx-yy**

xx = Size, yy = Number of folds, sample order: 1 x FBB 35-146



Adapter plate for bellows (spare part)

A ZPB adapter plate is used to attach FBB bellows to the carriage and is included with every order for a bellows. It is made of black anodized aluminium. The outer contour of the adapter plate corresponds to that of the carriage front plate, the bellows and the end plate. The central fastening screw is included in the scope of supply.

Order code: **ZPB xx**

xx = Size, sample order: 2 x ZPB 35

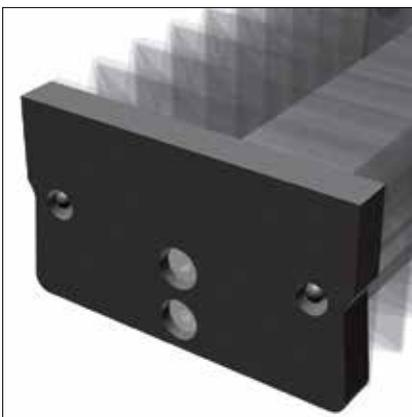

End plate for bellows (spare part)

Made of black anodized aluminium, an EPB end plate is used to attach the FBB bellows to the end of the rail. It is included with every order for a set of bellows. The attachment holes must be drilled in the rail if the bellows are to be retrofitted. For this reason, we recommend the use of induction-hardened rails for retrofits. The outer contour of the end plate corresponds to that of the carriage front plate, the bellows and the adapter plate. Both fastening screws are supplied with the end plate.

Order code: **EPB xx**

xx = Size, sample order: 2 x EPB 35



Assembly rail

An MBM assembly rail is required when a carriage has to be removed from the rail and then reinstalled during the installation of the MONORAIL guideway.

It is advisable to leave the assembly rail in the carriage to protect the balls against contamination. If necessary, the two internal carriage attaching screws can be fitted and tightened through the two holes in the assembly rail.

Order code: **MBM xx**

xx = Size, sample order: 1 x MBM 35



Lubrication plate

An SPL lubrication plate is used wherever long lubrication intervals are required. Thanks to its integral oil reservoir, the rolling elements are supplied with an automatic and uniform supply of lubrication over an extended period.

It is ideally used in dry and clean environments as in handling technology or on the ancillary axes of machine tools.

The advantages are:

- Assured supply of lubrication in any installation position
- Long lubrication intervals of up to 5,000 km or 12 months according to use
- Refill apertures closed with screws
- Reduced outlay on lubrication and accessories
- Low environmental impact thanks to minimum consumption of lubricant
- Wipers have a long service life as oil is also supplied to the top surface of the rail

For maximum travel distances without re-lubrication, the lubrication plates are always used in pairs and the carriages are given an additional filling of grease.

The lubrication plates have the same dimensions as the carriage front plates and are installed in front of these. Retrofitting is possible.

Additional ZBN-U/ZBV-U wipers must be provided in applications in which particles of dirt can come into contact with the guideways.

Order code: **SPL xx-BM**

xx = Size, sample order: 2 x SPL 35-BM



Cross wiper for front plate (spare part)

QAS twin-lip cross wipers, integrated into the end plate, seal the carriage at the ends, thus preventing the ingress of dirt and the loss of lubricant.

As the cross wipers are subject to normal wear, they must be examined regularly and replaced if necessary.

Order code: **QAS xx-STB**

xx = Size, sample order: 1 x QAS 35-STB

4.4 Order key

Individual guide rails and carriages are ordered in accordance with the order codes described below.

Q.v. chapter 2.1 and chapter 4.3 for the order key for accessories.

Separate order codes are used in each case for rails, carriages and accessories. This also applies to different versions of rails and carriages.

All guide components are supplied individually as standard, i.e. unassembled.

If required, SCHNEEBERGER can also supply rails and carriages assembled incl. accessories as complete systems. Please note the ordering instructions in chapter 2.4 if this applies.

Order code for BM Rails

	2x	BM S	25	-N	-G3	-KC	-R1	-958	-29	-29	-CN
Quantity											
Rail											
Size											
Type											
Accuracy											
Straightness											
Reference side											
Rail length L3											
Position of first fixing hole L5											
Position of last fixing hole L10											
Coating											

NB

Q.v. chapter 4.1 to 4.3 for an overview of types, details of shapes, available options and accessories.

Q.v. chapter 2 for a description of the options.

If possible, standard lengths are preferred for L3 rail length.

These are calculated with the table values in chapter 4.2 using the following formula: $L3 = n \times L4 + L5 + L10 \leq L3_{max}$.

Order code for BM Carriages

	4x	BM W	25	-A	-G3	-V1	-R1	-CN	-S10	-LN
Quantity										
Carriage										
Size										
Type										
Accuracy										
Preload										
Reference side										
Coating										
Lube connection										
Lubrication as delivered condition										

NB

Q.v. chapter 4.1 to 4.3 for an overview of types, details of shapes, available options and accessories.

Q.v. chapter 2 for a description of the options.

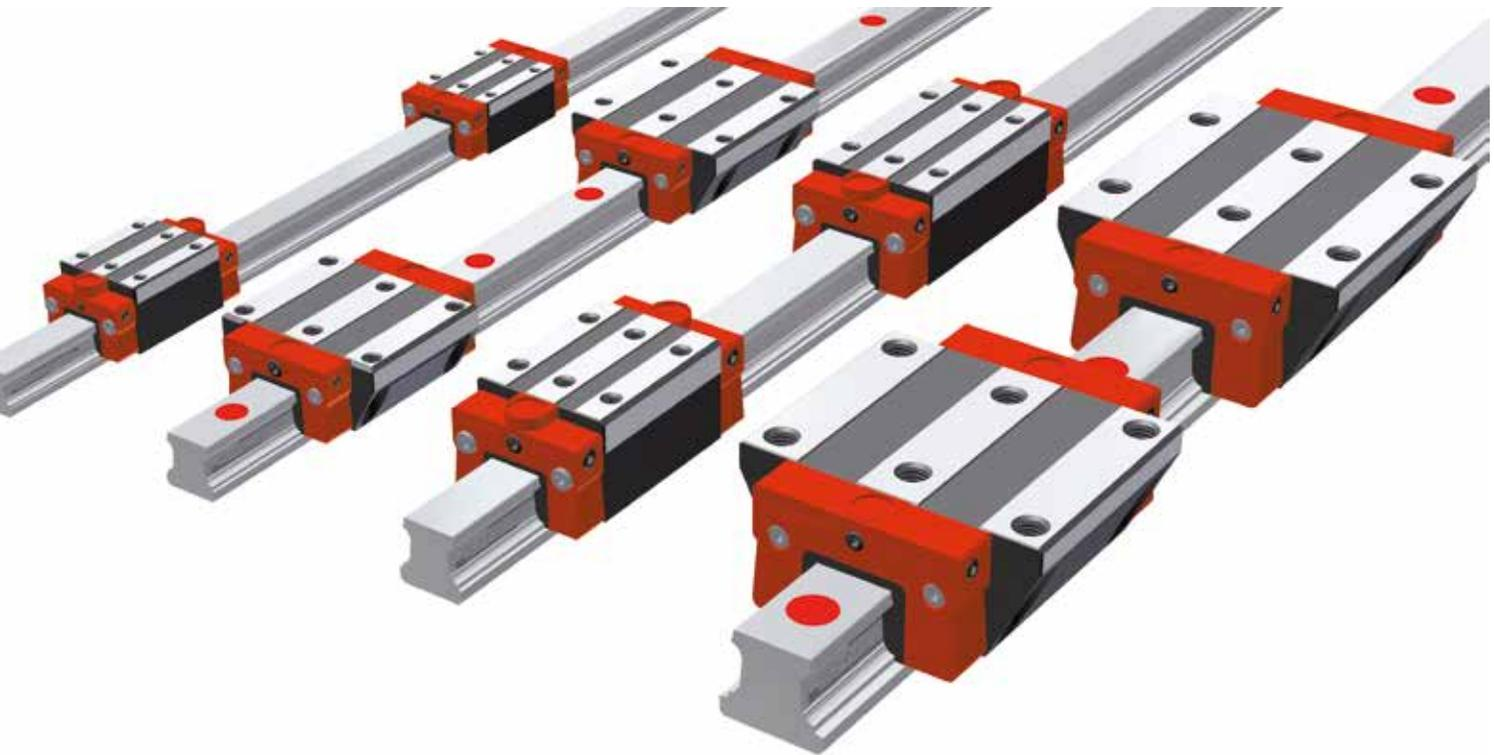

The MONORAIL BM WR/SR systems are linear guides made from corrosion-resistant steel, and are based on the MONORAIL BM ball profiled linear guideway. They were developed specially for specifications which would exceed the requirements of ordinary coatings for linear guideways. This is the case when the performance of the product is impaired by corrosion during processes.

In applications such as machines for foodstuffs, medical technology and cleanrooms MONORAIL BM WR/SR products ensure that the operation of linear axes is clean, accurate, long-term and free of problems.

Furthermore, the MONORAIL WR/SR has the same tried and tested properties of the MONORAIL BM, such as the most effective operating characteristics, high travel speeds and a long operating life.

Features of System MONORAIL BM WR / BM SR

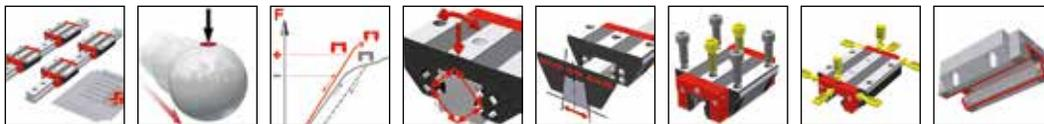

Details see chapter 1

5.1 Overview of types, sizes and available options

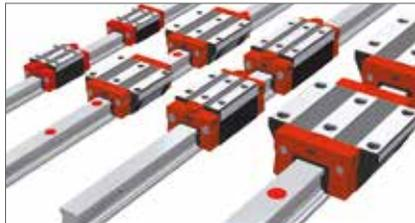

Product overview BM SR Rails	Page 88
Product overview BM WR Carriages	Page 89

5.2 Technical data and options

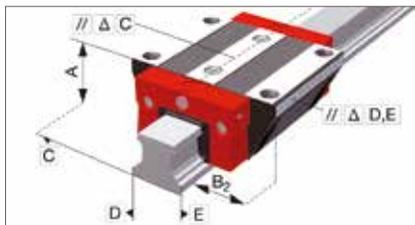

BM WR / BM SR Size 15	Page 90
BM WR / BM SR Size 20	Page 92
BM WR / BM SR Size 25	Page 94
BM WR / BM SR Size 35	Page 96

5.3 Accessories MONORAIL BM WR / BM SR



Accessories overview	Page 98
----------------------	---------

5.4 Order key



Order code for BM SR Rails	Page 99
Order code for BM WR Carriages	Page 99

Product overview BM SR Rails

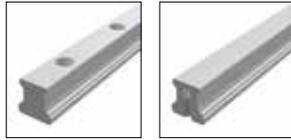

ND
standard,
through hardened

NUD
with tapped holes
at the bottom,
through hardened

Buildsizes / Rail build forms

Size 15	BM SR 15-ND	BM SR 15-NUD			
Size 20	BM SR 20-ND	BM SR 20-NUD			
Size 25	BM SR 25-ND	BM SR 25-NUD			
Size 35	BM SR 35-ND	BM SR 35-NUD			
Features					
Screwable from above	●				
Screwable from below		●			
Small assembly effort		●			

Available options for BM SR Rails

Details see chapter 2

Accuracy

- G1 Very accurate
- G2 Accurate
- G3 Standard

Straightness

- KC Standard

Reference side

- R1 Ref. at bottom
- R2 Ref. on top

Coating

- CN None

Available accessories for BM SR Rails

Details see chapter 5.3

Plugs

5.1 Overview of types, sizes and available options

BM WR Carriages

Product overview BM WR Carriages

					
	A standard	B standard, long	C compact, high	D compact, high, long	F compact
Buildsizes / Carriage build forms					
Size 15	BM WR 15-A		BM WR 15-C		BM WR 15-F
Size 20	BM WR 20-A	BM WR 20-B	BM WR 20-C	BM WR 20-D	
Size 25	BM WR 25-A	BM WR 25-B	BM WR 25-C	BM WR 25-D	
Size 35	BM WR 35-A	BM WR 35-B	BM WR 35-C	BM WR 35-D	
Features					
Screwable from above	•	•	•	•	•
Screwable from below	•	•			
For high loads and moments		•		•	
For medium loads and moments	•		•		•
For limited installation space					•

Available options for BM WR Carriages

Details see chapter 2

Accuracy

-  G1 Very accurate
-  G2 Accurate
-  G3 Standard

Preload

-  V0 very low
-  V1 Low
-  V2 Medium

Reference side

-  R1 Ref. at bottom
-  R2 Ref. on top

Coating

-  CN None

Lube connections

-  S10 Left center
-  S20 Right center
-  S11 Top left
-  S21 Top right
-  S12 Lower left side
-  S22 Lower right side

-  S13 Upper left side
-  S23 Upper right side
-  S32 Left side
-  S42 Right side

Lubrication

-  LN Oil protect
-  LK Customized

Available accessories for BM WR Carriages

Details see chapter 5.3 and 2.1

Additional wipers
Front plates

Bellows
Lube nipples

Assembly rails
Lube adapters

Lubrication plates

BM SR 15 Drawings

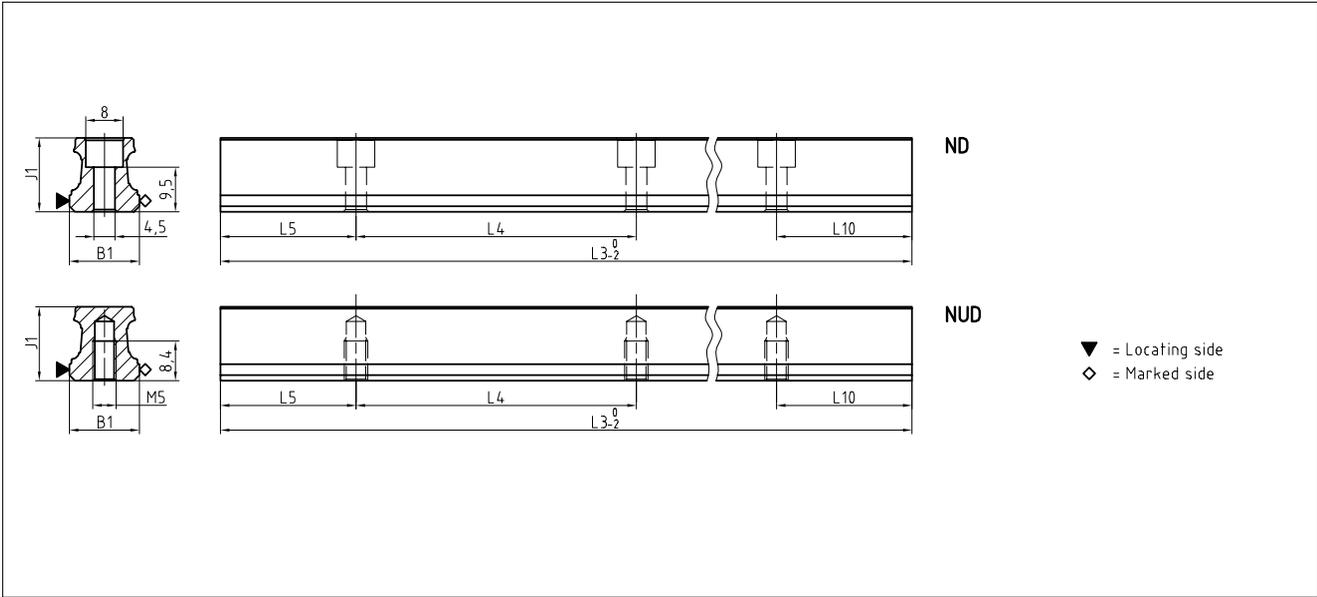

BM WR 15 Drawings

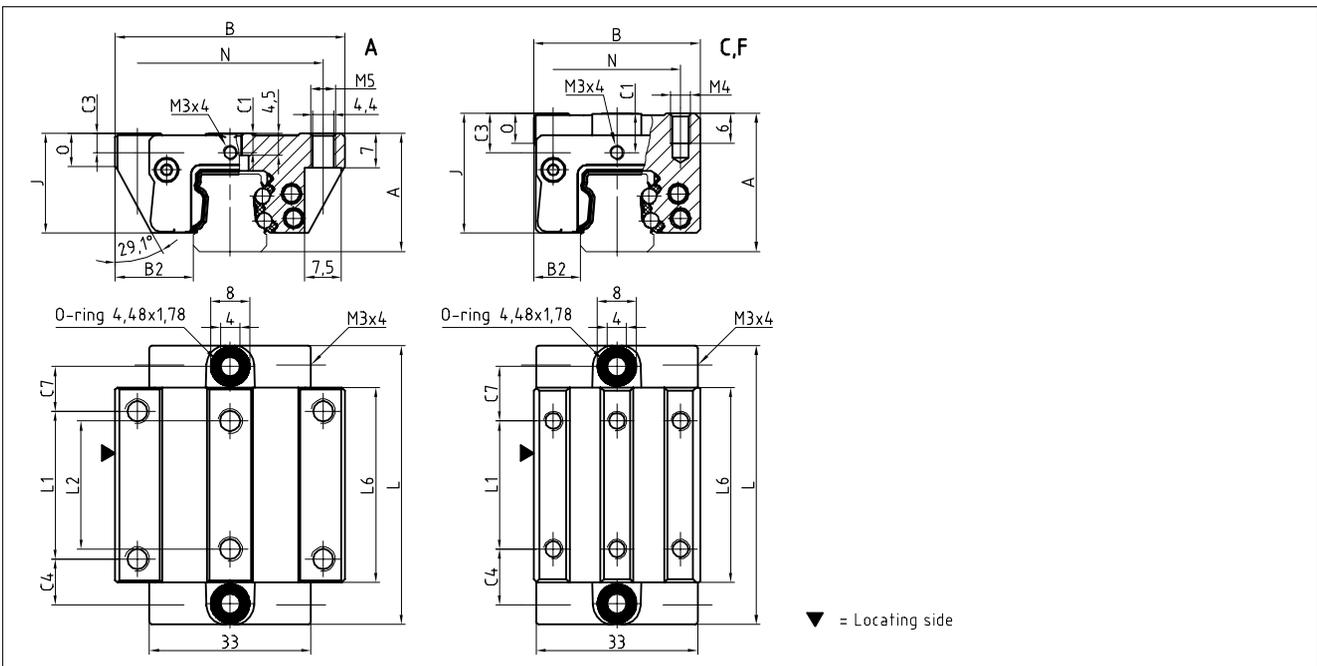

BM WR 15 Rigidity diagram

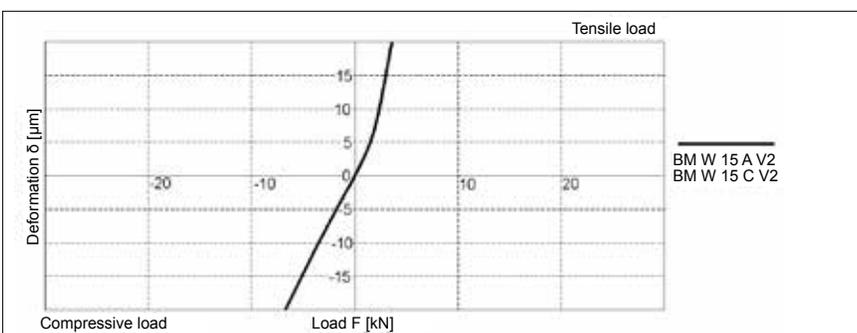

BM WR 15 Load rating

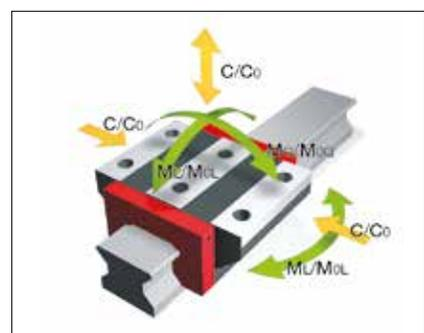

5.2 Technical data and options

BM WR / BM SR Size 15

BM SR 15 Dimensions



	BM SR 15-ND	BM SR 15-NUD			
B1: Rail width	15	15			
J1: Rail height	15.7	15.7			
L3: Rail length max.	1000	1000			
L4: Spacing of fixing holes	60	60			
L5/L10: Position of first/last fixing hole	28.5	28.5			
Gew.: Rail weight, specific (kg/m)	1.4	1.4			

Available options for BM SR 15



BM WR 15 Dimensions and capacities



	BM WR 15-A	BM WR 15-C	BM WR 15-F		
A: System height	24	28	24		
B: Carriage width	47	34	34		
B2: Distance between locating faces	16	9.5	9.5		
C1: Position of center front lube hole	4	8	4		
C3: Position of lateral lube hole	4	8	4		
C4: Position of lateral lube hole	9.3	11.3	11.3		
C7: Position of top lube hole	9.05	11.05	11.05		
J: Carriage height	20.2	24.2	20.2		
L: Carriage length	56.6	56.6	56.6		
L1: Exterior fixing hole spacing	30	26	26		
L2: Interior fixing hole spacing	26	-	-		
L6: Steel body length	39.6	39.6	39.6		
N: Lateral fixing hole spacing	38	26	26		
O: Reference face height	7	6	5.5		
Capacities and weights					
C0: Static load capacity (N)	16660	16660	16660		
C100: Dynamic load capacity (N)	7650	7650	7650		
MOQ: Static cross moment capacity (Nm)	154	154	154		
MOL: Static longitud. moment capacity (Nm)	124	124	124		
MQ: Dyn. cross moment capacity (Nm)	71	71	71		
ML: Dyn. longitud. moment capacity (Nm)	57	57	57		
Gew.: Carriage weight (kg)	0.2	0.3	0.2		

Available options for BM WR 15

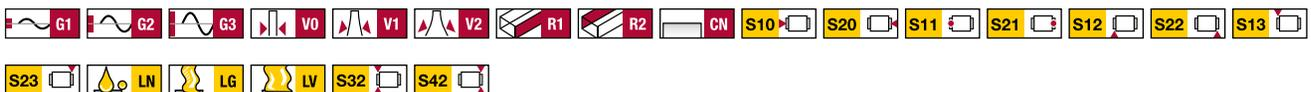

BM SR 20 Drawings

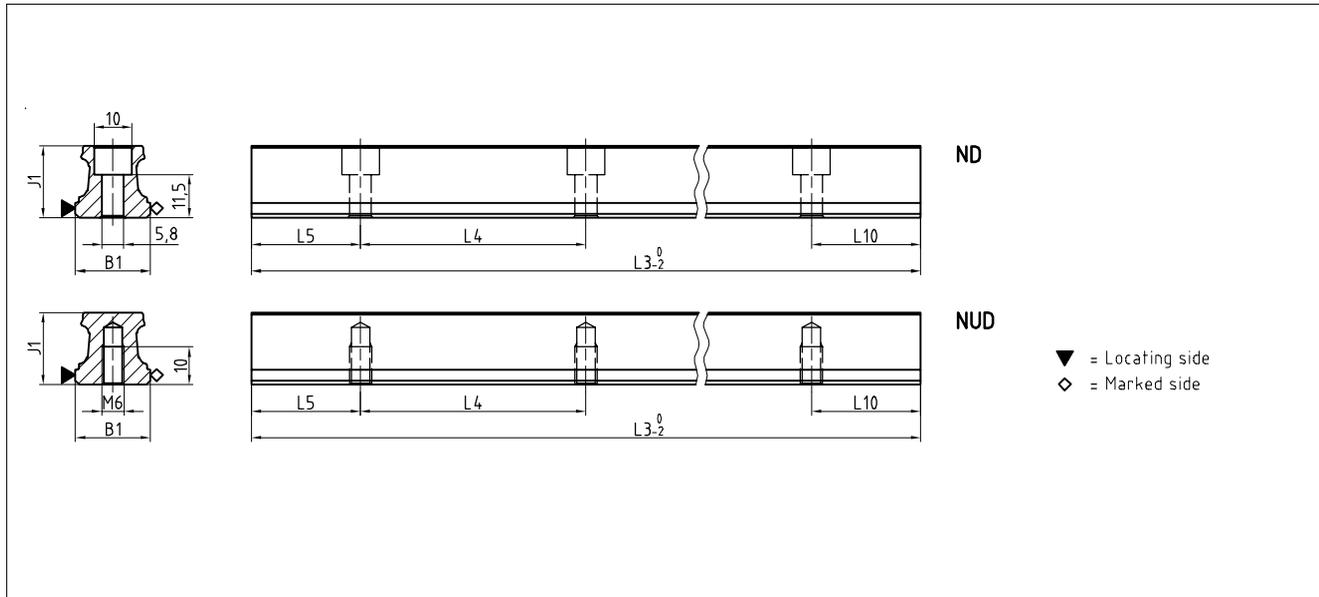

BM WR 20 Drawings

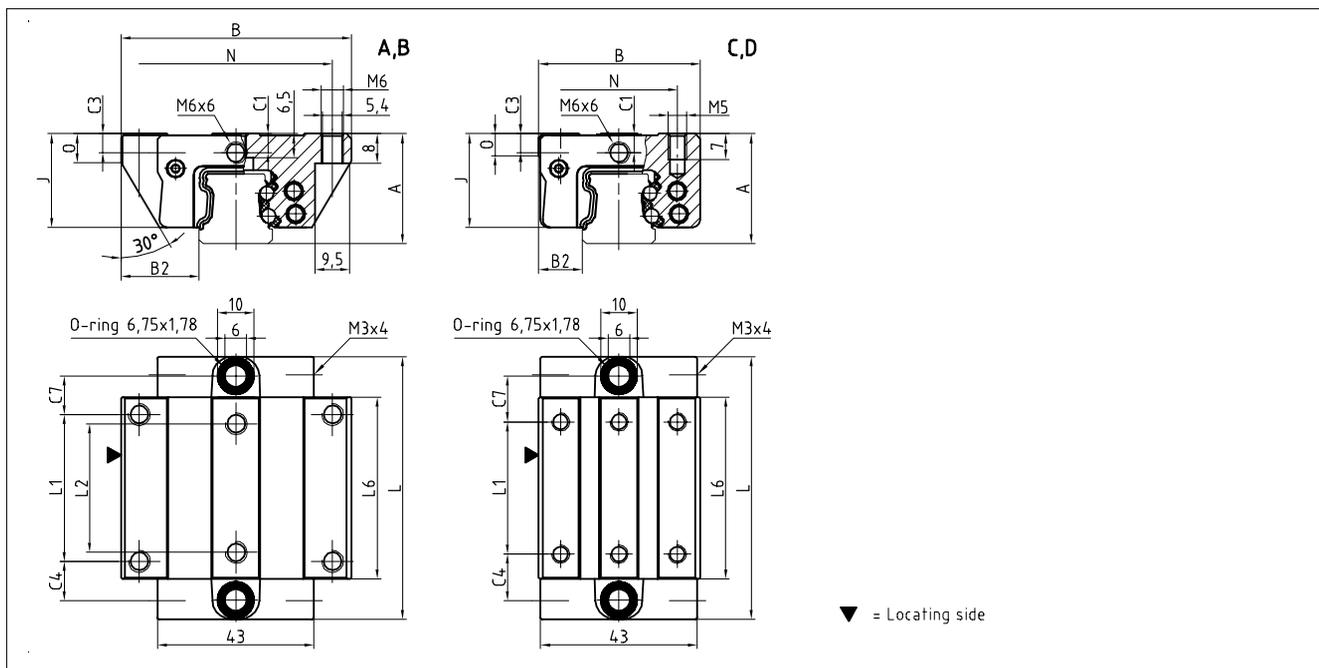

BM WR 20 Rigidity diagram

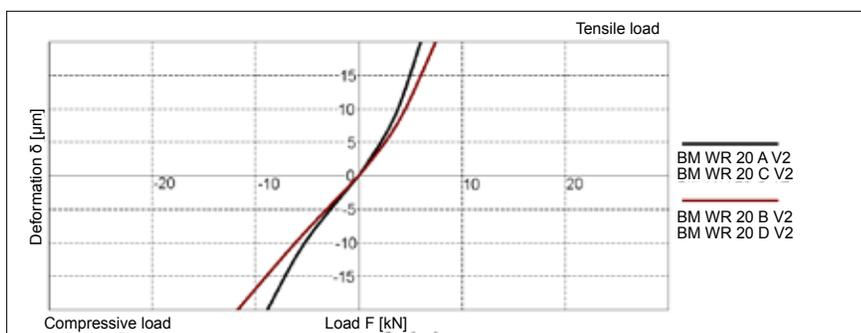

BM WR 20 Load rating

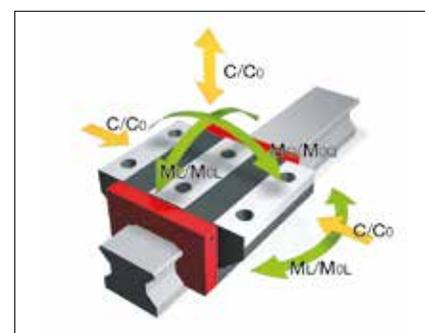

5.2 Technical data and options

BM WR / BM SR Size 20

BM SR 20 Dimensions



	BM SR 20-ND	BM SR 20-NUD			
B1: Rail width	20	20			
J1: Rail height	19	19			
L3: Rail length max.	1000	1000			
L4: Spacing of fixing holes	60	60			
L5/L10: Position of first/last fixing hole	28.5	28.5			
Gew.: Rail weight, specific (kg/m)	2.2	2.3			

Available options for BM SR 20



BM WR 20 Dimensions and capacities



	BM WR 20-A	BM WR 20-B	BM WR 20-C	BM WR 20-D		
A: System height	30	30	30	30		
B: Carriage width	63	63	44	44		
B2: Distance between locating faces	21.5	21.5	12	12		
C1: Position of center front lube hole	5.2	5.2	5.2	5.2		
C3: Position of lateral lube hole	5.2	5.2	5.2	5.2		
C4: Position of lateral lube hole	10.75	18.75	12.75	13.75		
C7: Position of top lube hole	10.25	18.25	12.25	13.25		
J: Carriage height	25.5	25.5	25.5	25.5		
L: Carriage length	71.5	87.5	71.5	87.5		
L1: Exterior fixing hole spacing	40	40	36	50		
L2: Interior fixing hole spacing	35	35	-	-		
L6: Steel body length	49.5	65.5	49.5	65.5		
N: Lateral fixing hole spacing	53	53	32	32		
O: Reference face height	8	8	6	6		
Capacities and weights						
C0: Static load capacity (N)	26690	34935	26690	34935		
C100: Dynamic load capacity (N)	12240	14790	12240	14790		
MOQ: Static cross moment capacity (Nm)	317	417	317	417		
MOL: Static longitud. moment capacity (Nm)	248	421	248	421		
MQ: Dyn. cross moment capacity (Nm)	145	175	145	175		
ML: Dyn. longitud. moment capacity (Nm)	114	177	114	177		
Gew: Carriage weight (kg)	0.5	0.6	0.4	0.5		

Available options for BM WR 20



BM SR 25 Drawings

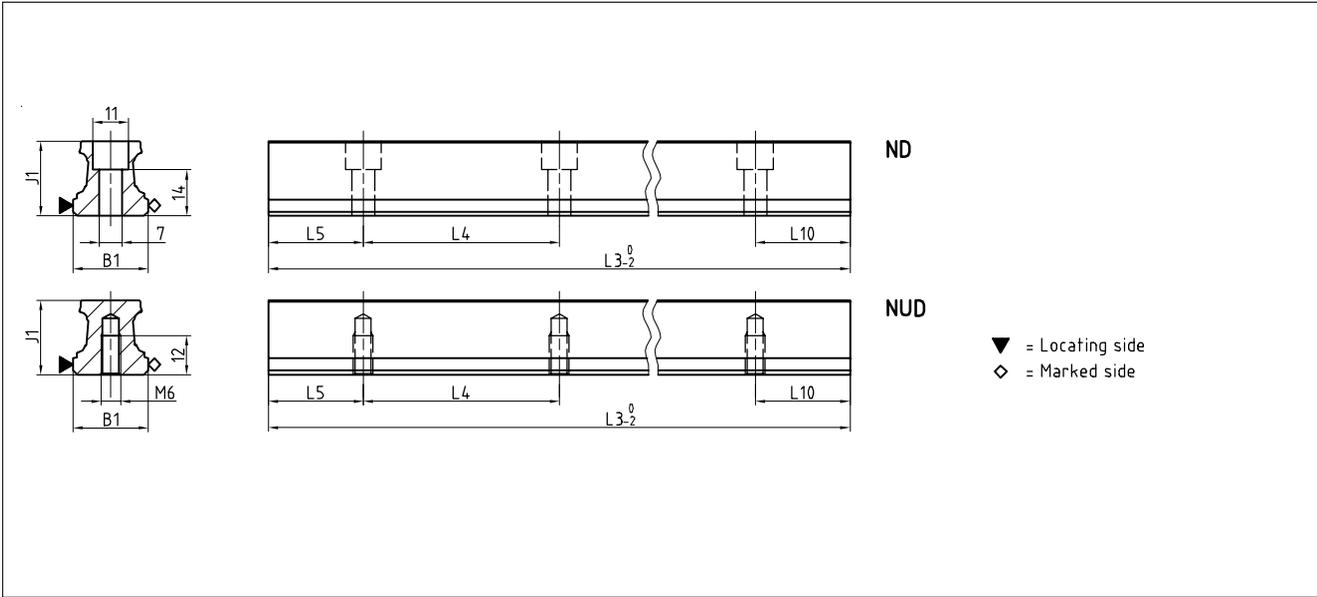

BM WR 25 Drawings

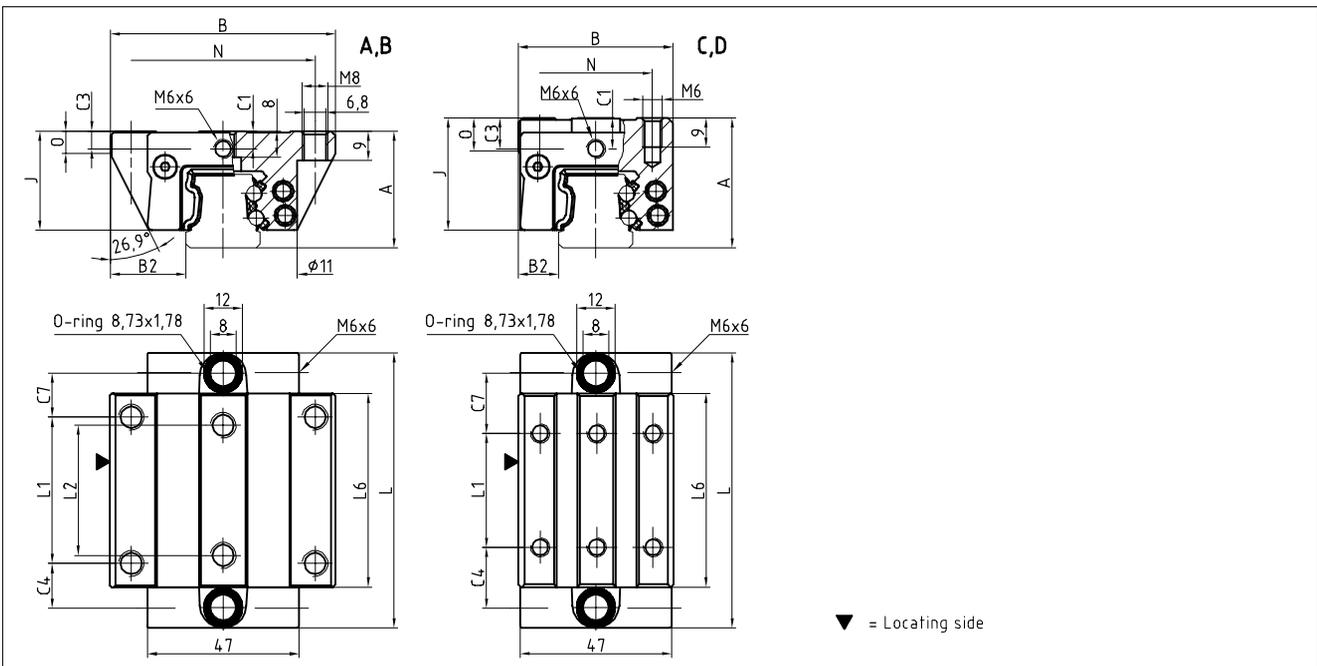

BM WR 25 Rigidity diagram

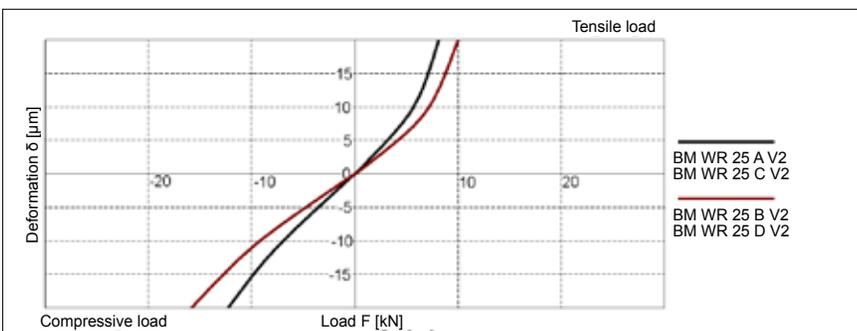

BM WR 25 Load rating

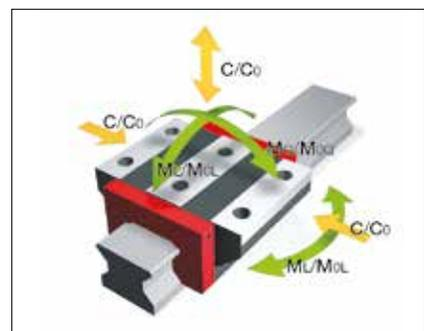

5.2 Technical data and options

BM WR / BM SR Size 25

BM SR 25 Dimensions

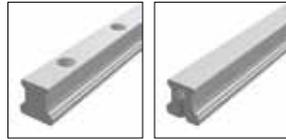

	BM SR 25-ND	BM SR 25-NUD			
B1: Rail width	23	23			
J1: Rail height	22.7	22.7			
L3: Rail length max.	1000	1000			
L4: Spacing of fixing holes	60	60			
L5/L10: Position of first/last fixing hole	28.5	28.5			
Gew.: Rail weight, specific (kg/m)	3.0	3.1			

Available options for BM SR 25



BM WR 25 Dimensions and capacities



	BM WR 25-A	BM WR 25-B	BM WR 25-C	BM WR 25-D		
A: System height	36	36	40	40		
B: Carriage width	70	70	48	48		
B2: Distance between locating faces	23.5	23.5	12.5	12.5		
C1: Position of center front lube hole	5.5	5.5	9.5	9.5		
C3: Position of lateral lube hole	5.5	5.5	9.5	9.5		
C4: Position of lateral lube hole	13.75	23.35	18.75	20.75		
C7: Position of top lube hole	13.5	23	18.5	20.5		
J: Carriage height	30.5	30.5	34.5	34.5		
L: Carriage length	84.5	103.5	84.5	103.5		
L1: Exterior fixing hole spacing	45	45	35	50		
L2: Interior fixing hole spacing	40	40	-	-		
L6: Steel body length	59.5	78.5	59.5	78.5		
N: Lateral fixing hole spacing	57	57	35	35		
O: Reference face height	7	7	11	11		
Capacities and weights						
C0: Static load capacity (N)	39185	51255	39185	51255		
C100: Dynamic load capacity (N)	17935	21675	17935	21675		
MOQ: Static cross moment capacity (Nm)	536	701	536	701		
MOL: Static longitud. moment capacity (Nm)	436	734	436	734		
MQ: Dyn. cross moment capacity (Nm)	246	297	246	297		
ML: Dyn. longitud. moment capacity (Nm)	200	310	200	310		
Gew: Carriage weight (kg)	0.7	0.9	0.6	0.8		

Available options for BM WR 25

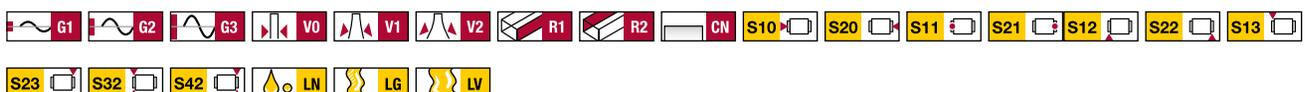

BM SR 35 Drawings

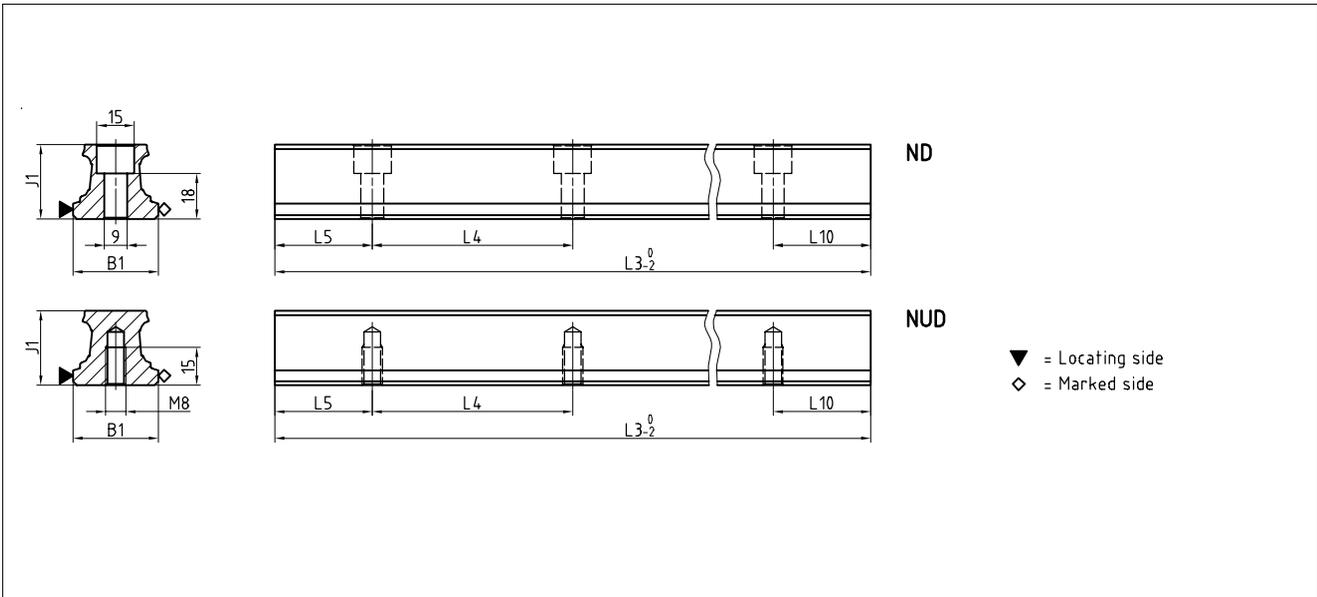

BM WR 35 Drawings

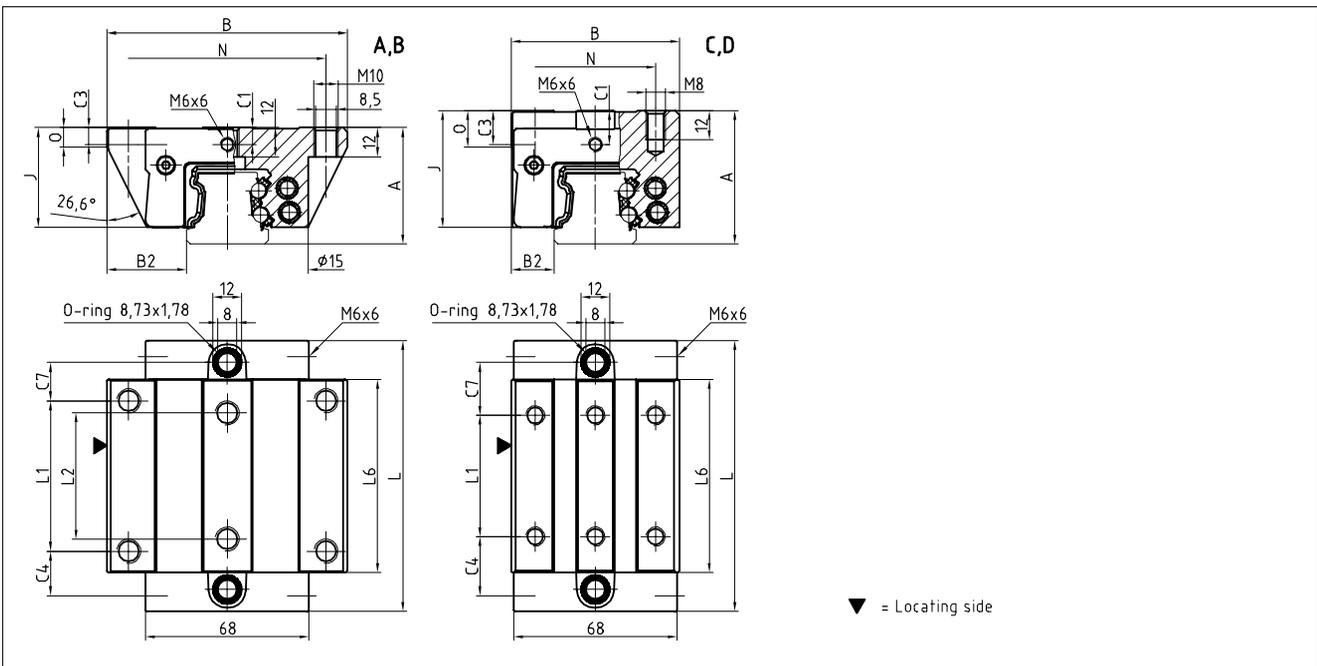

BM WR 35 Rigidity diagram

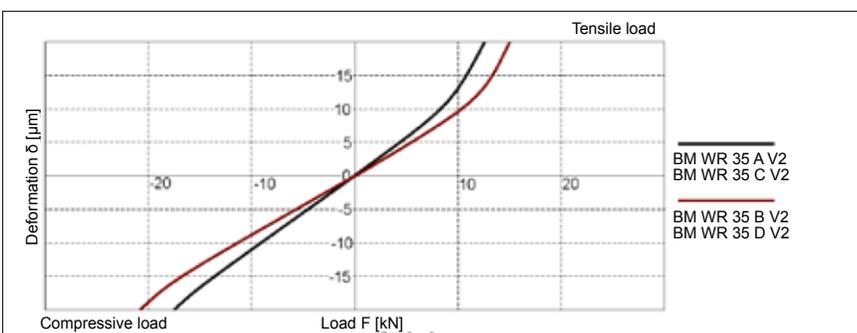

BM WR 35 Load rating

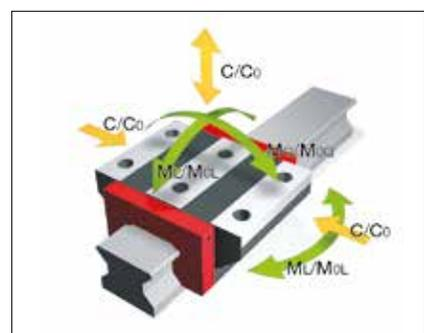

5.2 Technical data and options

BM WR / BM SR Size 35

BM SR 35 Dimensions

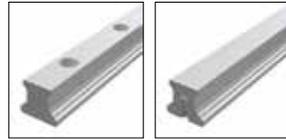

	BM SR 35-ND	BM SR 35-NUD			
B1: Rail width	34	34			
J1: Rail height	29.5	29.5			
L3: Rail length max.	1000	1000			
L4: Spacing of fixing holes	80	80			
L5/L10: Position of first/last fixing hole	38.5	38.5			
Gew.: Rail weight, specific (kg/m)	5.4	5.7			

Available options for BM SR 35



BM WR 35 Dimensions and capacities



	BM WR 35-A	BM WR 35-B	BM WR 35-C	BM WR 35-D		
A: System height	48	48	55	55		
B: Carriage width	100	100	70	70		
B2: Distance between locating faces	33	33	18	18		
C1: Position of center front lube hole	7	7	14	14		
C3: Position of lateral lube hole	7	7	14	14		
C4: Position of lateral lube hole	18.3	31.05	24.3	26.05		
C7: Position of top lube hole	15.8	28.55	21.8	23.55		
J: Carriage height	41	41	48	48		
L: Carriage length	111.6	137.1	111.6	137.1		
L1: Exterior fixing hole spacing	62	62	50	72		
L2: Interior fixing hole spacing	52	52	-	-		
L6: Steel body length	79.6	105.1	79.6	105.1		
N: Lateral fixing hole spacing	82	82	50	50		
O: Reference face height	8	8	15	15		
Capacities and weights						
C0: Static load capacity (N)	71740	93755	71740	93755		
C100: Dynamic load capacity (N)	32895	39695	32895	39695		
MOQ: Static cross moment capacity (Nm)	1331	1741	1331	1741		
MOL: Static longitud. moment capacity (Nm)	1064	1788	1064	1788		
MQ: Dyn. cross moment capacity (Nm)	610	737	610	737		
ML: Dyn. longitud. moment capacity (Nm)	488	757	488	757		
Gew: Carriage weight (kg)	1.8	2.3	1.7	2.2		

Available options for BM WR 35



BM SR Rails accessories overview

Accessories	BM SR 15	BM SR 20	BM SR 25	BM SR 35		
Plugs:						
Plastic plugs	BRK 15	BRK 20	BRK 25	BRK 35		

BM WR Carriages accessories overview

Accessories	BM WR 15	BM WR 20	BM WR 25	BM WR 35		
Additional wipers:						
Additional wipers NBR	ZBN 15	ZBN 20	ZBN 25	ZBN 35		
Additional wipers Viton	ZBV 15	ZBV 20	ZBV 25	ZBV 35		
Metal wiper	ABM 15	ABM 20	ABM 25	ABM 35		
Bellows:						
Bellow	-	FBB 20	FBB 25	FBB 35		
Adapter plate for bellows (spare part)	-	ZPB 20	ZPB 25	ZPB 35		
End plate for bellows (spare part)	-	EPB 20	EPB 25	EPB 35		
Assembly rails:						
Assembly rail	MBM 15	MBM 20	MBM 25	MBM 35		
Lubrication plates:						
Lubrication plate	SPL 15-BM	SPL 20-BM	SPL 25-BM	SPL 35-BM		
Front plates:						
Cross wiper for front plate (spare part)	QAS 15-STB	QAS 20-STB	QAS 25-STB	QAS 35-STB		
Corrosion resistant grease nipples:						
Hydraulic-type grease nipple straight M3	SN 3	SN 3	-	-		
Hydraulic-type grease nipple straight M6	-	SN 6-V2A	SN 6-V2A	SN 6-V2A		
Hydraulic-type grease nipple 45°	-	SN 6-45-V2A	SN 6-45-V2A	SN 6-45-V2A		
Hydraulic-type grease nipple 90°	-	SN 6-90-V2A	SN 6-90-V2A	SN 6-90-V2A		
Flush type grease nipple M3 45°	SN 3-T-45	SN 3-T-45	-	-		
Grease gun for SN 3-T und SN 6-T	SFP-T3	SFP-T3	SFP-T3	SFP-T3		
Corrosion resistant grease adapters:						
Straight screw-in connection M3	SA 3-D3	SA 3-D3	-	-		
Straight screw-in connection M6	-	SA 6-D4	SA 6-D4	SA 6-D4		
Lubrication adapter M8 hexagon head long	-	SA 6-6KT-M8x1-L	SA 6-6KT-M8x1-L	SA 6-6KT-M8x1-L		
Swivel screw connection for pipe d=3 mm	SV 3-D3	SV 3-D3	-	-		
Swivel screw connection for pipe d=4 mm	-	SV 6-D4	SV 6-D4	SV 6-D4		
Swivel screw connection M8	-	SV 6-M8x1	SV 6-M8x1	SV 6-M8x1		

Other lubrication systems upon request

5.4 Order key

Individual guide rails and carriages are ordered in accordance with the order codes described below.

Q.v. chapter 2.1 and chapter 5.3 for the order key for accessories.

Separate order codes are used in each case for rails, carriages and accessories. This also applies to different versions of rails and carriages.

All guide components are supplied individually as standard, i.e. unassembled.

If required, SCHNEEBERGER can also supply rails and carriages assembled incl. accessories as complete systems. Please note the ordering instructions in chapter 2.4 if this applies.

Order code for BM SR Rails

	2x	BM SR	25	-N	-G3	-KC	-R1	-958	-29	-29	-CN
Quantity											
Rail											
Size											
Type											
Accuracy											
Straightness											
Reference side											
Rail length L3											
Position of first fixing hole L5											
Position of last fixing hole L10											
Coating											

NB

Q.v. chapter 5.1 to 5.3 for an overview of types, details of shapes, available options and accessories.

Q.v. chapter 2 for a description of the options.

If possible, standard lengths are preferred for L3 rail length.

These are calculated with the table values in chapter 5.2 using the following formula: $L3 = n \times L4 + L5 + L10 \leq L3_{max}$.

Order code for BM WR Carriages

	4x	BM WR	25	-A	-G3	-V1	-R1	-CN	-S99	-LN
Quantity										
Carriage										
Size										
Type										
Accuracy										
Preload										
Reference side										
Coating										
Lube connection										
Lubrication as delivered condition										

NB

Q.v. chapter 5.1 to 5.3 for an overview of types, details of shapes, available options and accessories.

Q.v. chapter 2 for a description of the options.

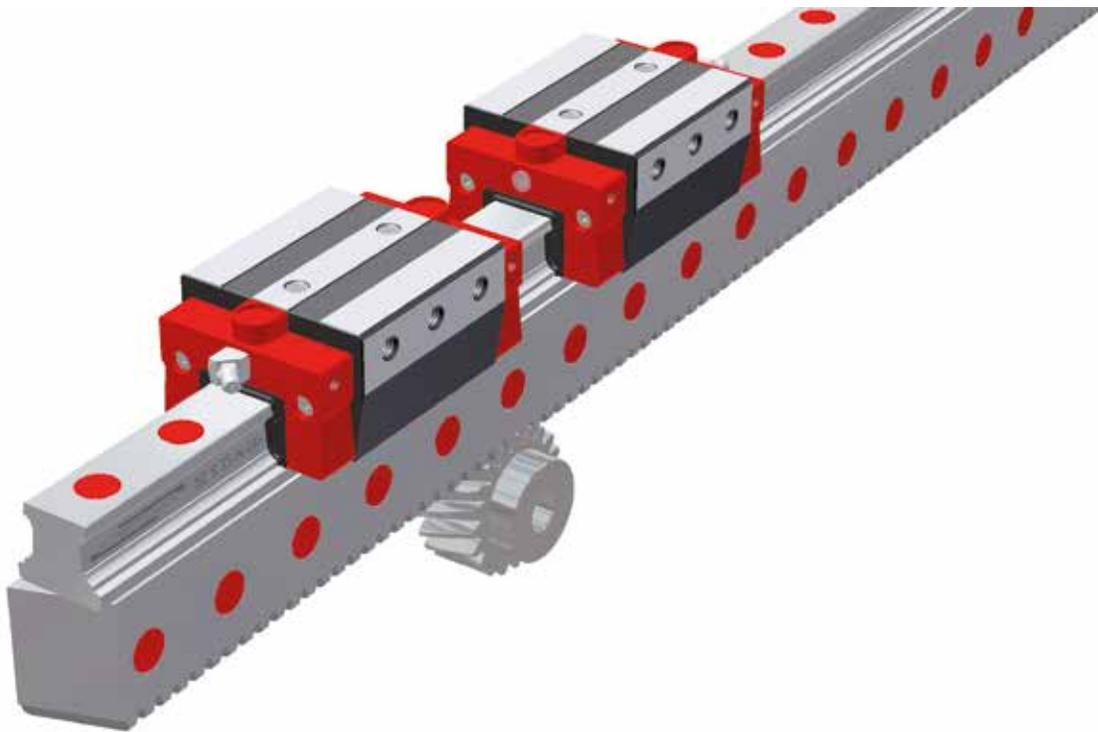

With its BZ MONORAIL, SCHNEEBERGER offers linear guide systems that extend the characteristic properties of the company's BM MONORAIL profile rail guides to include the advantages of an integral and high-precision rack drive.

Customers gain the following decisive benefits:

- One-piece system up to 6000 mm long
- High-quality gear rack (hardened and ground)
- Cost savings of up to 25% due to reduced outlay on manufacturing and assembly
- Superlative operating properties, high load carrying capacity and a long service life based on our proven MONORAIL linear guides
- Oriented towards customer requirements due to the large number of carriage types available with BM ball guides and a comprehensive range of accessories and customised gear types and grades.

Features of System MONORAIL BZ

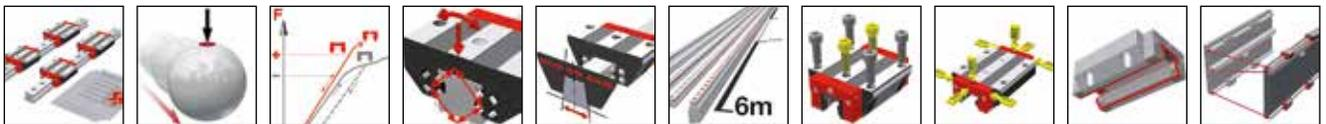

Details see chapter 1

6.1 Overview of types, sizes and available options

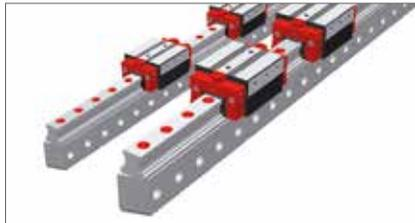

Product overview BZ Rails	Page 104
Product overview BM Carriages	Page 105

6.2 Technical data and options

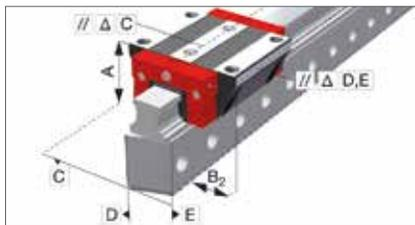

BZ Size 25	Page 106
BZ Size 35	Page 108

6.3 Accessories MONORAIL BZ



Accessories overview	Page 110
BZ Rails accessory details	Page 111
BM Carriages accessory details	Page 81

6.4 Order key



Order code for BZ Rails	Page 114
Order code for BM Carriages	Page 114

6.1 Overview of types, sizes and available options BZ Rails

Product overview BZ Rails



NX
standard, half pitch

Buildsizes / Rail build forms

Size 25	BZ S 25-NX			
Size 35	BZ S 35-NX			

Features

Screwable from the side	●			
Good accessibility of the fixing screws	●			
Great single-part system length	●			

Available options for BZ Rails

Details see chapter 2

Toothing quality

-  Q6, smooth, milled
-  Q5, hard, ground

Reference side

-  R1 Ref. at bottom
-  R2 Ref. on top

Coating

-  CN None
-  CH Hard chromium

Available accessories for MR Rails

Plugs

Pinions

Others

6.1 Overview of types, sizes and available options BZ Carriages

Product overview BM Carriages

							
	A standard	B standard, long	C compact, high	D compact, high, long	E compact, high, for lateral fixation	F compact	G compact, long
Buildsizes / Carriage build forms							
Size 25	BM W 25-A	BM W 25-B	BM W 25-C	BM W 25-D	BM W 25-E	BM W 25-F	BM W 25-G
Size 35	BM W 35-A	BM W 35-B	BM W 35-C	BM W 35-D	BM W 35-E	BM W 35-F	BM W 35-G
Features							
Screwable from above	●	●	●	●		●	●
Screwable from below	●	●					
Screwable from the side					●		
For high loads and moments		●		●			●
For medium loads and moments	●		●		●	●	
For limited installation space						●	●

Available options for BM Carriages

Details see chapter 2

Accuracy

-  **G0** Highly accurate
-  **G1** Very accurate
-  **G2** Accurate
-  **G3** Standard

Preload

-  **V0** Very low
-  **V1** Low
-  **V2** Medium
-  **V3** High

Reference side

-  **R1** Ref. at bottom
-  **R2** Ref. on top

Coating

-  **CN** None
-  **CH** Hard chromium

Lube connections

-  **S10** Left center
-  **S20** Right center
-  **S11** Top left
-  **S21** Top right
-  **S12** Lower left side
-  **S22** Lower right side

-  **S13** Upper left side
-  **S23** Upper right side
-  **S32** Left side
-  **S42** Right side

Lubrication

-  **LN** Oil protect
-  **LG** Grease protect
-  **LV** Full greasing

Available accessories for MR Carriages

Details see chapter 4.3 und 2.1

Additional wipers
Front plates

Bellows
Lube nipples

Assembly rails
Lube adapters

Lubrication plates

BZ S 25 Drawings

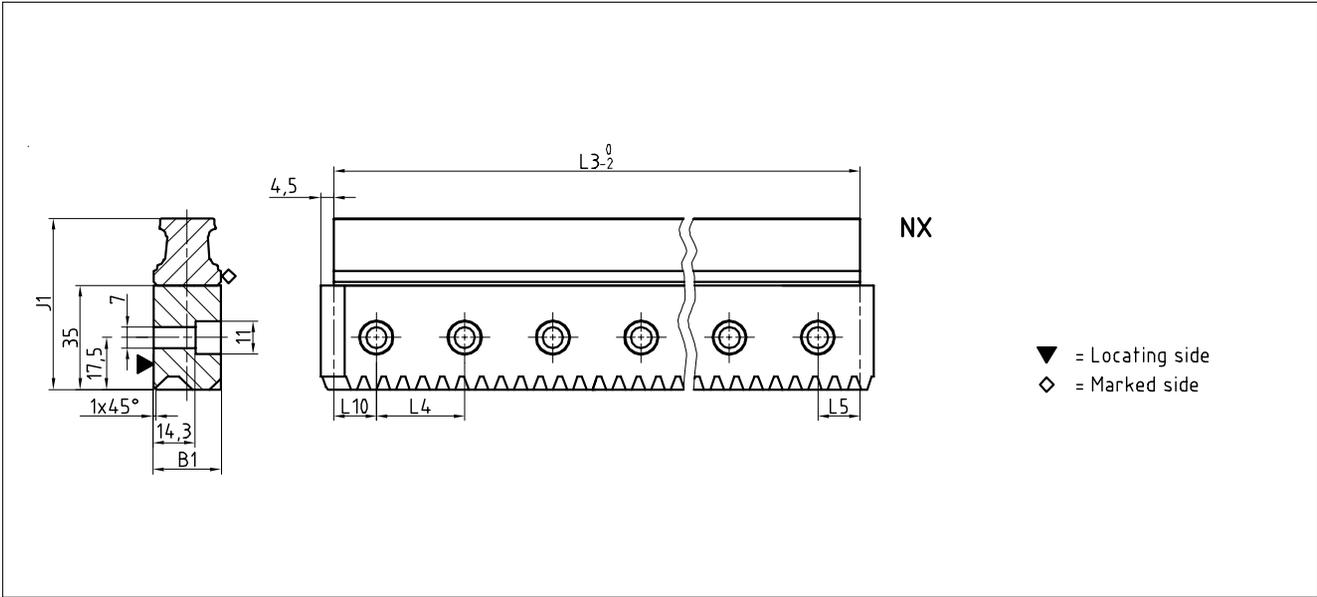

BM W 25 Drawings – BZ

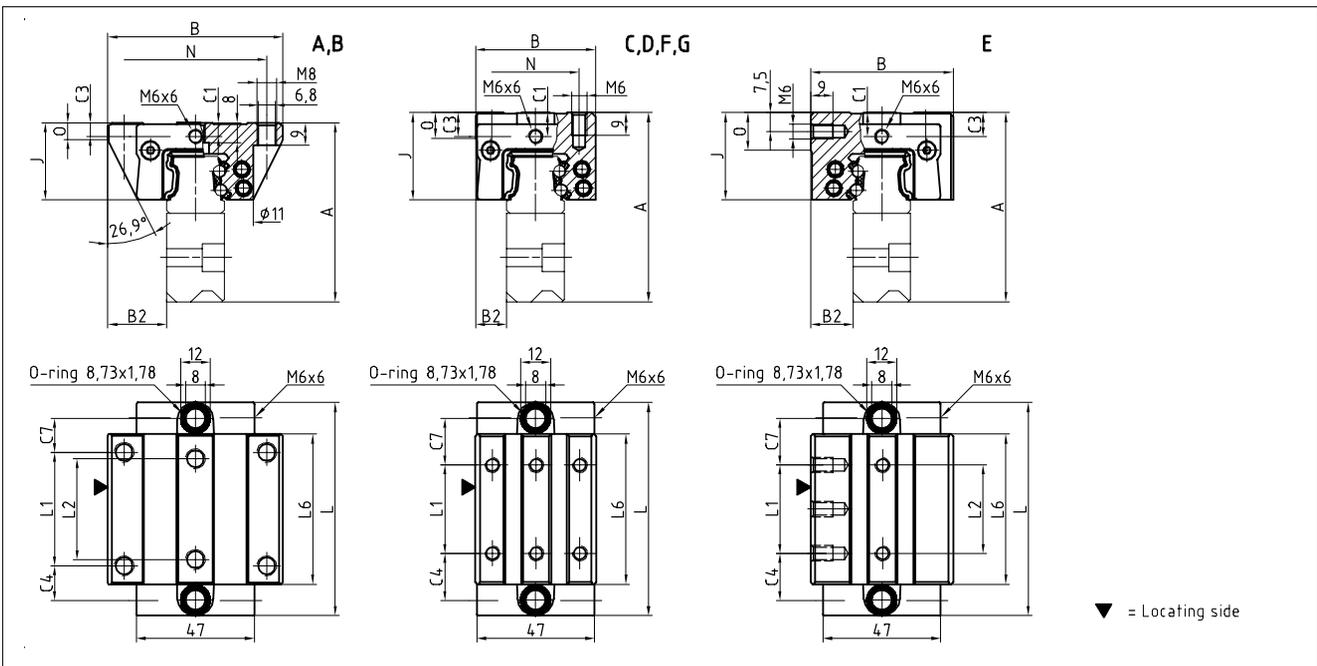

BM W 25 Rigidity diagram

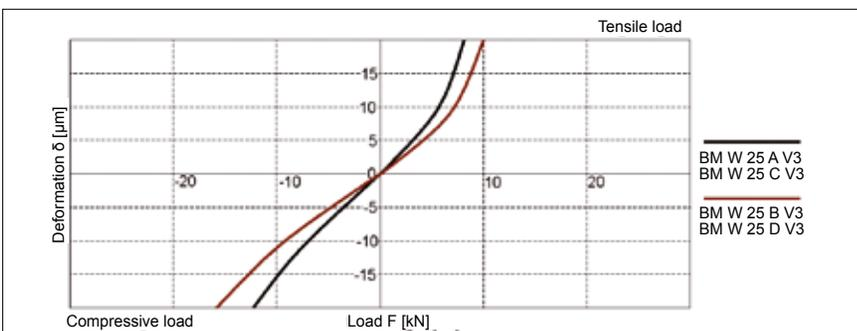

BM W 25 Load rating

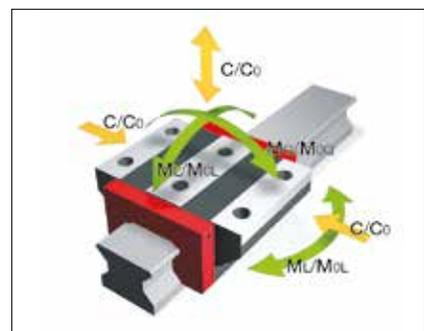

6.2 Technical data and options

BZ Size 25

BZ S 25 Dimensions



		BZ S 25-NX				
B1:	Rail width	23				
J1:	Rail height	57.7				
L3:	Rail length max.	6000				
L4:	Spacing of fixing holes	30				
L5/L10:	Position of first/last fixing hole	15				
m:	Modul	2				
α:	Helix angle	19°31'42"				
Gew.:	Rail weight, specific (kg/m)	8.9				

Available options for BZ S 25



BM W 25 Dimensions and capacities



	BM W 25-A	BM W 25-B	BM W 25-C	BM W 25-D	BM W 25-E	BM W 25-F	BM W 25-G
A:	System height	71	71	75	75	75	71
B:	Carriage width	70	70	48	48	57	48
B2:	Distance between locating faces	23.5	23.5	12.5	12.5	17	12.5
C1:	Position of center front lube hole	5.5	5.5	9.5	9.5	9.5	5.5
C3:	Position of lateral lube hole	5.5	5.5	9.5	9.5	9.5	5.5
C4:	Position of lateral lube hole	13.75	23.25	18.75	20.75	18.75	20.75
C7:	Position of top lube hole	13.5	23	18.5	20.5	18.5	20.5
J:	Carriage height	30.5	30.5	34.5	34.5	34.5	30.5
L:	Carriage length	84.5	103.5	84.5	103.5	84.5	103.5
L1:	Exterior fixing hole spacing	45	45	35	50	35	50
L2:	Interior fixing hole spacing	40	40	-	-	35	-
L6:	Steel body length	59.5	78.5	59.5	78.5	59.5	78.5
N:	Lateral fixing hole spacing	57	57	35	35	-	35
O:	Reference face height	7	7	11	11	15	7.1
Capacities and weights							
C0:	Static load capacity (N)	46100	60300	46100	60300	46100	60300
C100:	Dynamic load capacity (N)	21100	25500	21100	25500	21100	25500
MOQ:	Static cross moment capacity (Nm)	631	825	631	825	631	825
MOL:	Static longitud. moment capacity (Nm)	513	836	513	863	513	863
MQ:	Dyn. cross moment capacity (Nm)	289	349	289	349	289	349
ML:	Dyn. longitud. moment capacity (Nm)	235	365	235	365	235	365
Gew:	Carriage weight (kg)	0.7	0.9	0.6	0.8	0.7	0.7

Available options for BM W 25



BZ S 35 Drawings

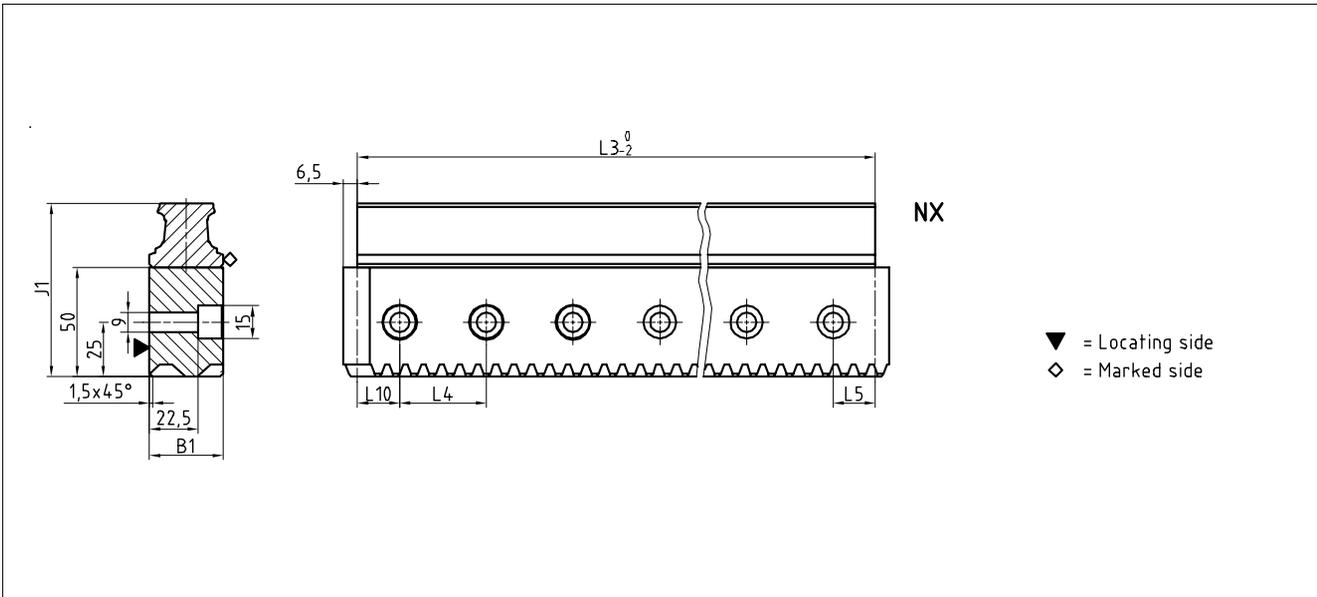

BM W 35 Drawings – BZ

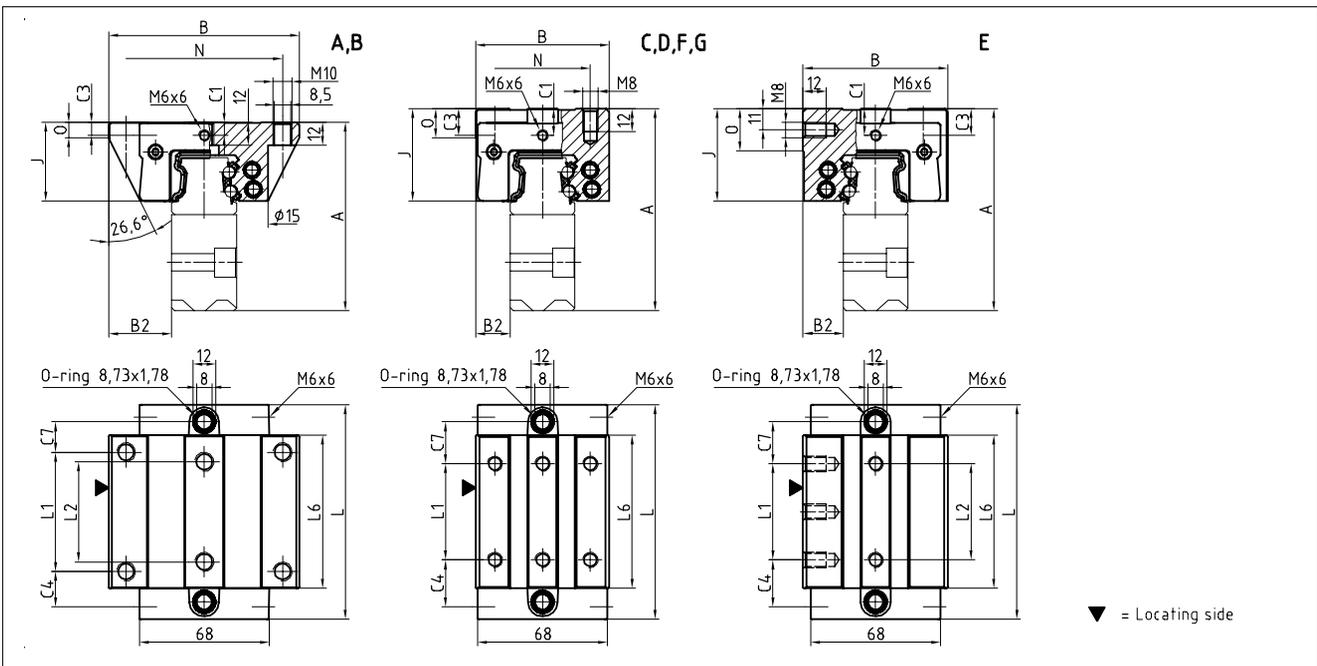

BM W 35 Rigidity diagram

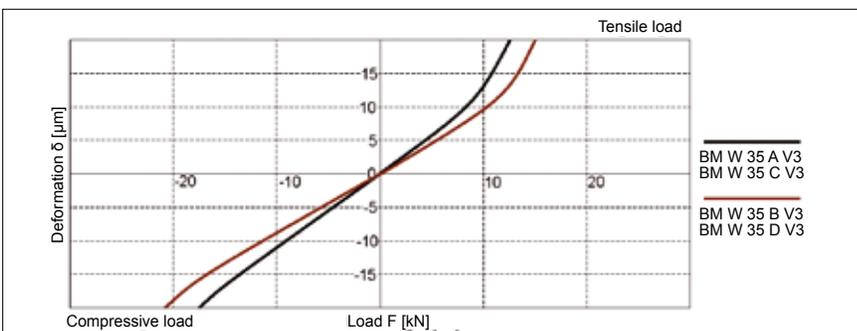

BM W 35 Load rating

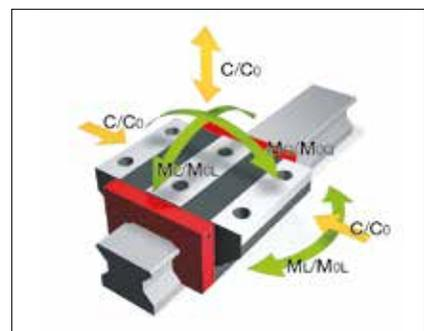

6.2 Technical data and options

BZ Size 35

BZ S 35 Dimensions



		BZ S 35-NX				
B1:	Rail width	34				
J1:	Rail height	79.5				
L3:	Rail length max.	6000				
L4:	Spacing of fixing holes	40				
L5/L10:	Position of first/last fixing hole	20				
m:	Modul	2.5				
α :	Helix angle	19°31'42"				
Gew.:	Rail weight, specific (kg/m)	17.9				

Available options for BZ S 35



BM W 35 Dimensions and capacities



	BM W 35-A	BM W 35-B	BM W 35-C	BM W 35-D	BM W 35-E	BM W 35-F	BM W 35-G
A:	System height	98	98	105	105	105	98
B:	Carriage width	100	100	70	70	76	70
B2:	Distance between locating faces	33	33	18	18	21	18
C1:	Position of center front lube hole	7	7	14	14	14	7
C3:	Position of lateral lube hole	7	7	14	14	14	7
C4:	Position of lateral lube hole	18.3	31.05	24.3	26.05	24.3	26.05
C7:	Position of top lube hole	15.8	28.55	21.8	23.55	21.8	23.55
J:	Carriage height	41	41	48	48	48	41
L:	Carriage length	111.6	137.1	111.6	137.1	111.6	137.1
L1:	Exterior fixing hole spacing	62	62	50	72	50	72
L2:	Interior fixing hole spacing	52	52	-	-	50	-
L6:	Steel body length	79.6	105.1	79.6	105.1	79.6	105.1
N:	Lateral fixing hole spacing	82	82	50	50	-	50
O:	Reference face height	8	8	15	15	22	8
Capacities and weights							
C0:	Static load capacity (N)	84400	110300	84400	110300	84400	110300
C100:	Dynamic load capacity (N)	38700	46700	38700	46700	38700	46700
MOQ:	Static cross moment capacity (Nm)	1566	2048	1566	2048	1566	2048
MOL:	Static longitud. moment capacity (Nm)	1252	2104	1252	2104	1252	2104
MQ:	Dyn. cross moment capacity (Nm)	718	867	718	867	718	867
ML:	Dyn. longitud. moment capacity (Nm)	574	891	574	891	574	891
Gew:	Carriage weight (kg)	1.8	2.3	1.7	2.2	1.9	1.8

Available options for BM W 35



BZ Rails accessories overview

Accessories	BZ S 25	BZ S 35			
Plugs:					
Plastic plugs	BRK 25	BRK 35			
Pinions:					
Pinion with through bore	BZR 25-...	BZR 35-...			
Pinion with through bore and keyway	BZR 25-...-K	BZR 35-...-K			
Pinion with shaft	BZR 25-S-...	BZR 35-S-...			
Pinion with shaft and keyway	BZR 25-S-...-K	BZR 35-S-...-K			
Others:					
Lubricating pinion	BZR 25-L-...-K	BZR 35-L-...			
Pinion hub for lubricating pinion	BZR 25-LN	BZR 35-LN			
Assembly fixture for BZ systems	BZM 25-.....	BZM 35-.....			

BM Carriages accessories overview

Accessories	BM W 25	BM W 35			
Additional wipers:					
Additional wipers NBR	ZBN 25	ZBN 35			
Additional wipers Viton	ZBV 25	ZBV 35			
Metal wiper	ABM 25	ABM 35			
Bellows:					
Bellows	FBB 25	FBB 35			
Adapter plate for bellows (spare part)	ZPB 25	ZPB 35			
End plate for bellows (spare part)	EPB 25	EPB 35			
Assembly rails:					
Assembly rail	MBM 25	MBM 35			
Lubrication plates:					
Lubrication plate	SPL 25-BM	SPL 35-BM			
Front plates:					
Cross wiper for front plate (spare part)	QAS 25-STB	QAS 35-STB			
Lube nipples:					
Hydraulic-type grease nipple straight	SN 6	SN 6			
Hydraulic-type grease nipple 45°	SN 6-45	SN 6-45			
Hydraulic-type grease nipple 90°	SN 6-90	SN 6-90			
Flush type grease nipple M3	-	-			
Flush type grease nipple M6	SN 6-T	SN 6-T			
Grease gun for SN 3-T und SN 6-T	SFP-T3	SFP-T3			
Lube adapters:					
Straight screw-in connection M3	-	-			
Lubrication adapter M8 round-head	SA 6-RD-M8	SA 6-RD-M8			
Lubrication adapter M8 hexagon head	-	SA 6-6KT-M8			
Lubrication adapter G1/8 hexagon head	-	SA 6-6KT-G1/8			
Swivel screw connection for pipe d=4 mm	SV 6-D4	SV 6-D4			
Swivel screw connection M6	SV 6-M6	SV 6-M6			
Swivel screw connection M6 long	SV 6-M6-L	SV 6-M6-L			
Swivel screw connection M8	SV 6-M8	SV 6-M8			
Swivel screw connection M8 long	SV 6-M8-L	SV 6-M8-L			

6.3 Accessories

BZ Rails accessory details

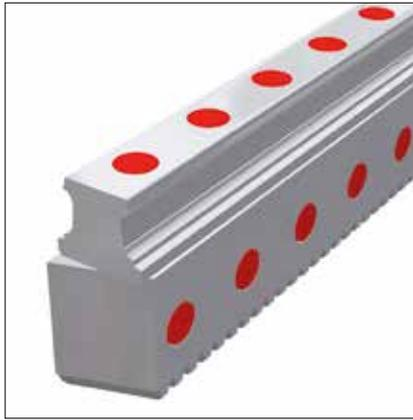

Plastic plugs

If required, the attachment holes on the sides of BZ rails can be closed with BRK plastic plugs. However, this is not essential as the holes are located outside the carriage's area of movement.

Scope of supply: Pack of 25 pcs

Order code: **BRK xx**

xx = Size, sample order: 3 x BRK 25 (75 pcs)

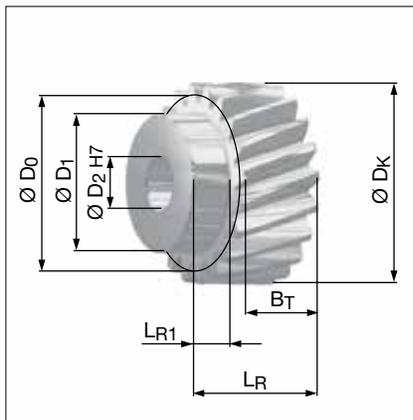

Pinion with through bore

The pinion has hardened and ground helical teeth in quality 6. The bore is soft and can be machined by customers to suit their individual requirements.

This pinion is also available with a keyway (see next paragraph).

For dimensions, please refer to the BZR xx columns in the table of dimensions.

Order code:

Size 25: **BZR 25-2.0-20-S6**

Size 35: **BZR 35-2.5-20-S6**

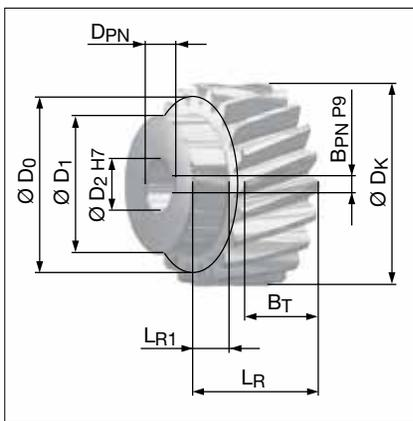

Pinion with through bore and keyway

This pinion is similar to the pinion with a through bore but also has a keyway to specification DIN 6885-A to facilitate its attachment to a drive shaft.

For dimensions, please refer to the BZR xx-K columns in the table of dimensions.

Order code:

Size 25: **BZR 25-2.0-20-S6-K**

Size 35: **BZR 35-2.5-20-S6-K**

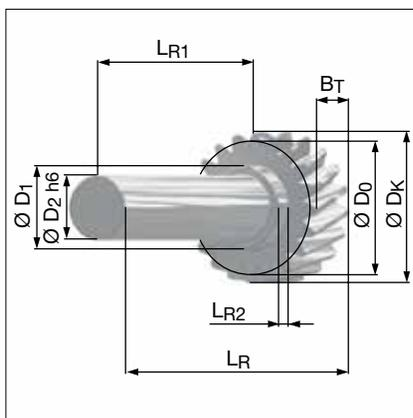

Pinion with shaft

This pinion with hardened and ground helical teeth in quality 6 has a plain shaft. This is left unhardened to permit subsequent machining.

This pinion is also available with a keyway (see next paragraph).

For dimensions, please refer to the BZR xx-S columns in the table of dimensions.

Order code:

Size 25: **BZR 25-S-2.0-20-S6**

Size 35: **BZR 35-S-2.5-20-S6**

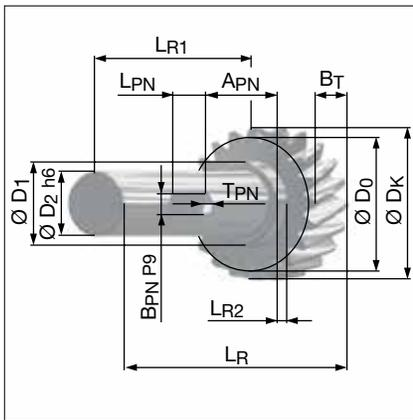

Pinion with shaft and keyway

This pinion is similar to the pinion with a shaft, but also has a keyway to specification DIN 6885-A for attachment.

For dimensions, please refer to the BZR xx-S-K columns in the table of dimensions.

Order code:

Size 25: **BZR 25-S-2.0-20-S6-K**

Size 35: **BZR 35-S-2.5-20-S6-K**

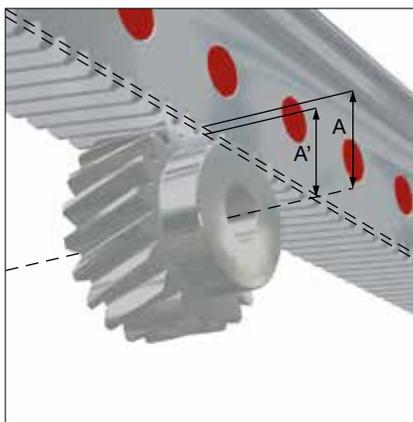

Measure A und A'

Dimension table pinions

	BZR 25	BZR 35	BZR 25-K	BZR 35-K	BZR 25-S	BZR 35-S	BZR 25-S-K	BZR 35-S-K
z: Number of teeth	20	20	20	20	20	20	20	20
m: Module	2.0	2.5	2.0	2.5	2.0	2.5	2.0	2.5
α : Helix angle	19°31'42"	19°31'42"	19°31'42"	19°31'42"	19°31'42"	19°31'42"	19°31'42"	19°31'42"
A: Distance axis - reference circle	21.22	26.53	21.22	26.53	21.22	26.53	21.22	26.53
A': Distance axis - tooth crest of rack	19.22	24.03	19.22	24.03	19.22	24.03	19.22	24.03
BT: Tooth width	20	25	20	25	20	25	20	25
DK: Outside diameter	46.44	58.05	46.44	58.05	46.44	58.05	46.44	58.05
D0: Reference diameter	42.44	53.05	42.44	53.05	42.44	53.05	42.44	53.05
D1: Shoulder diameter	35	40	35	40	32	32	32	32
D2: Bore / shaft diameter	15	15	15	15	25	25	25	25
LR: Total length	30	37	30	37	140	145	140	145
LR1: Shaft length	10	12	10	12	120	120	120	120
LR2: Shoulder length	-	-	-	-	8	8	8	8
APN: Keyway distance	-	-	-	-	-	-	43.5	43.5
BPN: Keyway width	-	-	5	5	-	-	8	8
DPN: Diameter of bore with keyway	-	-	17.3	17.3	-	-	-	-
LPN: Keyway length	-	-	-	-	-	-	25	25
TPN: Keyway depth	-	-	-	-	-	-	4	4

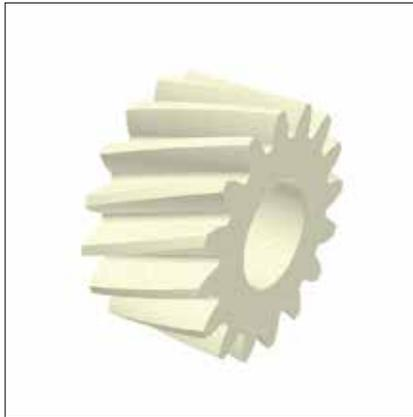

Lubricating pinion

Felt lubricating pinions are available to lubricate the racks. These can be supplied with oil either manually or with an automatic lubrication system.

Order code:

Size 25: **BZR 25-L-2.0-16-S**

Size 35: **BZR 35-L-2.5-16-S**



Pinion hub for lubricating pinion

Pinion hubs are used in combination with lubricating pinions. Lubricating oil can be fed through the hub to the felt pinion through via a special arrangement of lubricating channels.

Order code:

Size 25: **BZR 25-LN**

Size 35: **BZR 35-LN**

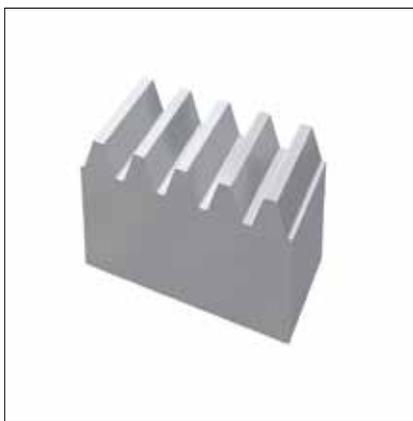

Assembly fixture for BZ systems

An assembly fixture is available for the alignment of butt-jointed BZ rails. It consists of a rack segment designed to match BZ teeth. During assembly, the segment is inserted into the racks on both sides of the butt joint which connects and aligns them precisely.

Order code:

Size 25: **BZM 25-2.0-7-S5**

Size 35: **BZM 35-2.5-6-S5**

6.4 Order key

Individual guide rails and carriages are ordered in accordance with the order codes described below.

All MONORAIL BM carriages can be used with BZ rails.

Q.v. chapter 2.1, chapter 4.3 and 6.3 for the order key for accessories.

Separate order codes are used in each case for rails, carriages and accessories. This also applies to different versions of rails and carriages.

All guide components are supplied individually as standard, i.e. unassembled.

If required, SCHNEEBERGER can also supply rails and carriages assembled incl. accessories as complete systems. Please note the ordering instructions in chapter 2.4 if this applies.

Order code for BZ Rails

	2x	BZ S	25	-Q6S	-R1	-960	-15	-15	-CN
Quantity									
Rail									
Size									
Toothing quality									
Reference side									
Rail length L3									
Position of first fixing hole L5									
Position of last fixing hole L10									
Coating									

NB

Q.v. chapter 6.1 to 6.3 for an overview of types, details of shapes, available options and accessories.

Q.v. chapter 2 for a description of the options.

If possible, standard lengths are preferred for L3 rail length.

These are calculated with the table values in chapter 6.2 using the following formula: $L3 = n \times L4 + L5 + L10 \leq L3max$.

Order code for BM Carriages

	4x	BM W	25	-A	-G3	-V1	-R1	-CN	-S10	-LN
Quantity										
Carriage										
Size										
Type										
Accuracy										
Preload										
Reference side										
Coating										
Lube connection										
Lubrication as delivered condition										

NB

Q.v. chapter 6.1 to 6.3 for an overview of types, details of shapes, available options and accessories.

Q.v. chapter 2 for a description of the options.

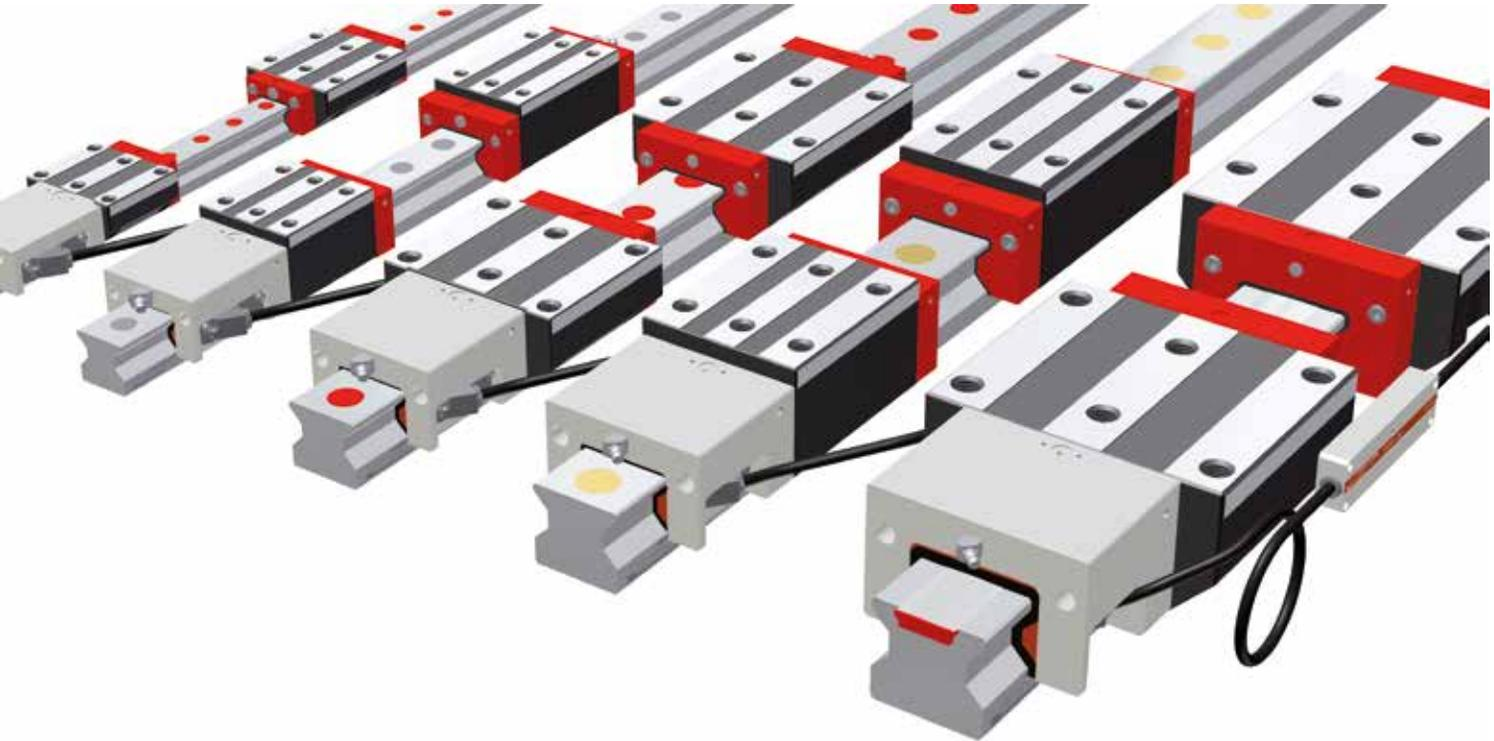

SCHNEEBERGER's MONORAIL AMS 3B is an integrated measuring system for distance measurement for use on all protected machine tool axes with high demands on system precision. Mechanically the AMS 3B is based on SCHNEEBERGER's MONORAIL MR roller guide with lengths up to 6 metres. The integration of the measurement system allows very compact axes to be put together.

A digital interface with a range of different resolutions for different maximum speeds, and an analog 1Vpp (200 µm signal period) interface are available as interfaces with the control system. Reference marks can be set at 50mm intervals or distance coded. Different options for carriage lubrication and sealing permit the best possible degree of adaptation to application requirements. The easily interchangeable reading head is identical for all sizes.

Features of System MONORAIL AMS 3B

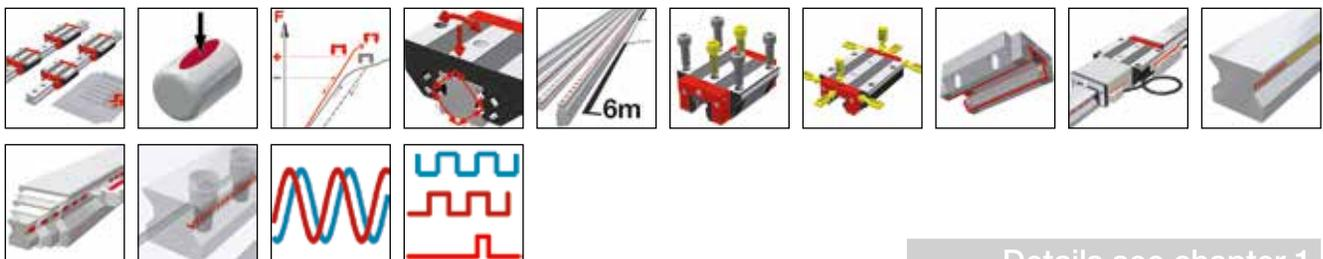

Details see chapter 1

7.1 Overview of types, sizes and available options



Product overview AMS 3B Rails	Page 118
Product overview AMS 3B Carriages	Page 119

7.2 Technical data and options

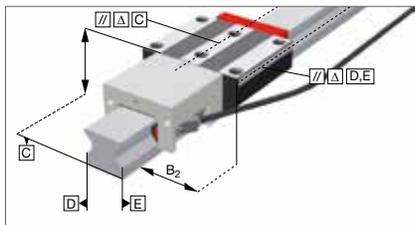

AMS 3B Size 25	Page 120
AMS 3B Size 35	Page 122
AMS 3B Size 45	Page 124
AMS 3B Size 55	Page 126
AMS 3B Size 65	Page 128

7.3 Accessories MONORAIL AMS 3B



Accessories overview	Page 130
AMS 3B Rails accessory details	Page 53
AMS 3B Carriages accessory details	Page 56

7.4 Order key



Order key Order key AMSA 3B Rails	Page 131
Order key AMSA 3B Carriages	Page 131
Order key AMSD 3B Rails	Page 132
Order key AMSD 3B Carriages	Page 132

Product overview AMS 3B Rails



N standard	NU with tapped holes at the bottom	C for cover strip
----------------------	---	-----------------------------

Buildsizes / Rail build forms

Size 25	AMS 3B S 25-N	AMS 3B S 25-NU	AMS 3B S 25-C
Size 35	AMS 3B S 35-N	AMS 3B S 35-NU	AMS 3B S 35-C
Size 45	AMS 3B S 45-N	AMS 3B S 45-NU	AMS 3B S 45-C
Size 55	AMS 3B S 55-N	AMS 3B S 55-NU	AMS 3B S 55-C
Size 65	AMS 3B S 65-N	AMS 3B S 65-NU	AMS 3B S 65-C

Features

Screwable from above	•		•
Screwable from below		•	
Small assembly effort		•	•
Great single-part system length	•	•	•

Available options for AMS 3B Rails

Details see chapter 2

Accuracy

- G0 Highly accurate
- G1 Very accurate
- G2 Accurate
- G3 Standard

Straightness

- KC Standard

Coating

- CN None
- CH Hard chromium

Locating sides

- R11 Ref.bottom, scale bottom
- R12 Ref.bottom, scale bottom
- R21 Ref.top, scale bottom
- R22 Ref.top, scale top

Magnetization

- TR50 50 mm pattern
- T020 20 mm code
- T050 50 mm code

Available accessories for AMS 3B Rails

Details see chapter 3.3

Plugs

Cover strips

Assembly tools

7.1 Overview of types, sizes and available options AMS 3B Carriages

Product overview AMS 3B Carriages

							
	A standard	B standard, long	C compact, high	D compact, high, long	E compact, high, for lateral fixing	F compact	G compact, long
Buildsizes / Carriage build forms							
Size 25	AMS 3B W 25-A	AMS 3B W 25-B	AMS 3B W 25-C	AMS 3B W 25-D	AMS 3B W 25-E	AMS 3B W 25-F	AMS 3B W 25-G
Size 35	AMS 3B W 35-A	AMS 3B W 35-B	AMS 3B W 35-C	AMS 3B W 35-D	AMS 3B W 35-E		
Size 45	AMS 3B W 45-A	AMS 3B W 45-B	AMS 3B W 45-C	AMS 3B W 45-D		AMS 3B W 45-F	
Size 55	AMS 3B W 55-A	AMS 3B W 55-B	AMS 3B W 55-C	AMS 3B W 55-D			AMS 3B W 55-G
Size 65	AMS 3B W 65-A	AMS 3B W 65-B	AMS 3B W 65-C	AMS 3B W 65-D			
Features							
Screwable from above	•	•	•	•		•	•
Screwable from below	•	•					
Screwable from the side					•		
For high loads and moments		•		•			•
For medium loads and moments	•		•		•	•	
For limited installation space						•	•

Available options for AMS 3B Carriages

Details see chapter 2

Accuracy

-  **G0** Highly accurate
-  **G1** Very accurate
-  **G2** Accurate
-  **G3** Standard

Preload

-  **V1** Low
-  **V2** Medium
-  **V3** High

Reference side

-  **R1** Ref. at bottom
-  **R2** Ref. on top

Coating

-  **CN** None
-  **CH** Hard chromium

Lube connections

-  **S10** Left center
-  **S20** Right center
-  **S11** Top left
-  **S21** Top right
-  **S12** Lower left side
-  **S22** Lower right side

-  **S13** Upper left side
-  **S23** Upper right side
-  **S32** Left side
-  **S42** Right side

Lubrication

-  **LN** Oil protect
-  **LG** Grease protect
-  **LV** Full greasing

Interface

-  **TMU** TMU, analog, 0.3m
-  **TRU** TRU, analog, 3m
-  **TSU** TSU, analog, 3m
-  **TMD** TMD, digital, 0.3m
-  **TRD** TRD, digital, 3m
-  **TSD** TSD, digital, 3m

Reading head position

-  **P1** Right top
-  **P3** Left bottom

Available accessories for AMS 3B Carriages

Details see chapter 2.1 and 3.3

- | | | | |
|-------------------|--------------|----------------|--------------------|
| Additional wipers | Bellows | Assembly rails | Lubrication plates |
| Front plates | Lube nipples | Lube adapters | Cables |

7.2 Technical data and options

AMS 3B Size 25

AMS 3B S 25 Dimensions

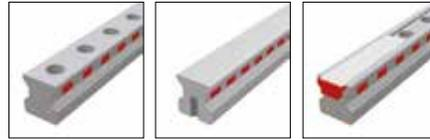

	AMS 3B S 25-N	AMS 3B S 25-NU	AMS 3B S 25-C			
B1: Rail width	23	23	23			
J1: Rail height	24.5	24.5	24.5			
L3: Rail length max.	6000	6000	3000			
L4: Spacing of fixing holes	30	30	30			
L5/L10: Position of first/last fixing hole	13.5	13,5	13.5			
Gew.: Rail weight, specific (kg/m)	3.4	3.8	3.3			

Available options for AMS 3B S 25



AMS 3B W 25 Dimensions and capacities



	AMS 3B W 25-A	AMS 3B W 25-B	AMS 3B W 25-C	AMS 3B W 25-D	AMS 3B W 25-E	AMS 3B W 25-F	AMS 3B W 25-G
A: System height	36	36	40	40	40	36	36
A1: Half width of housing on opposite side	23.5	23.5	23.5	23.5	23.5	23.5	23.5
A2: Half width of housing on reading head side	31	31	31	31	31	31	31
A3: Projection of reading head	11.5	11.5	11.5	11.5	11.5	11.5	11.5
B: Carriage width	70	70	48	48	57	48	48
B2: Distance between locating faces	23.5	23.5	12.5	12.5	17	12.5	12.5
C1: Position of center front lube hole*	5 / 5.5	5 / 5.5	9 / 9.5	9 / 9.5	9 / 9.5	5 / 5.5	5 / 5.5
C3: Position of lateral lube hole	-	-	-	-	-	-	-
C4: Position of lateral lube hole	-	-	-	-	-	-	-
C7: Position of top lube hole	12	23.2	17	20.7	17	17	17
J: Carriage height	29.5	29.5	33.5	33.5	33.5	29.5	29.5
L1: Exterior fixing hole spacing	45	45	35	50	35	35	50
L2: Interior fixing hole spacing	40	40	-	-	35	-	-
L9: Carriage length with housing	144.2	166.6	144.2	166.6	144.2	144.2	166.6
L11: Housing length	75.2	75.2	75.2	75.2	75.2	75.2	75.2
Lw: Inner carriage body length	57	79.4	57	79.4	57	57	79.4
N: Lateral fixing hole spacing	57	57	35	35	-	35	35
O: Reference face height	7.5	7.5	7.5	7.5	15	7.5	7.5
Ts: Front plate thickness	12	12	12	12	12	12	12
Capacities and weights							
C0: Static load capacity (N)	49800	70300	49800	70300	49800	49800	70300
C100: Dynamic load capacity (N)	27700	39100	27700	39100	27700	27700	39100
MOQ: Static cross moment capacity (Nm)	733	1035	733	1035	733	733	1035
MOL: Static longitud. moment capacity (Nm)	476	936	476	936	476	476	936
MQ: Dyn. cross moment capacity (Nm)	408	576	408	576	408	408	578
ML: Dyn. longitud. moment capacity (Nm)	265	521	265	521	265	265	521
Gew: Carriage weight (kg)	1.3	1.5	1.2	1.3	1.3	1.1	1.2

Note: * Values valid for external housing / front plate

Available options for AMS 3B W 25



AMS 3B S 35 Drawings

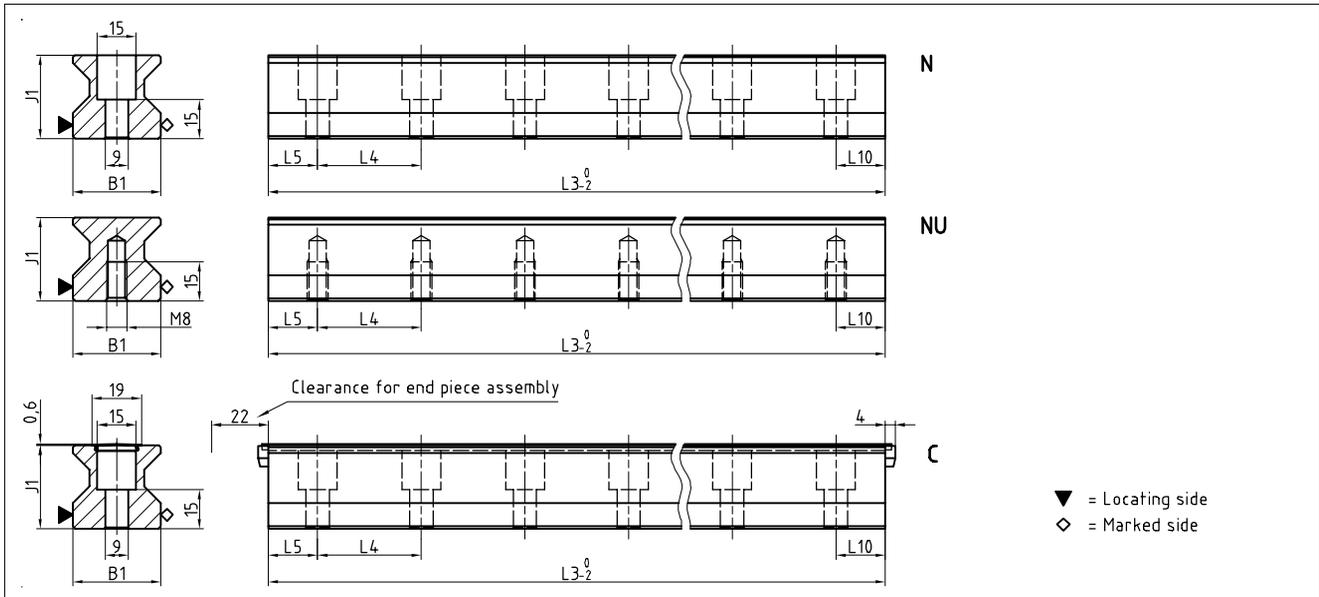

AMS 3B W 35 Drawings

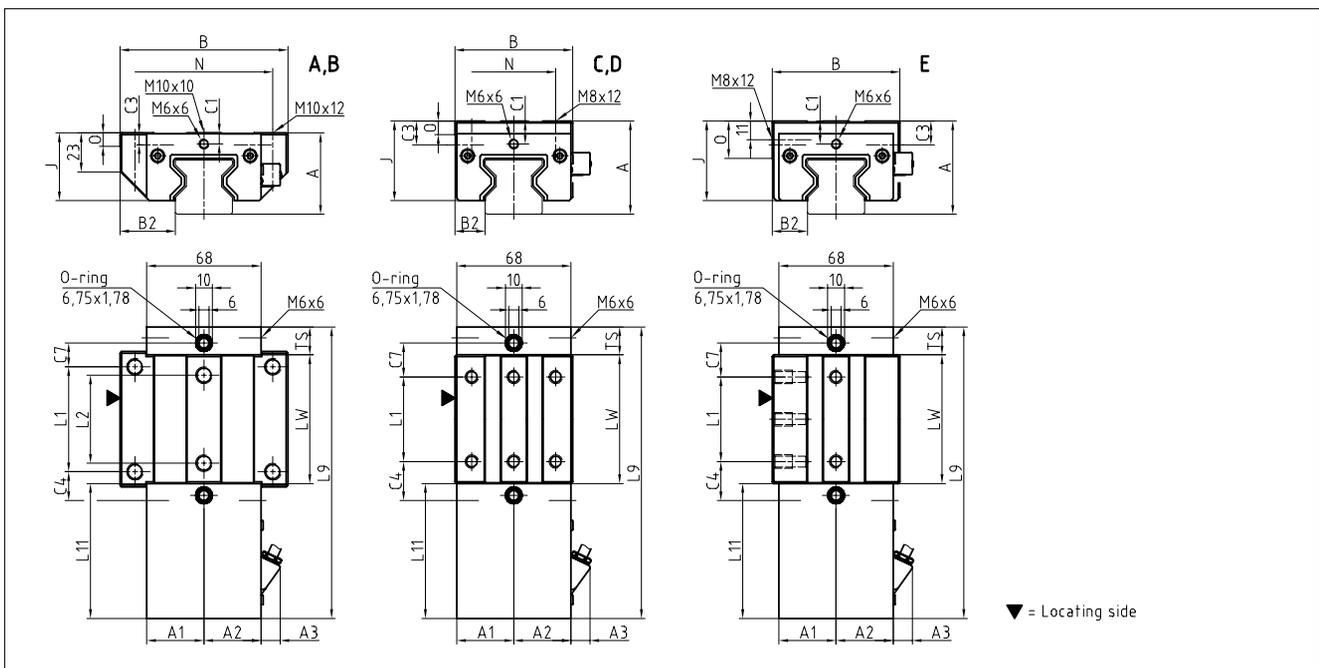

AMS 3B W 35 Rigidity diagram

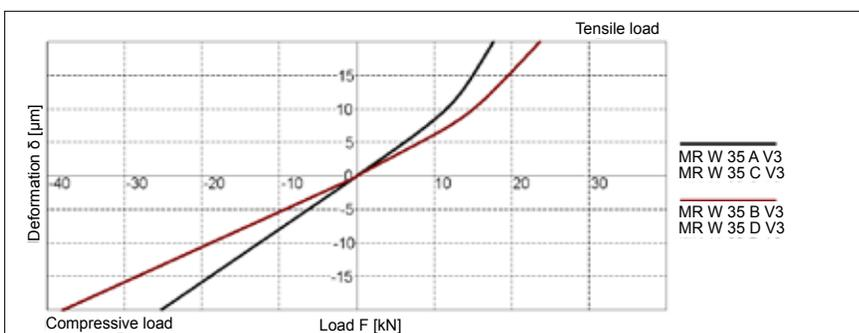

AMS 3B W 35 Load rating

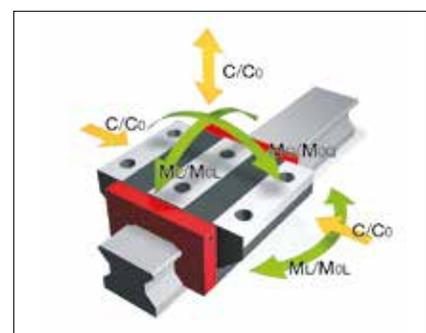

7.2 Technical data and options

AMS 3B Size 35

AMS 3B S 35 Dimensions



	AMS 3B S 35-N	AMS 3B S 35-NU	AMS 3B S 35-C			
B1: Rail width	34	34	34			
J1: Rail height	32	32	32			
L3: Rail length max.	6000	6000	6000			
L4: Spacing of fixing holes	40	40	40			
L5/L10: Position of first/last fixing hole	18.5	18.5	18.5			
Gew.: Rail weight, specific (kg/m)	6.5	7.1	6.3			

Available options for AMS 3B S 35



AMS 3B W 35 Dimensions and capacities



	AMS 3B W 35-A	AMS 3B W 35-B	AMS 3B W 35-C	AMS 3B W 35-D	AMS 3B W 35-E	
A: System height	48	48	55	55	55	
A1: Half width of housing on opposite side	34	34	34	34	34	
A2: Half width of housing on reading head side	34	34	34	34	34	
A3: Projection of reading head	11.5	11.5	11.5	11.5	11.5	
B: Carriage width	100	100	70	70	76	
B2: Distance between locating faces	33	33	18	18	21	
C1: Position of center front lube hole*	6.5 / 7	6.5 / 7	13.5 / 14	13.5 / 14	13.5 / 14	
C3: Position of lateral lube hole	7	7	14	14	14	
C4: Position of lateral lube hole	17	30.5	23	25.5	23	
C7: Position of top lube hole	14	27.5	20	22.5	20	
J: Carriage height	40	40	47	47	47	
L1: Exterior fixing hole spacing	62	62	50	72	50	
L2: Interior fixing hole spacing	52	52	-	-	50	
L9: Carriage length with housing	172.2	199.2	172.2	199.2	172.2	
L11: Housing length	79.7	79.7	79.7	79.7	79.7	
Lw: Inner carriage body length	76	103	76	103	76	
N: Lateral fixing hole spacing	82	82	50	50	-	
O: Reference face height	8	8	8	8	22	
Ts: Front plate thickness	16.5	16.5	16.5	16.5	16.5	
Capacities and weights						
C0: Static load capacity (N)	93400	128500	93400	128500	93400	
C100: Dynamic load capacity (N)	52000	71500	52000	71500	52000	
MOQ: Static cross moment capacity (Nm)	2008	2762	2008	2762	2008	
MOL: Static longitud. moment capacity (Nm)	1189	2214	1189	2214	1189	
MQ: Dyn. cross moment capacity (Nm)	1118	1537	1118	1537	1118	
ML: Dyn. longitud. moment capacity (Nm)	662	1232	662	1232	662	
Gew: Carriage weight (kg)	2.3	2.9	2.2	2.7	2.3	

Note: * Values valid for external housing / front plate

Available options for AMS 3B W 35

AMS 3B S 45 Drawings

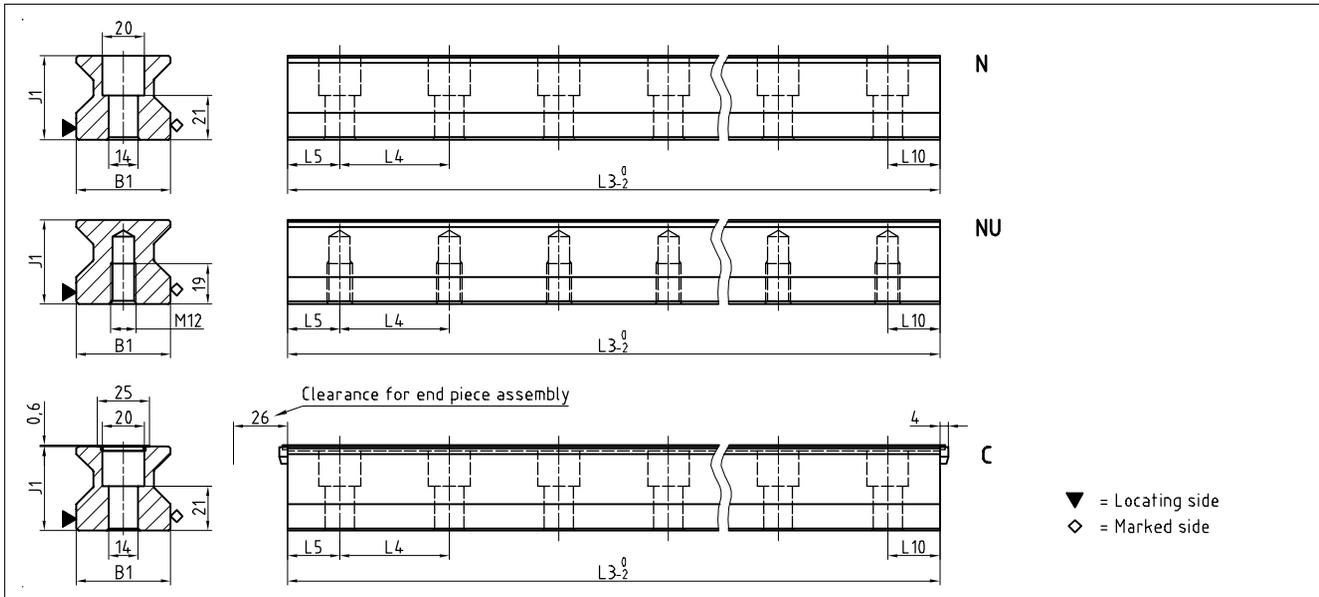

AMS 3B W 45 Drawings

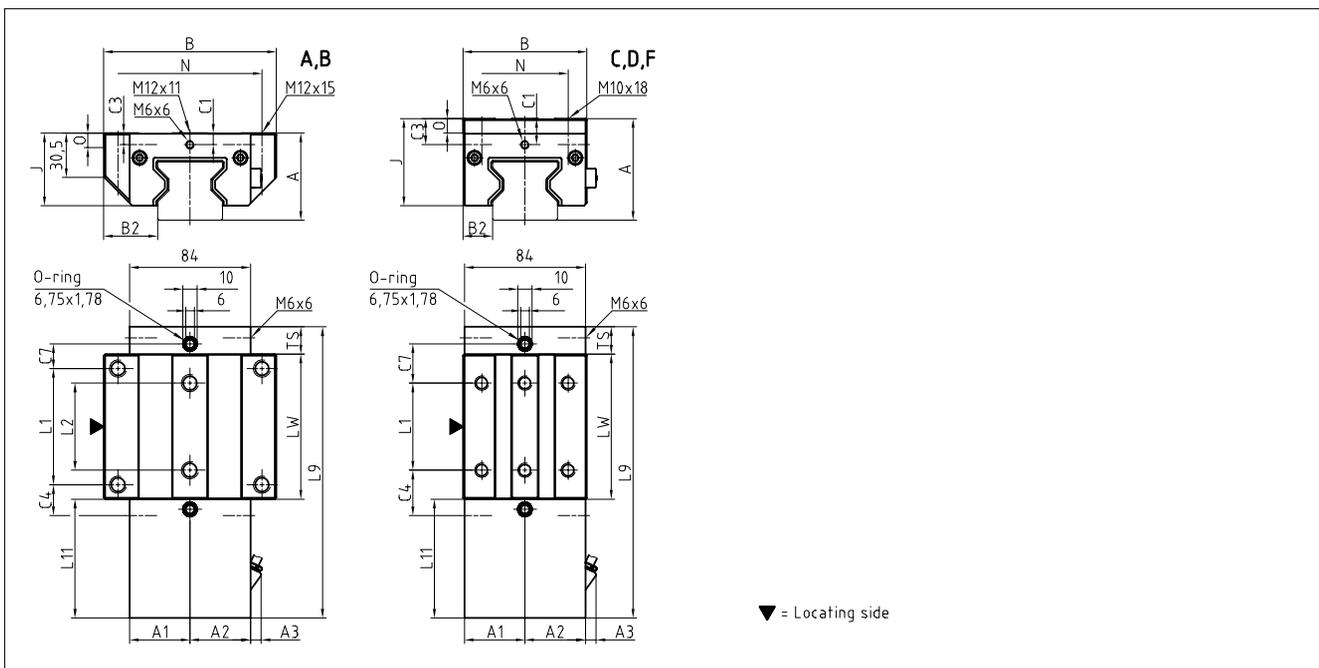

AMS 3B W 45 Rigidity diagram

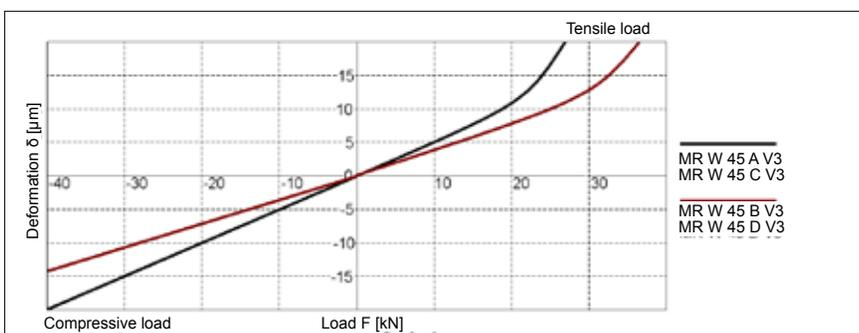

AMS 3B W 45 Load rating

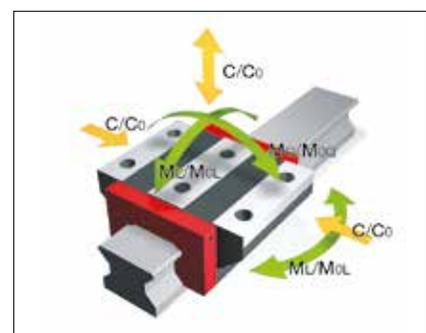

7.2 Technical data and options

AMS 3B Size 45

AMS 3B S 45 Dimensions



	AMS 3B S 45-N	AMS 3B S 45-NU	AMS 3B S 45-C			
B1: Rail width	45	45	45			
J1: Rail height	40	40	40			
L3: Rail length max.	6000	6000	6000			
L4: Spacing of fixing holes	52.5	52.5	52.5			
L5/L10: Position of first/last fixing hole	25	25	25			
Gew.: Rail weight, specific (kg/m)	10.8	11.8	10.8			

Available options for AMS 3B S 45



AMS 3B W 45 Dimensions and capacities

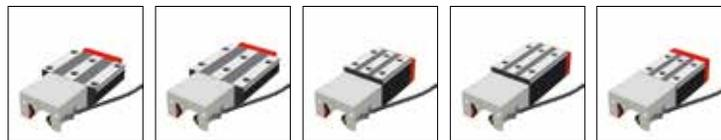

	AMS 3B W 45-A	AMS 3B W 45-B	AMS 3B W 45-C	AMS 3B W 45-D	AMS 3B W 45-F	
A: System height	60	60	70	70	60	
A1: Half width of housing on opposite side	42	42	42	42	42	
A2: Half width of housing on reading head side	42	42	42	42	42	
A3: Projection of reading head	7.5	7.5	7.5	7.5	7.5	
B: Carriage width	120	120	86	86	86	
B2: Distance between locating faces	37.5	37.5	20.5	20.5	20.5	
C1: Position of center front lube hole	8	8	18	18	8	
C3: Position of lateral lube hole	8	8	18	18	8	
C4: Position of lateral lube hole	21.25	38.75	31.25	38.75	31.25	
C7: Position of top lube hole	17	34.5	27	34.5	27	
J: Carriage height	50	50	60	60	50	
L1: Exterior fixing hole spacing	80	80	60	80	60	
L2: Interior fixing hole spacing	60	60	-	-	-	
L9: Carriage length with housing	200.7	235.7	200.7	235.7	200.7	
L11: Housing length	81.9	81.9	81.9	81.9	81.9	
Lw: Inner carriage body length	100	135	100	135	100	
N: Lateral fixing hole spacing	100	100	60	60	60	
O: Reference face height	10	10	10	10	10	
Ts: Front plate thickness	18.8	18.8	18.8	18.8	18.8	
Capacities and weights						
C0: Static load capacity (N)	167500	229500	167500	229500	167500	
C100: Dynamic load capacity (N)	93400	127800	93400	127800	93400	
MOQ: Static cross moment capacity (Nm)	4621	6333	4621	6333	4621	
MOL: Static longitud. moment capacity (Nm)	2790	5161	2790	5161	2790	
MQ: Dyn. cross moment capacity (Nm)	2577	3527	2577	3527	2577	
ML: Dyn. longitud. moment capacity (Nm)	1556	2874	1556	2874	1556	
Gew: Carriage weight (kg)	4.0	5.1	3.8	4.8	3.1	

Available options for AMS 3B W 45



AMS 3B S 55 Drawings

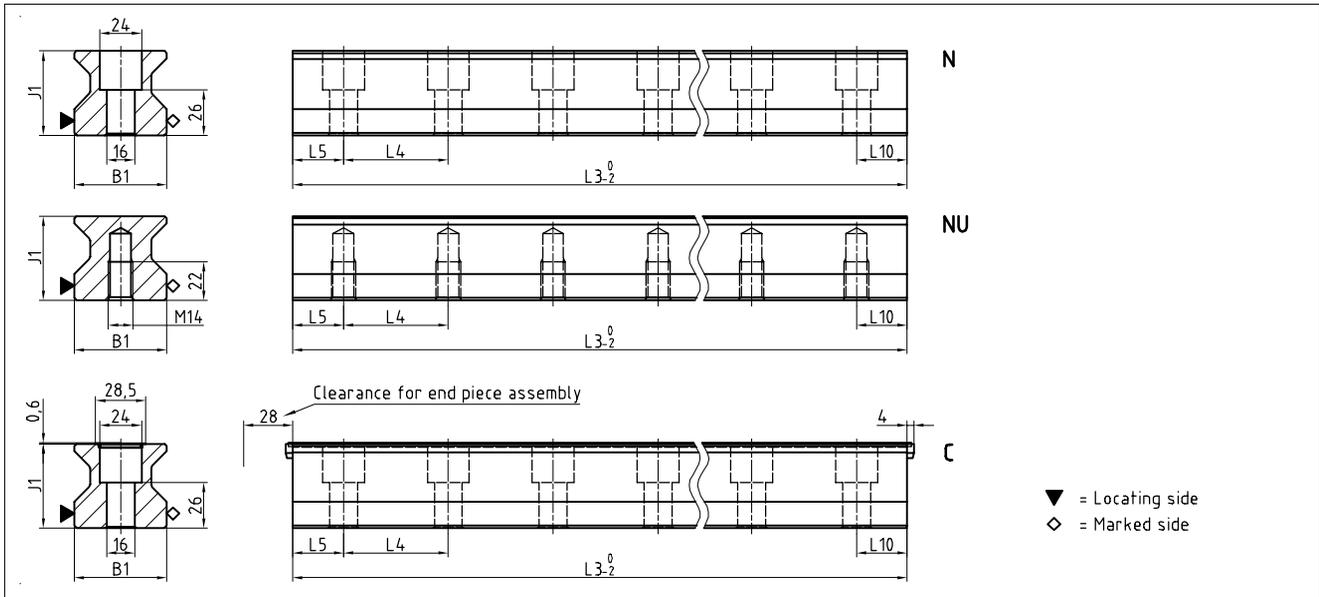

AMS 3B W 55 Drawings

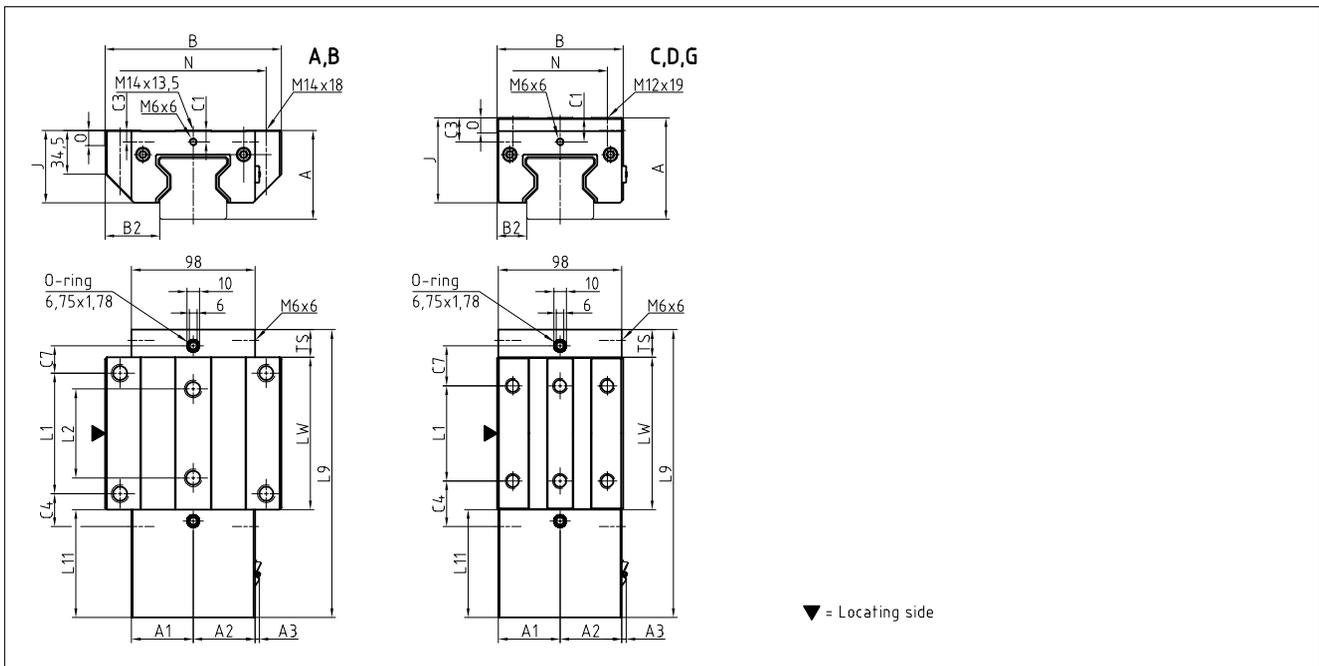

AMS 3B W 55 Rigidity diagram

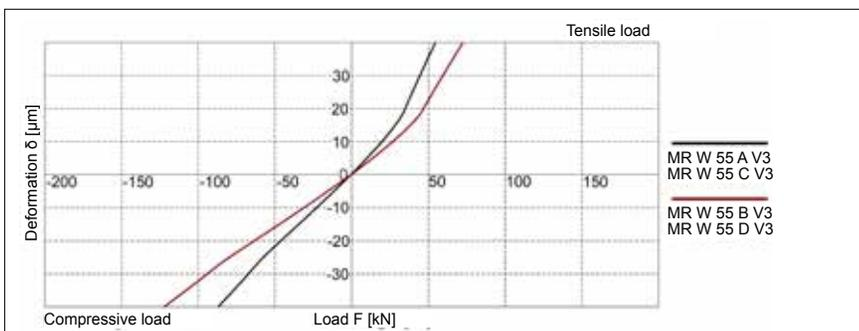

AMS 3B W 55 Load rating

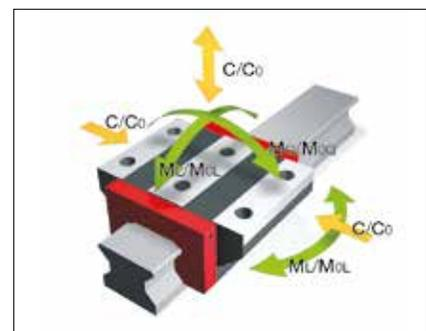

7.2 Technical data and options

AMS 3B Size 55

AMS 3B S 55 Dimensions

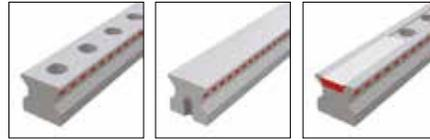

	AMS 3B S 55-N	AMS 3B S 55-NU	AMS 3B S 55-C			
B1: Rail width	53	53	53			
J1: Rail height	48	48	48			
L3: Rail length max.	6000	6000	6000			
L4: Spacing of fixing holes	60	60	60			
L5/L10: Position of first/last fixing hole	28.5	28.5	28.5			
Gew.: Rail weight, specific (kg/m)	15.2	16.6	14.9			

Available options for AMS 3B S 55



AMS 3B W 55 Dimensions and capacities



	AMS 3B W 55-A	AMS 3B W 55-B	AMS 3B W 55-C	AMS 3B W 55-D	AMS 3B W 55-G	
A: System height	70	70	80	80	70	
A1: Half width of housing on opposite side	49	49	49	49	49	
A2: Half width of housing on reading head side	49	49	49	49	49	
A3: Projection of reading head	3.5	3.5	3.5	3.5	3.5	
B: Carriage width	140	140	100	100	100	
B2: Distance between locating faces	43.5	43.5	23.5	23.5	23.5	
C1: Position of center front lube hole	9	9	19	19	9	
C3: Position of lateral lube hole	9	9	19	19	9	
C4: Position of lateral lube hole	25.75	46.75	35.75	46.75	46.75	
C7: Position of top lube hole	21.5	42.5	31.5	42.5	42.5	
J: Carriage height	57	57	67	67	57	
L1: Exterior fixing hole spacing	95	95	75	95	95	
L2: Interior fixing hole spacing	70	70	-	-	-	
L9: Carriage length with housing	226.7	268.7	226.7	268.7	268.7	
L11: Housing length	84.9	84.9	84.9	84.9	84.9	
Lw: Inner carriage body length	120	162	120	162	162	
N: Lateral fixing hole spacing	116	116	75	75	75	
O: Reference face height	12	12	12	12	12	
Ts: Front plate thickness	21.8	21.8	21.8	21.8	21.8	
Capacities and weights						
C0: Static load capacity (N)	237000	324000	237000	324000	324000	
C100: Dynamic load capacity (N)	131900	180500	131900	180500	180500	
MOQ: Static cross moment capacity (Nm)	7771	10624	7771	10624	10624	
MOL: Static longitud. moment capacity (Nm)	4738	8745	4325	8745	8745	
MQ: Dyn. cross moment capacity (Nm)	4325	5919	4325	5919	5919	
ML: Dyn. longitud. moment capacity (Nm)	2637	4872	2637	4872	4872	
Gew: Carriage weight (kg)	5.9	7.7	5.5	7.0	5.7	

Available options for AMS 3B W 55



7.2 Technical data and options

AMS 3B Size 65

AMS 3B S 65 Dimensions



	AMS 3B S 65-N	AMS 3B S 65-NU	AMS 3B S 65-C			
B1: Rail width	63	63	63			
J1: Rail height	58	58	58			
L3: Rail length max.	6000	6000	6000			
L4: Spacing of fixing holes	75	75	75			
L5/L10: Position of first/last fixing hole	36	36	36			
Gew.: Rail weight, specific (kg/m)	22.8	24.5	22.5			

Available options for AMS 3B S 65



AMS 3B W 65 Dimensions and capacities



	AMS 3B W 65-A	AMS 3B W 65-B	AMS 3B W 65-C	AMS 3B W 65-D		
A: System height	90	90	90	90		
A1: Half width of housing on opposite side	61.5	61.5	61.5	61.5		
A2: Half width of housing on reading head side	61.5	61.5	61.5	61.5		
A3: Projection of reading head	0	0	0	0		
B: Carriage width	170	170	126	126		
B2: Distance between locating faces	53.5	53.5	31.5	31.5		
C1: Position of center front lube hole	13	13	13	13		
C3: Position of lateral lube hole	13	13	13	13		
C4: Position of lateral lube hole	31.75	58	51.75	53		
C7: Position of top lube hole	27.75	54	47.75	49		
J: Carriage height	76	76	76	76		
L1: Exterior fixing hole spacing	110	110	70	120		
L2: Interior fixing hole spacing	82	82	-	-		
L9: Carriage length with housing	262.5	315	262.5	315		
L11: Housing length	89	89	89	89		
Lw: Inner carriage body length	148.5	201	148.5	201		
N: Lateral fixing hole spacing	142	142	76	76		
O: Reference face height	15	15	15	15		
Ts: Front plate thickness	25	25	25	25		
Capacities and weights						
C0: Static load capacity (N)	419000	530000	419000	530000		
C100: Dynamic load capacity (N)	232000	295000	232000	295000		
MOQ: Static cross moment capacity (Nm)	16446	20912	16446	20912		
MOL: Static longitud. moment capacity (Nm)	10754	17930	10754	17930		
MQ: Dyn. cross moment capacity (Nm)	9154	11640	9154	11640		
ML: Dyn. longitud. moment capacity (Nm)	5954	9980	5954	9980		
Gew: Carriage weight (kg)	11.6	14.9	9.4	11.8		

Available options for AMS 3B W 65



AMS 3B Rails accessories overview

Accessories	AMS 3B S 25	AMS 3B S 35	AMS 3B S 45	AMS 3B S 55	AMS 3B S 65
Plugs:					
Plastic plugs	MRK 25	MRK 35	MRK 45	MRK 55	MRK 65
Brass plugs	MRS 25	MRS 35	MRS 45	MRS 55	MRS 65
Steel plugs	MRZ 25	MRZ 35	MRZ 45	MRZ 55	MRZ 65
Cover strips:					
Cover strip (spare part)	MAC 25	MAC 35	MAC 45	MAC 55	MAC 65
End piece for cover strip (spare part)	EST 25-MAC	EST 35-MAC	EST 45-MAC	EST 55-MAC	EST 65-MAC
Assembly tools:					
Installation tool for steel plugs	MWH 25	MWH 35	MWH 45	MWH 55	MWH 65
Hydraulic cylinder for MWH	MZH	MZH	MZH	MZH	MZH
Installation tool for cover strip	MWC 25	MWC 35	MWC 45	MWC 55	MWC 65

AMS 3B Carriages accessories overview

Accessories	AMS 3B W 25	AMS 3B W 35	AMS 3B W 45	AMS 3B W 55	AMS 3B W 65
Additional wipers:					
Additional wipers NBR	ZCN 25	ZCN 35	ZCN 45	ZCN 55	ZCN 65
Additional wipers Viton	ZCV 25	ZCV 35	ZCV 45	ZCV 55	ZCV 65
Metal wiper	ASM 25-A	ASM 35-A	ASM 45-A	ASM 55-A	ASM 65-A
Bellows:					
Bellows	FBM 25	FBM 35	FBM 45	FBM 55	FBM 65
Adapter plate for bellows (spare part)	ZPL 25	ZPL 35	ZPL 45	ZPL 55	ZPL 65
End plate for bellows (spare part)	EPL 25	EPL 35	EPL 45	EPL 55	EPL 65
Assembly rails:					
Assembly rail	MRM 25	MRM 35	MRM 45	MRM 55	MRM 65
Lubrication plates:					
Lubrication plate	SPL 25-MR	SPL 35-MR	SPL 45-MR	SPL 55-MR	SPL 65-MR
Front plates:					
Front plate (spare part)	STP 25-EK	STP 35-EK	STP 45-EK	STP 55-EK	STP 65-EK
Lube nipples:					
Hydraulic-type grease nipple straight	SN 6	SN 6	SN 6	SN 6	SN 6
Hydraulic-type grease nipple 45°	SN 6-45	SN 6-45	SN 6-45	SN 6-45	SN 6-45
Hydraulic-type grease nipple 90°	SN 6-90	SN 6-90	SN 6-90	SN 6-90	SN 6-90
Flush type grease nipple M3	SN 3-T	-	-	-	-
Flush type grease nipple M6	SN 6-T	SN 6-T	SN 6-T	SN 6-T	SN 6-T
Grease gun for SN 3-T und SN 6-T	SFP-T3	SFP-T3	SFP-T3	SFP-T3	SFP-T3
Lube adapters:					
Straight screw-in connection M3	SA 3-D3	-	-	-	-
Lubrication adapter M8 round-head	SA 6-RD-M8	SA 6-RD-M8	SA 6-RD-M8	SA 6-RD-M8	SA 6-RD-M8
Lubrication adapter M8 hexagon head	-	SA 6-6KT-M8	SA 6-6KT-M8	SA 6-6KT-M8	SA 6-6KT-M8
Lubrication adapter G1/8 hexagon head	-	SA 6-6KT-G1/8	SA 6-6KT-G1/8	SA 6-6KT-G1/8	SA 6-6KT-G1/8
Swivel screw connection for pipe d=4 mm	SV 6-D4	SV 6-D4	SV 6-D4	SV 6-D4	SV 6-D4
Swivel screw connection M6	SV 6-M6	SV 6-M6	SV 6-M6	SV 6-M6	SV 6-M6
Swivel screw connection M6 long	SV 6-M6-L	SV 6-M6-L	SV 6-M6-L	SV 6-M6-L	SV 6-M6-L
Swivel screw connection M8	SV 6-M8	SV 6-M8	SV 6-M8	SV 6-M8	SV 6-M8
Swivel screw connection M8 long	SV 6-M8-L	SV 6-M8-L	SV 6-M8-L	SV 6-M8-L	SV 6-M8-L
Cables:					
Connecting cable, 12-pole	KAO 12-X	KAO 12-X	KAO 12-X	KAO 12-X	KAO 12-X
Connecting cable, 12-pole	KAO 13-X	KAO 13-X	KAO 13-X	KAO 13-X	KAO 13-X
Extension cable, 12-pole	KAO 14-X	KAO 14-X	KAO 14-X	KAO 14-X	KAO 14-X
Extension cable, 12-pole	KAO 15-X	KAO 15-X	KAO 15-X	KAO 15-X	KAO 15-X
Connecting cable, 12-pole	KAO 16-X	KAO 16-X	KAO 16-X	KAO 16-X	KAO 16-X

7.4 Order key

Analog

Individual guide rails and carriages are ordered in accordance with the order codes described below.

AMS 3B carriages consist of guide carriage, casing and reading head.

All MONORAIL MR carriages can also be used with AMS 3B rails.

Q.v. chapter 2 and chapter 3.3 for the order key for accessories.

Separate order codes are used in each case for rails, carriages and accessories. This also applies to different versions of rails and carriages.

All guide components are supplied individually as standard, i.e. unassembled.

If required, SCHNEEBERGER can also supply rails and carriages assembled incl. accessories as complete systems. Please note the ordering instructions in chapter 2.4 if this applies.

The order code for the AMS 3B systems is made up of two groups. For the AMS system with an analog interface, the code is AMSA. The AMS system with a digital interface is referred to as AMSD.

Order code for AMSA 3B Rails

	1x	AMSA 3B S	35	-N	-G1	-KC	-R12	-918	-19	-19	-CN	-TR50
Quantity												
Rail												
Size												
Type												
Accuracy												
Straightness												
Reference side												
Rail length L3												
Position of first fixing hole L5												
Position of last fixing hole L10												
Coating												
Magnetization												

NB

Q.v. chapter 7.1 to 7.3 for an overview of types, details of shapes, available options and accessories.

Q.v. chapter 2 for a description of the options.

If possible, standard lengths are preferred for L3 rail length.

These are calculated with the table values in chapter 7.2 using the following formula: $L3 = n \times L4 + L5 + L10 \leq L3max.$

Order code for AMSA 3B Carriages

	1x	AMSA 3B W	35	-A	-P1	-G1	-V3	-R1	-CN	-S10	-LN	-TSU
Quantity												
Carriage												
Size												
Type												
Reading head position												
Accuracy												
Preload												
Reference side												
Coating												
Lube connection												
Lubrication as delivered condition												
Interface												

Anmerkungen

Typenübersicht, Details zu den Bauformen, verfügbare Optionen und Zubehör siehe Kapitel 7.1 bis 7.3.

Beschreibung der Optionen siehe Kapitel 2.

Order code for AMSD 3B Rails

	1x	AMSD 3B S	-35	-N	-G1	-KC	-R12	-918	-19	-19	-CN	-TR50
Quantity												
Rail												
Size												
Type												
Accuracy												
Straightness												
Reference side												
Rail length L3												
Position of first fixing hole L5												
Position of last fixing hole L10												
Coating												
Magnetization												

NB

Q.v. chapter 7.1 to 7.3 for an overview of types, details of shapes, available options and accessories.

Q.v. chapter 2 for a description of the options.

If possible, standard lengths are preferred for L3 rail length.

These are calculated with the table values in chapter 7.2 using the following formula: $L3 = n \times L4 + L5 + L10 \leq L3max$.

Order code for AMSD 3B Carriages

	1x	AMSD 3B W	-35	-A	-P1	-G1	-V3	-R1	-CN	-S10	-LN	-TSD	-050	-80	ZN
Quantity															
Carriage															
Size															
Type															
Reading head position															
Accuracy															
Preload															
Reference side															
Coating															
Lube connection															
Lubrication as delivered condition															
Interface															
Interpolation															
Frequency															
Reference pulse															

NB

Q.v. chapter 7.1 to 7.3 for an overview of types, details of shapes, available options and accessories.

Q.v. chapter 2 for a description of the options.

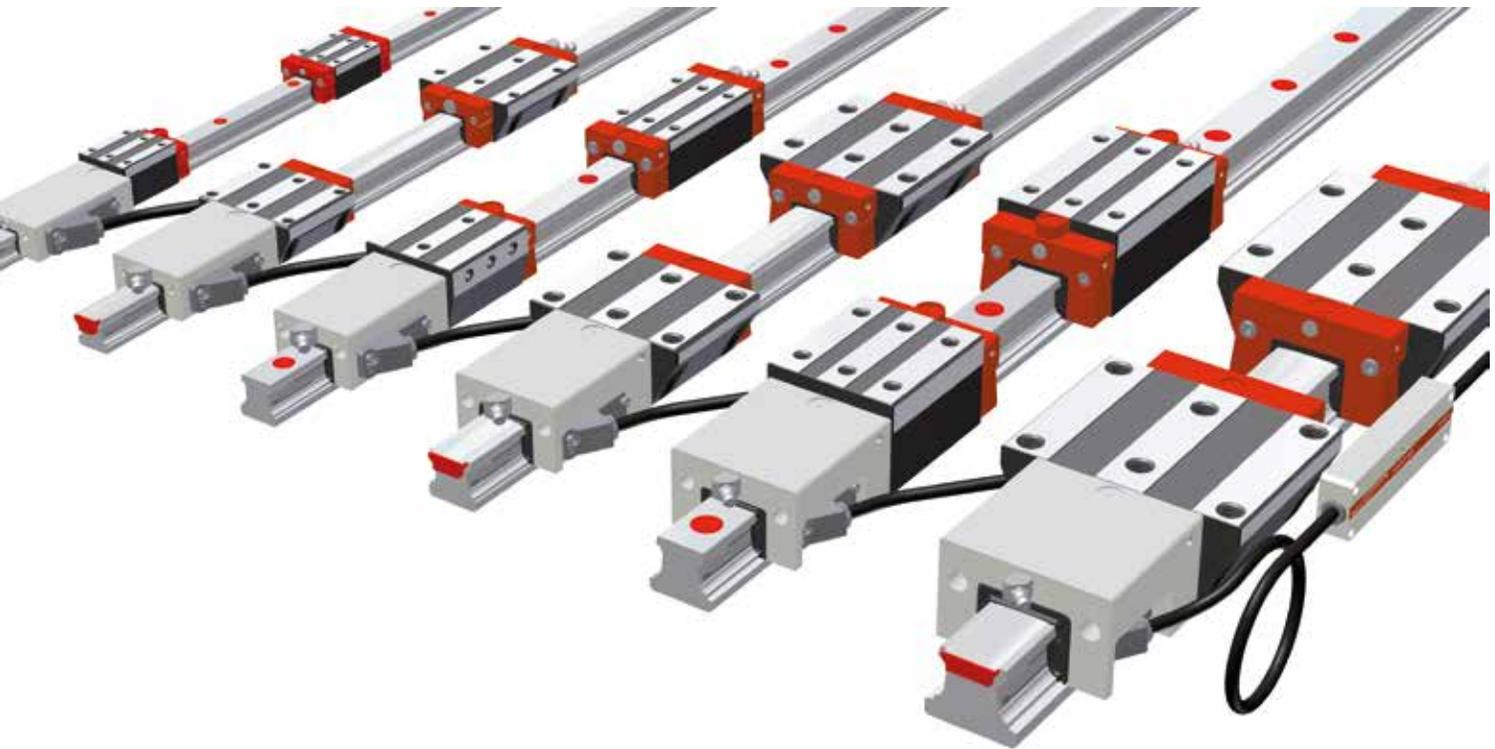

SCHNEEBERGER's MONORAIL AMS 4B is an integrated measuring system for distance measurement for use on all protected machine tool axes with lower machining forces and high demands on system precision. Mechanically the AMS 4B is based on SCHNEEBERGER's MONORAIL BM ball guide with lengths up to 6 metres. The integration of the measurement system allows very compact axes to be put together. A digital interface with a range of different resolutions for different maximum speeds, and an analog 1Vpp (200 µm signal period) interface are available as interfaces with the control system. Reference marks can be set at 50mm intervals or distance coded. Different options for carriage lubrication and sealing permit the best possible degree of adaptation to application requirements. The easily interchangeable reading head is identical for all sizes.

Features of System MONORAIL AMS 4B

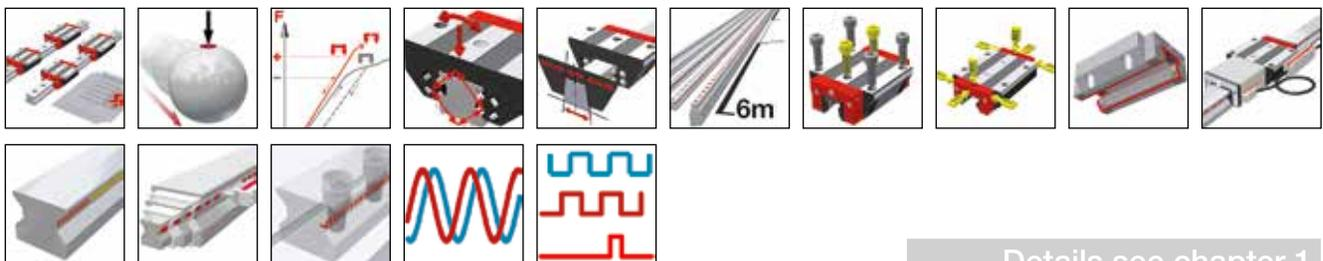

Details see chapter 1

8.1 Overview of types, sizes and available options

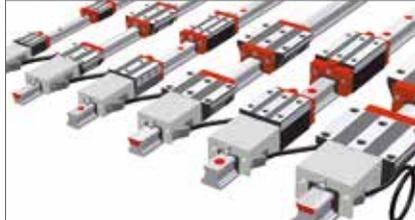

Product overview AMS 4B Rails	Page 136
Product overview AMS 4B Carriages	Page 137

8.2 Technical data and options

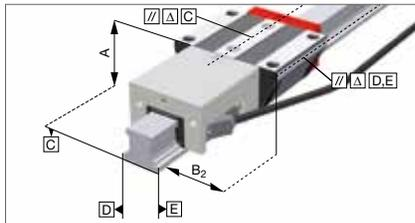

AMS 4B Size 15	Page 138
AMS 4B Size 20	Page 140
AMS 4B Size 25	Page 142
AMS 4B Size 30	Page 144
AMS 4B Size 35	Page 146
AMS 4B Size 45	Page 148

8.3 Accessories MONORAIL AMS 4B



Accessories overview	Page 150
AMS 4B Rails accessory details	Page 79
AMS 4B Carriages accessory details	Page 81

8.4 Order key

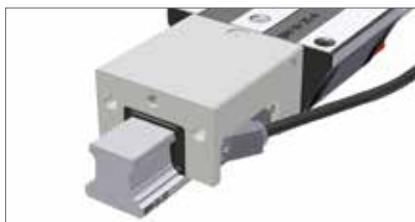

Order key AMSA 4B Rails	Page 151
Order key AMSA 4B Carriages	Page 151
Order key AMSD 4B Rails	Page 152
Order key AMSD 4B Carriages	Page 152

8.1 Overview of types, sizes and available options AMS 4B Rails

Product overview AMS 4B Rails

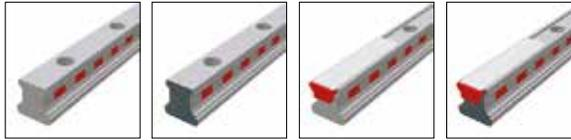

	N standard	ND standard, through hardened	C for cover strip	CD for cover strip, through hardened		
Buildsizes / Rail build forms						
Size 15		AMS 4B S 15-ND		AMS 4B S 15-CD		
Size 20	AMS 4B S 20-N		AMS 4B S 20-C			
Size 25	AMS 4B S 25-N		AMS 4B S 25-C			
Size 30	AMS 4B S 30-N		AMS 4B S 30-C			
Size 35	AMS 4B S 35-N		AMS 4B S 35-C			
Size 45	AMS 4B S 45-N		AMS 4B S 45-C			
Features						
Screwable from above	●	●	●	●		
Small assembly effort			●	●		
Great single-part system length	●		●			
For the support of metal covers		●				

Available options for AMS 4B Rails

Details see chapter 2

Accuracy

- G0 Highly accurate
- G1 Very accurate
- G2 Accurate
- G3 Standard

Straightness

- KC Standard

Coating

- CN None
- CH Hard chromium

Locating sides

- R11 Ref.bottom, scale bottom
- R12 Ref.bottom, scale top
- R21 Ref.top, scale bottom
- R22 Ref.top, scale top

Magnetisierung

- TR50 50 mm Raster
- T020 20 mm Code
- T050 50 mm Code

Available accessories for AMS 4B Rails

Details see chapter 4.3

Plugs

Cover strips

Assembly tools

8.1 Overview of types, sizes and available options AMS 4B Carriages

Product overview AMS 4B Carriages

							
	A standard	B standard, long	C compact, high	D compact, high, long	E compact, high, for lateral fixing	F compact	G compact, long
Buildsizes / Carriage build forms							
Size 15	AMS 4B W 15-A		AMS 4B W 15-C			AMS 4B W 15-F	
Size 20	AMS 4B W 20-A	AMS 4B W 20-B	AMS 4B W 20-C	AMS 4B W 20-D			
Size 25	AMS 4B W 25-A	AMS 4B W 25-B	AMS 4B W 25-C	AMS 4B W 25-D	AMS 4B W 25-E	AMS 4B W 25-F	AMS 4B W 25-G
Size 30	AMS 4B W 30-A	AMS 4B W 30-B	AMS 4B W 30-C	AMS 4B W 30-D	AMS 4B W 30-E	AMS 4B W 30-F	AMS 4B W 30-G
Size 35	AMS 4B W 35-A	AMS 4B W 35-B	AMS 4B W 35-C	AMS 4B W 35-D	AMS 4B W 35-E	AMS 4B W 35-F	AMS 4B W 35-G
Size 45	AMS 4B W 45-A	AMS 4B W 45-B	AMS 4B W 45-C	AMS 4B W 45-D		AMS 4B W 45-F	AMS 4B W 45-G
Features							
Screwable from above	•	•	•	•		•	•
Screwable from below	•	•					
Screwable from the side					•		
For high loads and moments		•		•			•
For medium loads and moments	•		•		•	•	
For limited installation space						•	•

Available options for AMS 4B Carriages

Details see chapter 2

Accuracy

-  **G0** Highly accurate
-  **G1** Very accurate
-  **G2** Accurate
-  **G3** Standard

Preload

-  **V0** Very Low
-  **V1** Low
-  **V2** Medium
-  **V3** High

Reference side

-  **R1** Ref. at bottom
-  **R2** Ref. on top

Coating

-  **CN** None
-  **CH** Hard chromium

Lube connections

-  **S10** Left center
-  **S20** Right center
-  **S11** Top left
-  **S21** Top right
-  **S12** Lower left side
-  **S22** Lower right side

-  **S13** Upper left side
-  **S23** Upper right side
-  **S32** Left side
-  **S42** Right side

Lubrication

-  **LN** Oil protect
-  **LG** Grease protect
-  **LV** Full greasing

Interface

-  **TMU** TMU, analog, 0.3m
-  **TRU** TRU, analog, 3m
-  **TSU** TSU, analog, 3m
-  **TMD** TMD, digital, 0.3m
-  **TRD** TRD, digital, 3m
-  **TSD** TSD, digital, 3m

Reading head position

-  **P1** Right top
-  **P3** Left bottom

Available accessories for AMS 4B Carriages

Details see chapter 2.1 and 4.3

Additional wipers
Front plates

Bellows
Lube nipples

Assembly rails
Lube adapters

Lubrication plates
Cables

AMS 4B S 15 Drawings

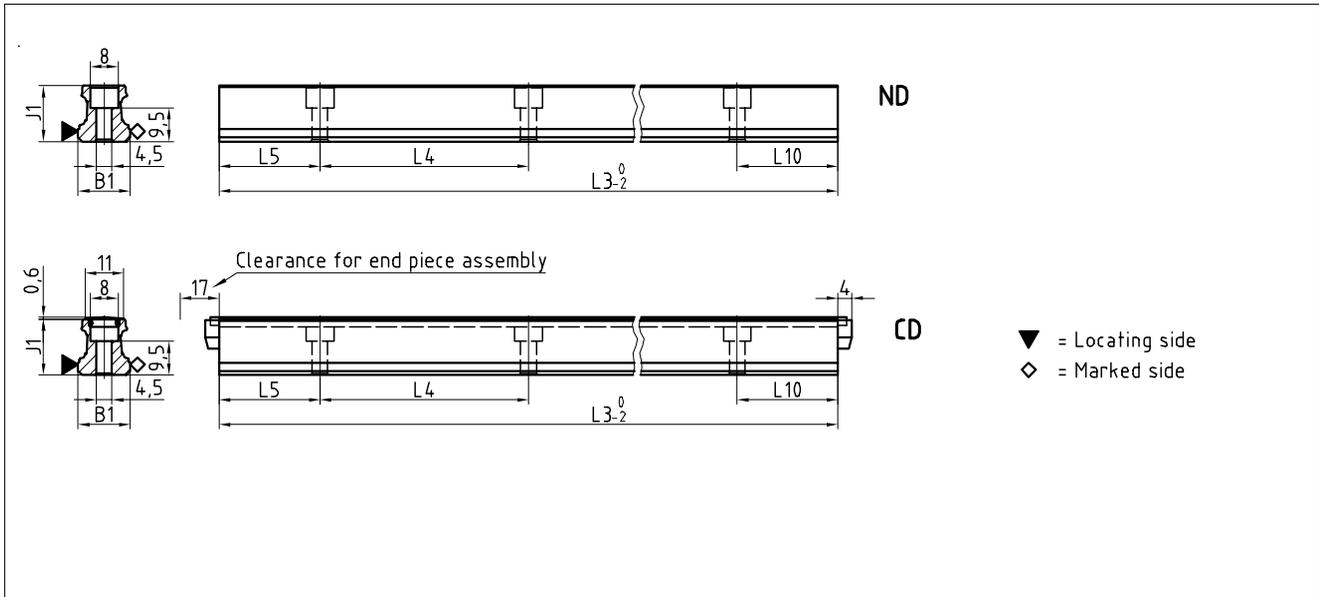

AMS 4B W 15 Drawings

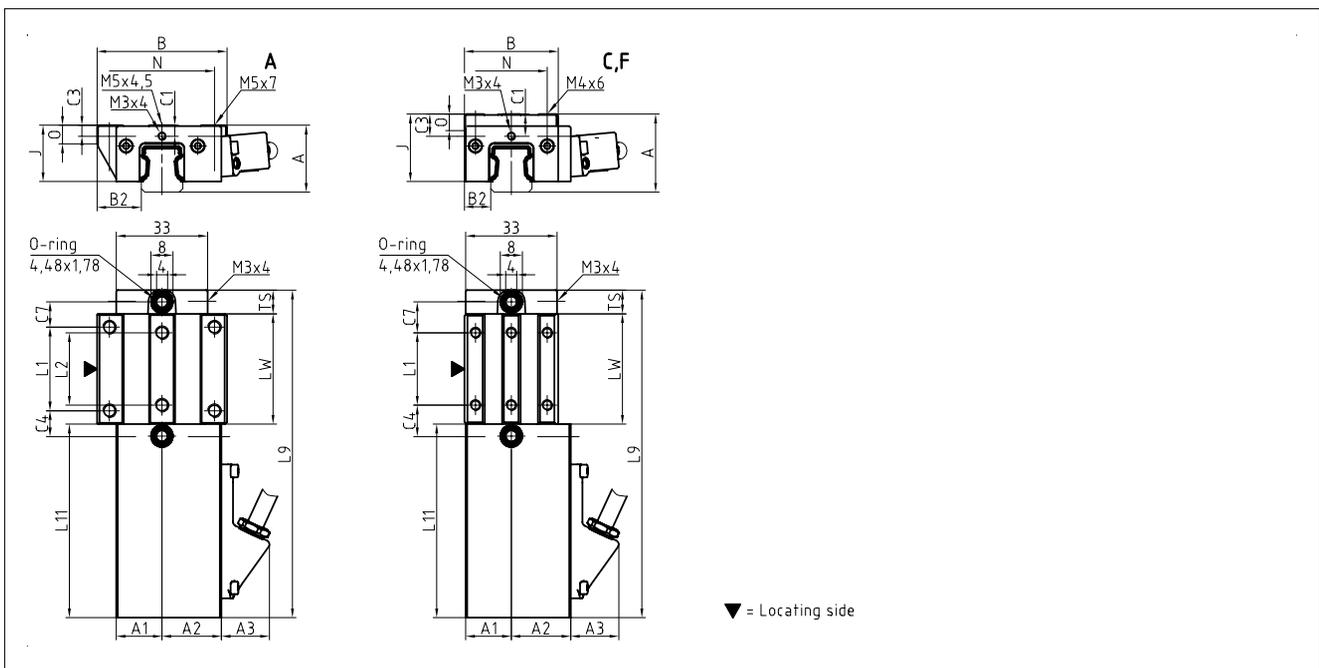

AMS 4B W 15 Rigidity diagram

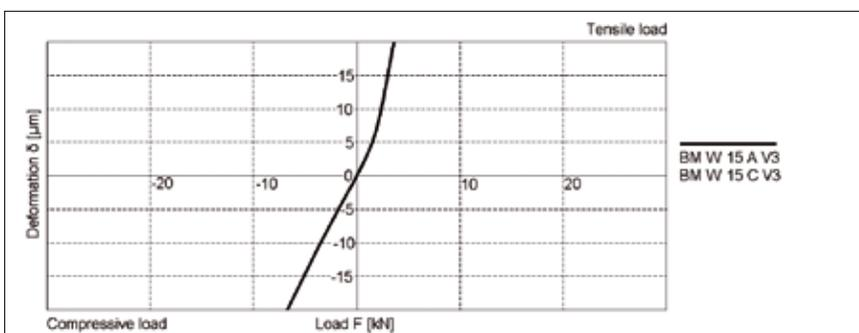

AMS 4B W 15 Load rating

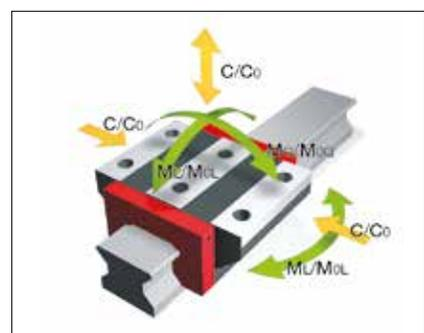

8.2 Technical data and options

AMS 4B Size 15

AMS 4B S 15 Dimensions

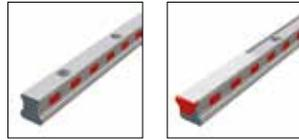

	AMS 4B S 15-ND	AMS 4B S 15-CD				
B1: Rail width	15	15				
J1: Rail height	15.7	15.7				
L3: Rail length max.	1500	1500				
L4: Spacing of fixing holes	60	60				
L5/L10: Position of first/last fixing hole	28.5	28.5				
Gew.: Rail weight, specific (kg/m)	1.4	1.3				

Available options for AMS 4B S 15



AMS 4B W 15 Dimensions and capacities



	AMS 4B W 15-A	AMS 4B W 15-C	AMS 4B W 15-F			
A: System height	24	28	24			
A1: Half width of housing on opposite side	16.5	16.5	16.5			
A2: Half width of housing on reading head side	21.5	21.5	21.5			
A3: Projection of reading head	17.5	17.5	17.5			
B: Carriage width	47	34	34			
B2: Distance between locating faces	16	9.5	9.5			
C1: Position of center front lube hole	4	8	4			
C3: Position of lateral lube hole	3.7	7.7	3.7			
C4: Position of lateral lube hole	9.3	11.3	11.3			
C7: Position of top lube hole	9.05	11.05	11.05			
J: Carriage height	20.2	24.2	20.2			
L1: Exterior fixing hole spacing	30	26	26			
L2: Interior fixing hole spacing	26	-	-			
L9: Carriage length with housing	117.6	117.6	117.6			
L11: Housing length	69.5	69.5	69.5			
Lw: Inner carriage body length	39.6	39.6	39.6			
N: Lateral fixing hole spacing	38	26	26			
O: Reference face height	7	6	5.5			
Ts: Front plate thickness	8.5	8.5	8.5			
Capacities and weights						
C0: Static load capacity (N)	19600	19600	19600			
C100: Dynamic load capacity (N)	9000	9000	9000			
MOQ: Static cross moment capacity (Nm)	181	181	181			
MOL: Static longitud. moment capacity (Nm)	146	146	146			
MQ: Dyn. cross moment capacity (Nm)	83	83	83			
ML: Dyn. longitud. moment capacity (Nm)	67	67	67			
Gew.: Carriage weight (kg)	0.8	0.8	0.7			

Available options for AMS 4B W 15



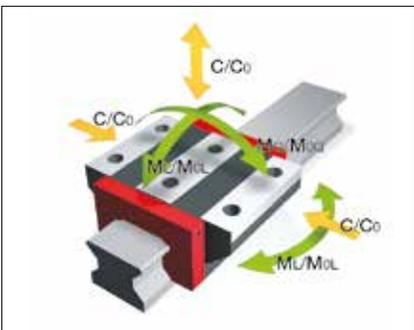
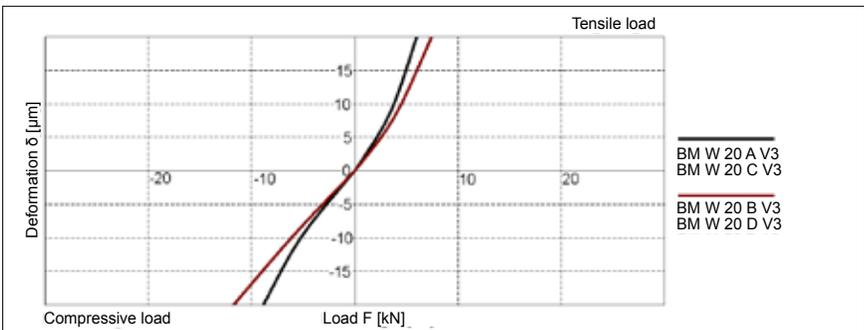
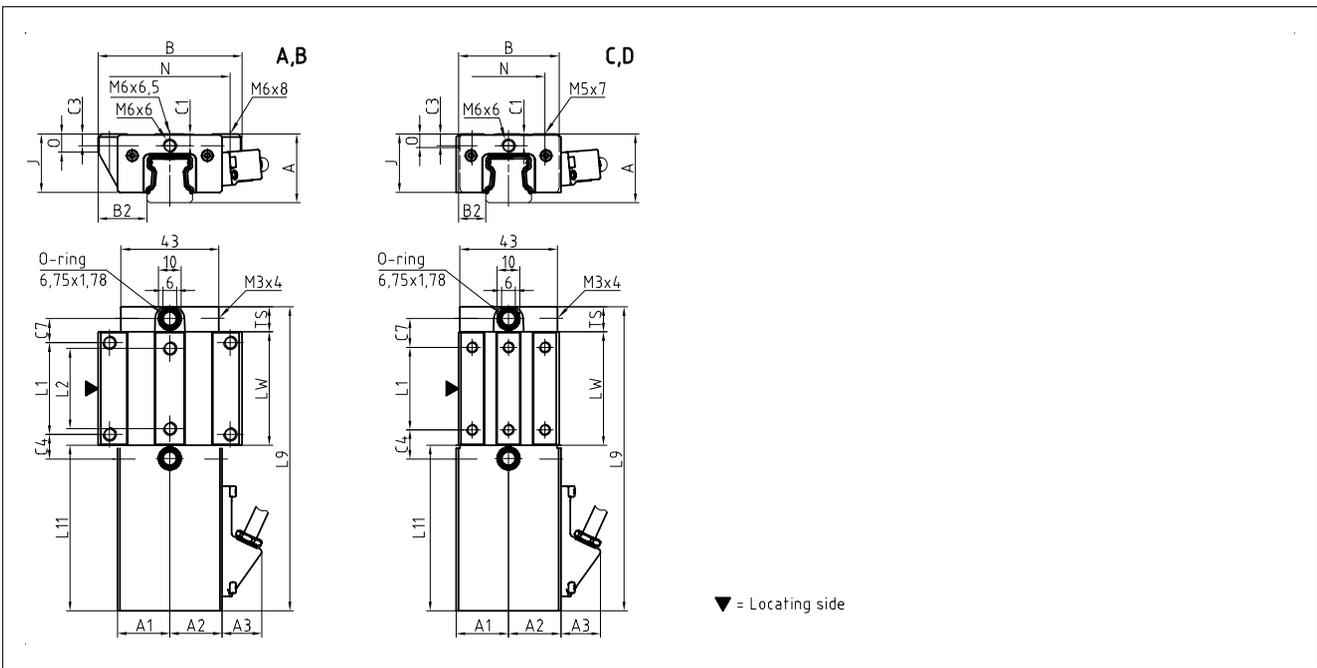
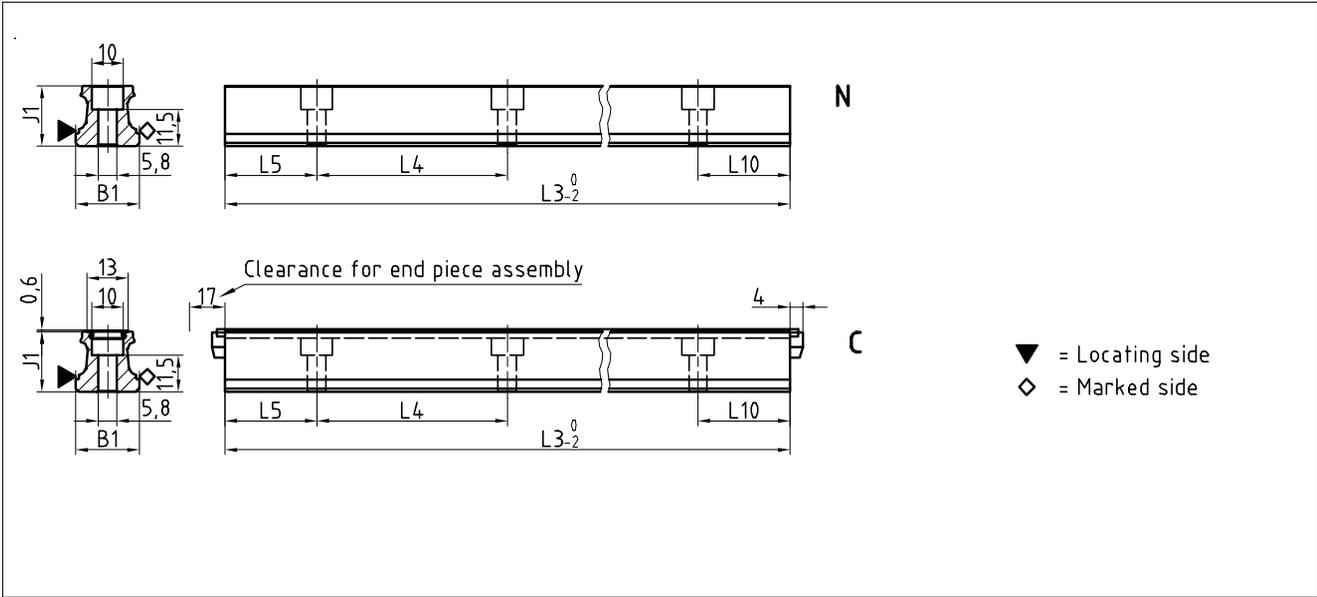

8.2 Technical data and options

AMS 4B Size 20

AMS 4B S 20 Dimensions

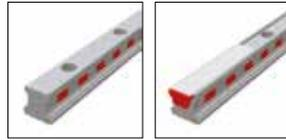

	AMS 4B S 20-N	AMS 4B S 20-C			
B1: Rail width	20	20			
J1: Rail height	19	19			
L3: Rail length max.	3000	3000			
L4: Spacing of fixing holes	60	60			
L5/L10: Position of first/last fixing hole	28.5	28.5			
Gew.: Rail weight, specific (kg/m)	2.2	2.1			

Available options for AMS 4B S 20



AMS 4B W 20 Dimensions and capacities



	AMS 4B W 20-A	AMS 4B W 20-B	AMS 4B W 20-C	AMS 4B W 20-D		
A: System height	30	30	30	30		
A1: Half width of housing on opposite side	23.9	23.9	23.9	23.9		
A2: Half width of housing on reading head side	23.9	23.9	23.9	23.9		
A3: Projection of reading head	17.5	17.5	17.5	17.5		
B: Carriage width	63	63	44	44		
B2: Distance between locating faces	21.5	21.5	12	12		
C1: Position of center front lube hole	5.2	5.2	5.2	5.2		
C3: Position of lateral lube hole	4.6	4.6	4.6	4.6		
C4: Position of lateral lube hole	10.75	18.75	12.75	13.75		
C7: Position of top lube hole	10.25	18.25	12.25	13.25		
J: Carriage height	25.5	25.5	25.5	25.5		
L1: Exterior fixing hole spacing	40	40	36	50		
L2: Interior fixing hole spacing	35	35	-	-		
L9: Carriage length with housing	132.5	148.5	132.5	148.5		
L11: Housing length	72	72	72	72		
Lw: Inner carriage body length	49.5	65.5	49.5	65.5		
N: Lateral fixing hole spacing	53	53	32	32		
O: Reference face height	8	8	6	6		
Ts: Front plate thickness	11	11	11	11		
Capacities and weights						
C0: Static load capacity (N)	31400	41100	31400	41100		
C100: Dynamic load capacity (N)	14400	17400	14400	17400		
MOQ: Static cross moment capacity (Nm)	373	490	373	490		
MOL: Static longitud. moment capacity (Nm)	292	495	292	495		
MQ: Dyn. cross moment capacity (Nm)	171	206	171	206		
ML: Dyn. longitud. moment capacity (Nm)	134	208	134	208		
Gew: Carriage weight (kg)	1.0	1.2	0.9	1.0		

Available options for AMS 4B W 20



AMS 4B S 25 Drawings

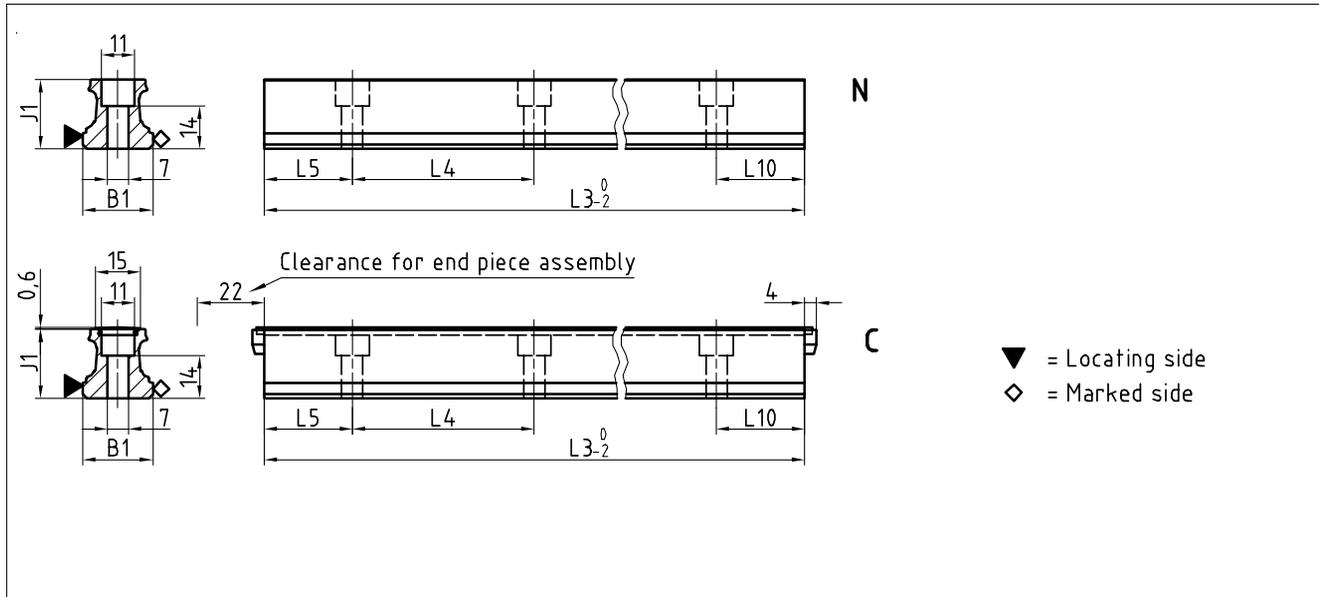

AMS 4B W 25 Drawings

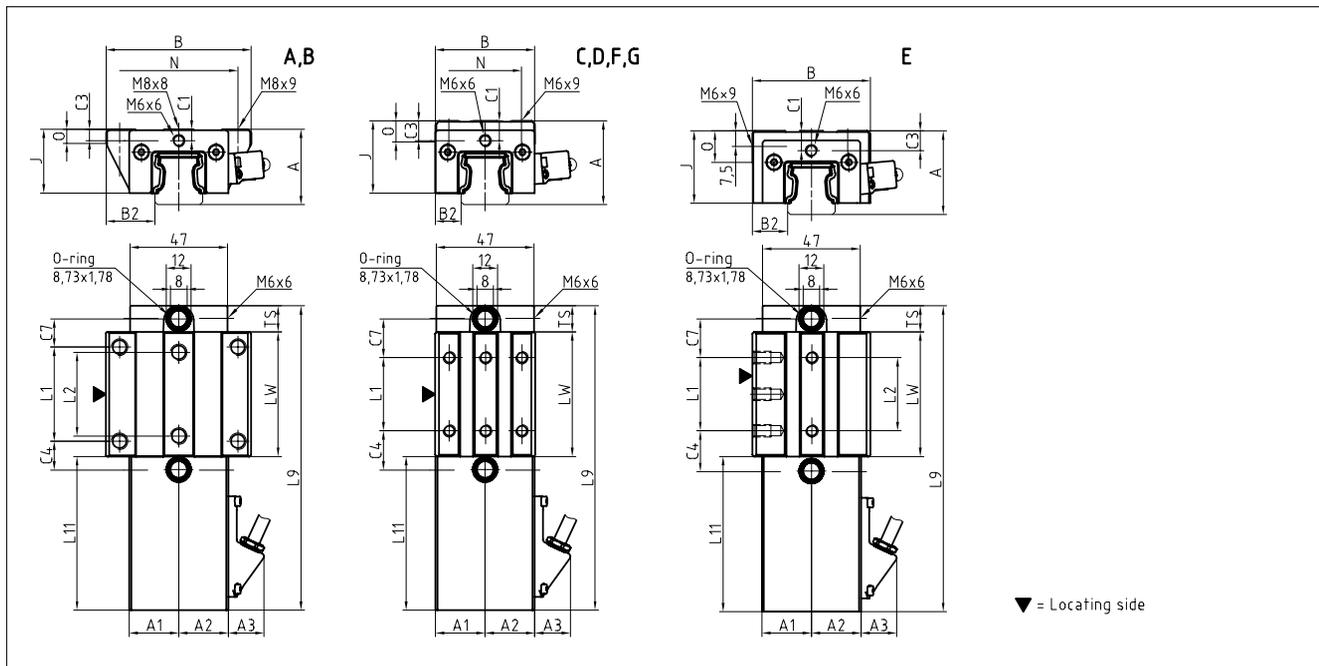

AMS 4B W 25 Rigidity diagram

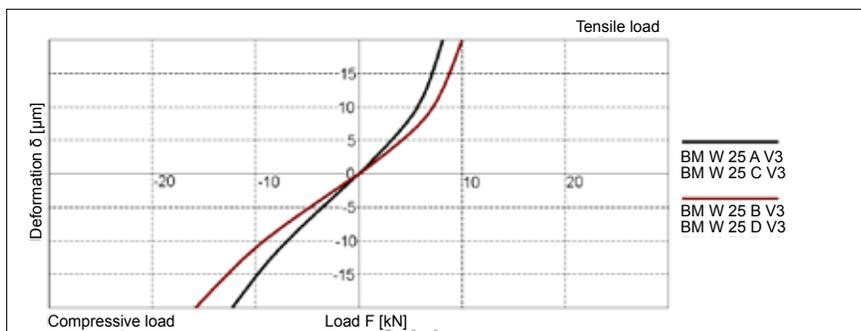

AMS 4B W 25 Load rating

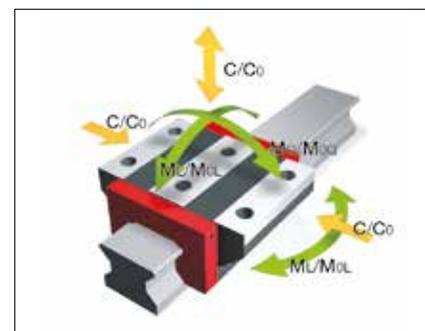

8.2 Technical data and options

AMS 4B Size 25

AMS 4B S 25 Dimensions

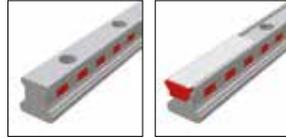

	AMS 4B S 25-N	AMS 4B S 25-C				
B1: Rail width	23	23				
J1: Rail height	22.7	22.7				
L3: Rail length max.	6000	3000				
L4: Spacing of fixing holes	60	60				
L5/L10: Position of first/last fixing hole	28.5	28.5				
Gew.: Rail weight, specific (kg/m)	3.0	2.8				

Available options for AMS 4B S 25



AMS 4B W 25 Dimensions and capacities



	AMS 4B W 25-A	AMS 4B W 25-B	AMS 4B W 25-C	AMS 4B W 25-D	AMS 4B W 25-E	AMS 4B W 25-F	AMS 4B W 25-G
A: System height	36	36	40	40	40	36	36
A1: Half width of housing on opposite side	23.9	23.9	23.9	23.9	23.9	23.9	23.9
A2: Half width of housing on reading head side	23.9	23.9	23.9	23.9	23.9	23.9	23.9
A3: Projection of reading head	17.3	17.3	17.3	17.3	17.3	17.3	17.3
B: Carriage width	70	70	48	48	57	48	48
B2: Distance between locating faces	23.5	23.5	12.5	12.5	17	12.5	12.5
C1: Position of center front lube hole	5.5	5.5	9.5	9.5	9.5	5.5	5.5
C3: Position of lateral lube hole	5.5	5.5	9.5	9.5	9.5	5.5	5.5
C4: Position of lateral lube hole	13.75	23.25	18.75	20.75	18.75	18.75	20.75
C7: Position of top lube hole	13.5	23	18.5	20.5	18.5	18.5	20.5
J: Carriage height	30.5	30.5	34.5	34.5	34.5	30.5	30.5
L1: Exterior fixing hole spacing	45	45	35	50	35	35	50
L2: Interior fixing hole spacing	40	40	-	-	-	-	-
L9: Carriage length with housing	145.5	164.5	145.5	164.5	145.5	145.5	164.5
L11: Housing length	73.5	73.5	73.5	73.5	73.5	73.5	73.5
Lw: Inner carriage body length	59.5	78.5	59.5	78.5	59.5	59.5	78.5
N: Lateral fixing hole spacing	57	57	35	35	-	35	35
O: Reference face height	7	7	11	11	15	7.1	7.1
Ts: Front plate thickness	12.5	12.5	12.5	12.5	12.5	12.5	12.5

Capacities and weights

C0: Static load capacity (N)	46100	60300	46100	60300	46100	46100	60300
C100: Dynamic load capacity (N)	21100	25500	21100	25500	21100	21100	25500
MOQ: Static cross moment capacity (Nm)	631	825	631	825	631	631	825
MOL: Static longitud. moment capacity (Nm)	513	863	513	863	513	513	863
MQ: Dyn. cross moment capacity (Nm)	289	349	289	349	289	289	349
ML: Dyn. longitud. moment capacity (Nm)	235	365	235	365	235	235	365
Gew.: Carriage weight (kg)	1.3	1.5	1.2	1.4	1.3	1.1	1.3

Available options for AMS 4B W 25



AMS 4B S 30 Drawings

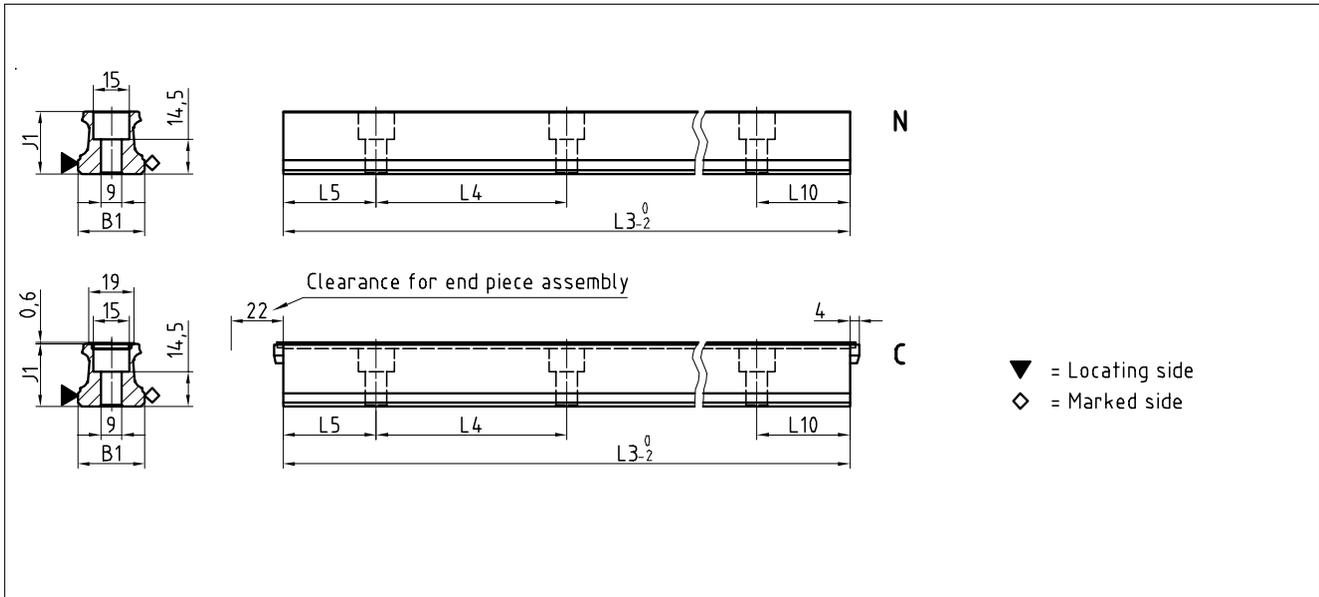

AMS 4B W 30 Drawings

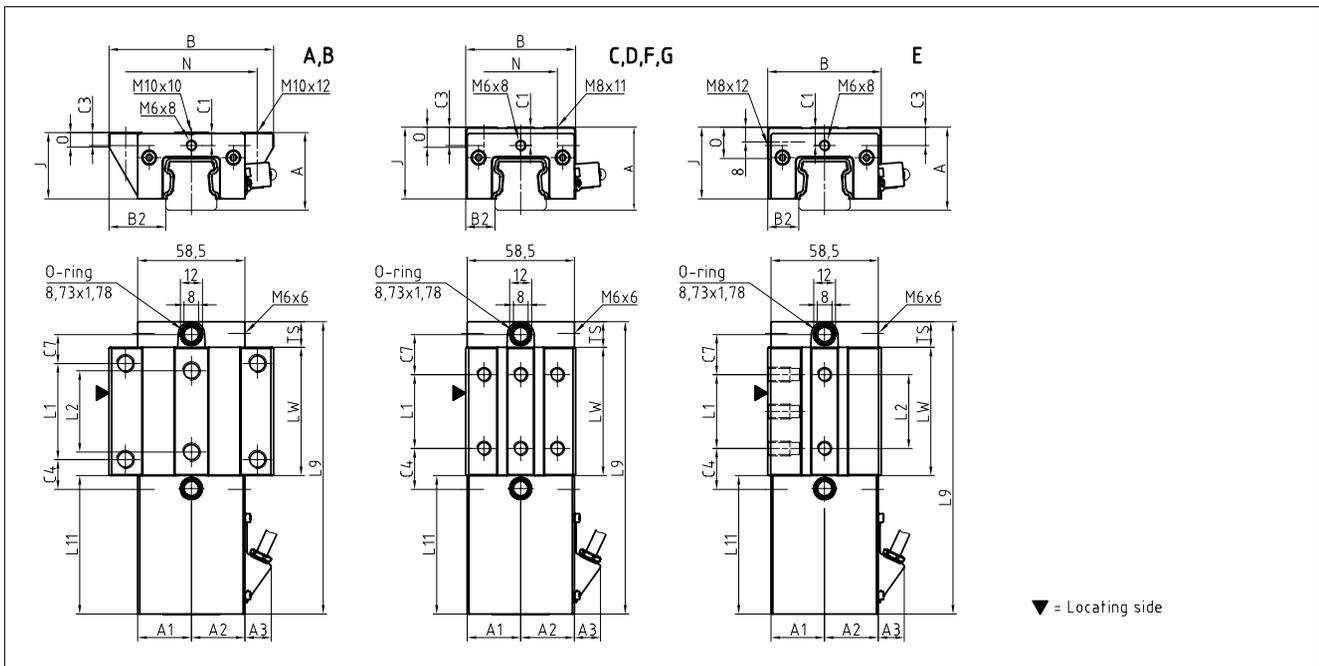

AMS 4B W 30 Rigidity diagram

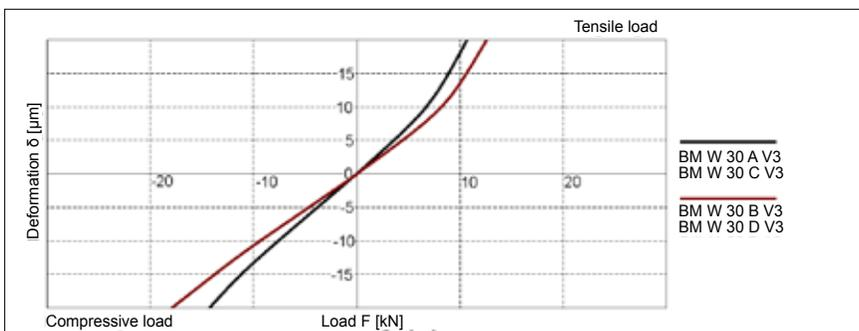

AMS 4B W 30 Load rating

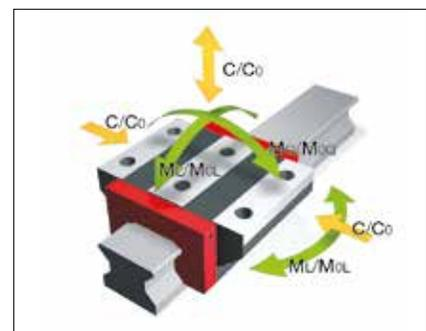

8.2 Technical data and options

AMS 4B Size 30

AMS 4B S 30 Dimensions



	AMS 4B S 30-N	AMS 4B S 30-C				
B1: Rail width	28	28				
J1: Rail height	26	26				
L3: Rail length max.	6000	6000				
L4: Spacing of fixing holes	80	80				
L5/L10: Position of first/last fixing hole	38.5	38.5				
Gew.: Rail weight, specific (kg/m)	4.3	4.1				

Available options for AMS 4B S 30



AMS 4B W 30 Dimensions and capacities



	AMS 4B W 30-A	AMS 4B W 30-B	AMS 4B W 30-C	AMS 4B W 30-D	AMS 4B W 30-E	AMS 4B W 30-F	AMS 4B W 30-G
A: System height	42	42	45	45	45	42	42
A1: Half width of housing on opposite side	29.3	29.3	29.3	29.3	29.3	29.3	29.3
A2: Half width of housing on reading head side	29.3	29.3	29.3	29.3	29.3	29.3	29.3
A3: Projection of reading head	14.4	14.4	14.4	14.4	14.4	14.4	14.4
B: Carriage width	90	90	60	60	62	60	60
B2: Distance between locating faces	31	31	16	16	17	16	16
C1: Position of center front lube hole	7	7	10	10	10	7	7
C3: Position of lateral lube hole	6	6	9	9	9	6	6
C4: Position of lateral lube hole	16.2	27.2	22.2	23.2	22.2	22.2	23.2
C7: Position of top lube hole	15.7	26.7	21.7	22.7	21.7	21.7	22.7
J: Carriage height	35.9	35.9	38.9	38.9	38.9	35.9	35.9
L1: Exterior fixing hole spacing	52	52	40	60	40	40	60
L2: Interior fixing hole spacing	44	44	-	-	40	-	-
L9: Carriage length with housing	158.4	180.4	158.4	180.4	158.4	158.4	180.4
L11: Housing length	75	75	75	75	75	75	75
Lw: Inner carriage body length	69.4	91.4	69.4	91.4	69.4	69.4	91.4
N: Lateral fixing hole spacing	72	72	40	40	-	40	40
O: Reference face height	7.8	7.8	11	11	17	8	8
Ts: Front plate thickness	14	14	14	14	14	14	14
Capacities and weights							
C0: Static load capacity (N)	63700	83300	63700	83300	63700	63700	83300
C100: Dynamic load capacity (N)	29200	35300	29200	35300	29200	29200	35300
MOQ: Static cross moment capacity (Nm)	1084	1414	1084	1414	1084	1084	1414
MOL: Static longitud. moment capacity (Nm)	829	1390	829	1390	829	829	1390
MQ: Dyn. cross moment capacity (Nm)	497	599	497	599	497	497	599
ML: Dyn. longitud. moment capacity (Nm)	380	589	380	589	380	380	589
Gew: Carriage weight (kg)	1.8	2.2	1.7	1.9	1.7	1.6	1.8

Available options for AMS 4B W 30



AMS 4B S 35 Drawings

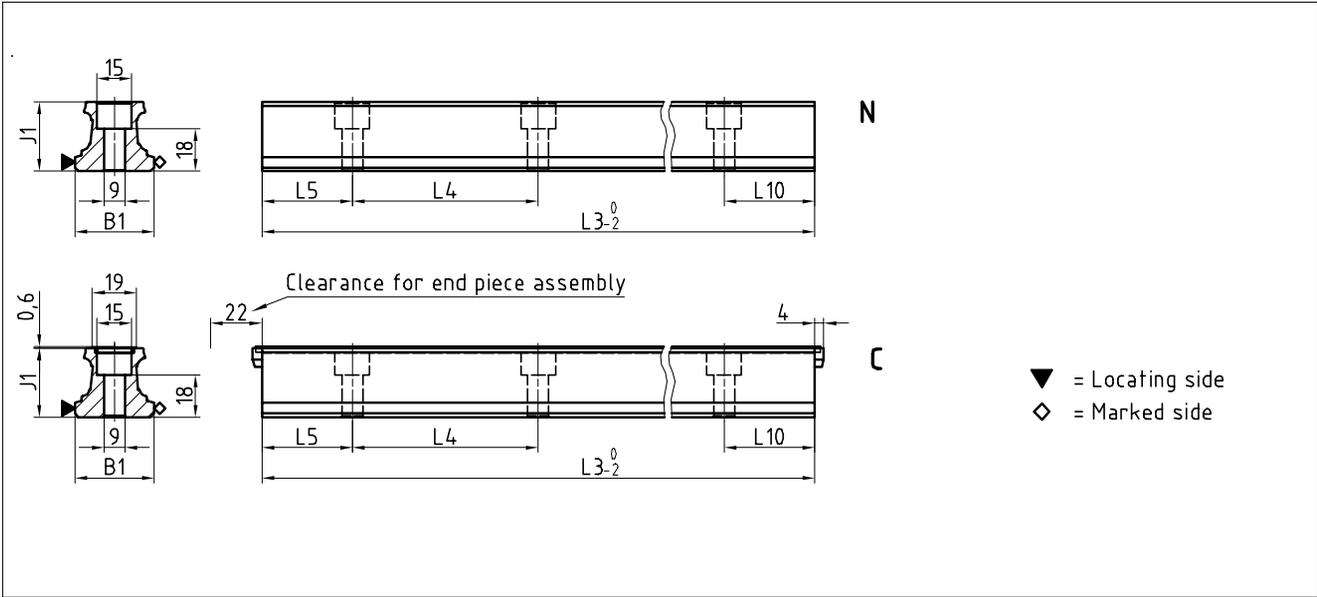

AMS 4B W 35 Drawings

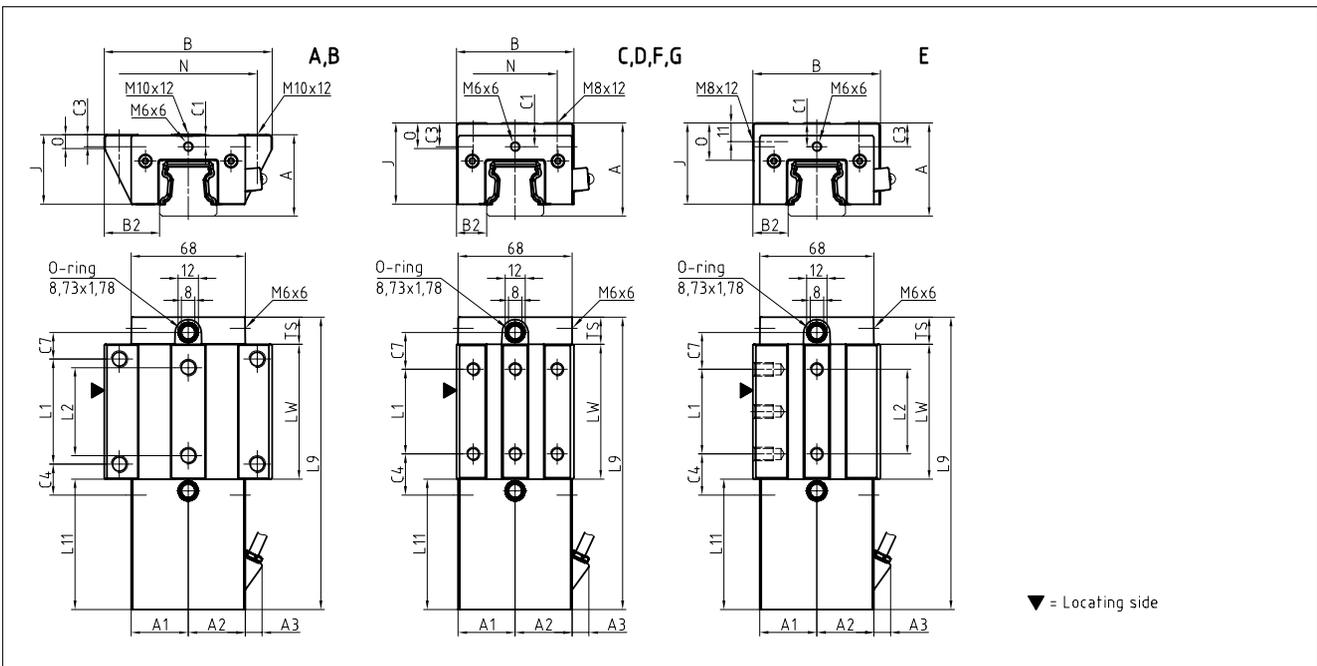

AMS 4B W 35 Rigidity diagram

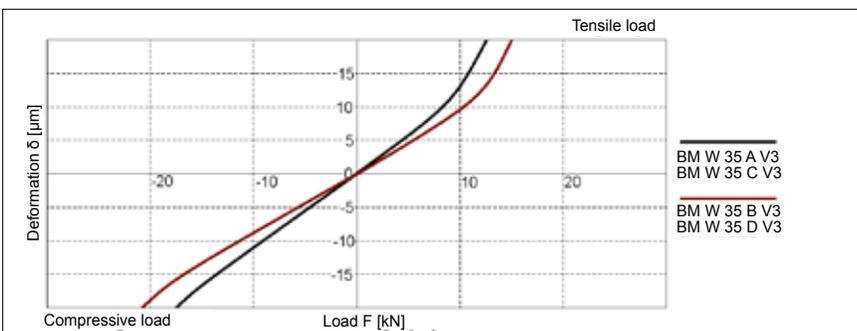

AMS 4B W 35 Load rating

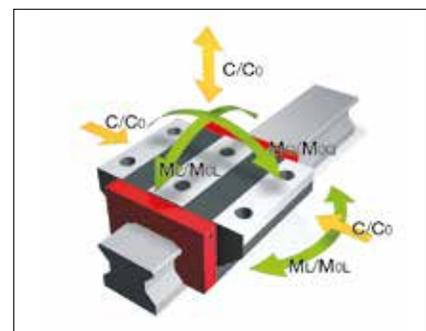

8.2 Technical data and options

AMS 4B Size 35

AMS 4B S 35 Dimensions

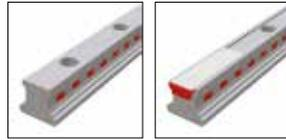

	AMS 4B S 35-N	AMS 4B S 35-C				
B1: Rail width	34	34				
J1: Rail height	29.5	29.5				
L3: Rail length max.	6000	6000				
L4: Spacing of fixing holes	80	80				
L5/L10: Position of first/last fixing hole	38.5	38.5				
Gew.: Rail weight, specific (kg/m)	5.4	5.2				

Available options for AMS 4B S 35



AMS 4B W 35 Dimensions and capacities



	AMS 4B W 35-A	AMS 4B W 35-B	AMS 4B W 35-C	AMS 4B W 35-D	AMS 4B W 35-E	AMS 4B W 35-F	AMS 4B W 35-G
A: System height	48	48	55	55	55	48	48
A1: Half width of housing on opposite side	34	34	34	34	34	34	34
A2: Half width of housing on reading head side	34	34	34	34	34	34	34
A3: Projection of reading head	10.1	10.1	10.1	10.1	10.1	10.1	10.1
B: Carriage width	100	100	70	70	76	70	70
B2: Distance between locating faces	33	33	18	18	21	18	18
C1: Position of center front lube hole	7	7	14	14	14	7	7
C3: Position of lateral lube hole	6.5	6.5	13.5	13.5	13.5	6.5	6.5
C4: Position of lateral lube hole	18.3	31.05	24.3	26.05	24.3	24.3	26.05
C7: Position of top lube hole	15.8	28.55	21.8	23.55	21.8	21.8	23.55
J: Carriage height	41	41	48	48	48	41	41
L1: Exterior fixing hole spacing	62	62	50	72	50	50	72
L2: Interior fixing hole spacing	52	52	-	-	50	-	-
L9: Carriage length with housing	172.6	198.1	172.6	198.1	172.6	172.6	198.1
L11: Housing length	77	77	77	77	77	77	77
Lw: Inner carriage body length	79.6	105.1	79.6	105.1	79.6	79.6	105.1
N: Lateral fixing hole spacing	82	82	50	50	-	50	50
O: Reference face height	8	8	15	15	22	8	8
Ts: Front plate thickness	16	16	16	16	16	16	16
Capacities and weights							
C0: Static load capacity (N)	84400	110300	84400	110300	84400	84400	110300
C100: Dynamic load capacity (N)	38700	46700	38700	46700	38700	38700	46700
MOQ: Static cross moment capacity (Nm)	1566	2048	1566	2048	1566	1566	2048
MOL: Static longitud. moment capacity (Nm)	1252	2104	1252	2104	1252	1252	2104
MQ: Dyn. cross moment capacity (Nm)	718	867	718	867	718	718	867
ML: Dyn. longitud. moment capacity (Nm)	574	891	574	891	574	574	891
Gew: Carriage weight (kg)	2.5	3.0	2.5	3.0	2.5	2.2	2.5

Available options for AMS 4B W 35



AMS 4B S 45 Drawings

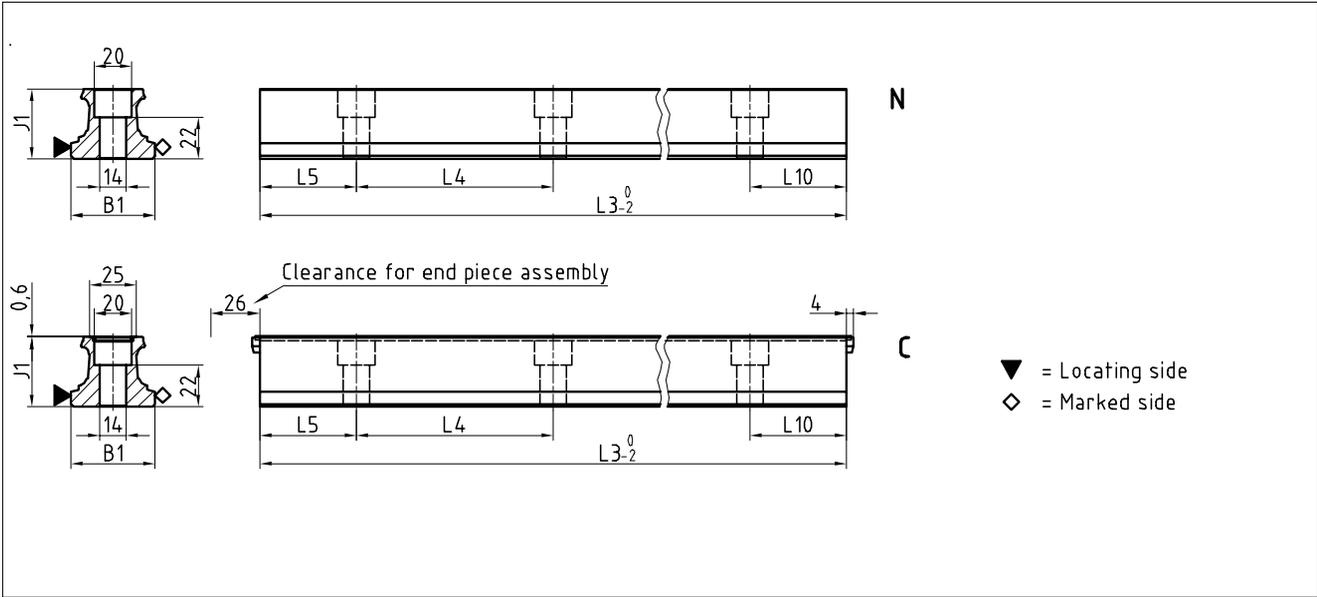

AMS 4B W 45 Drawings

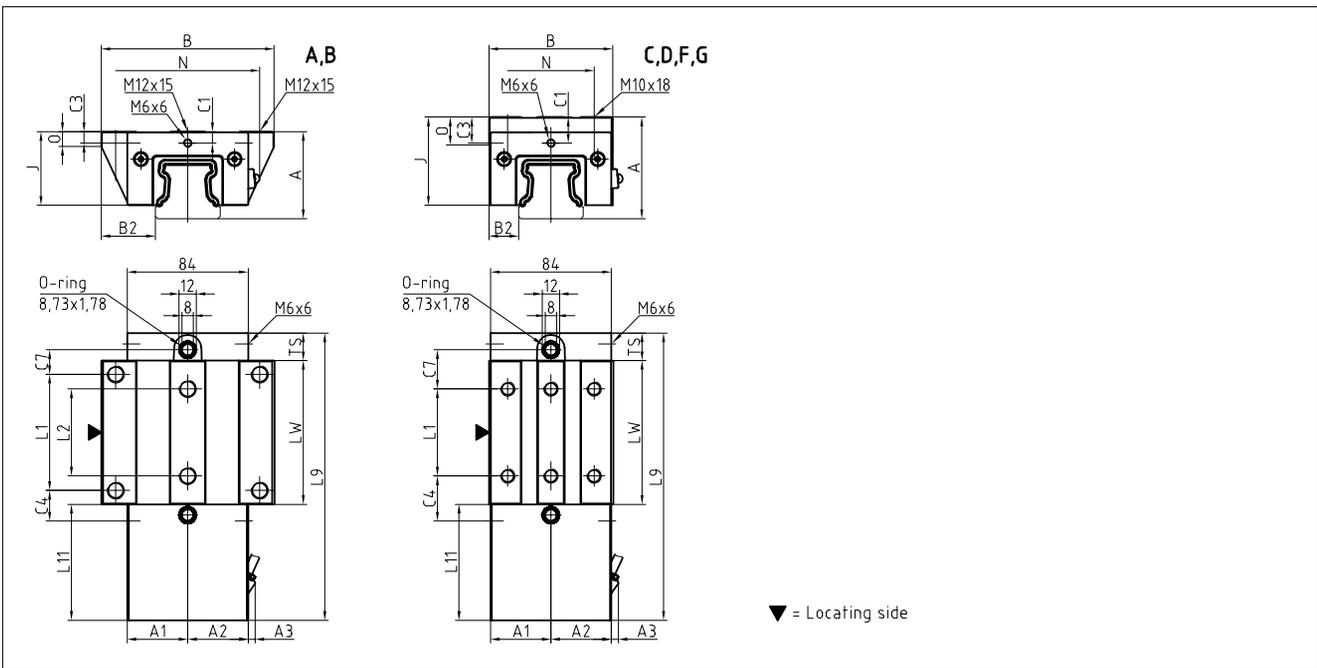

AMS 4B W 45 Rigidity diagram

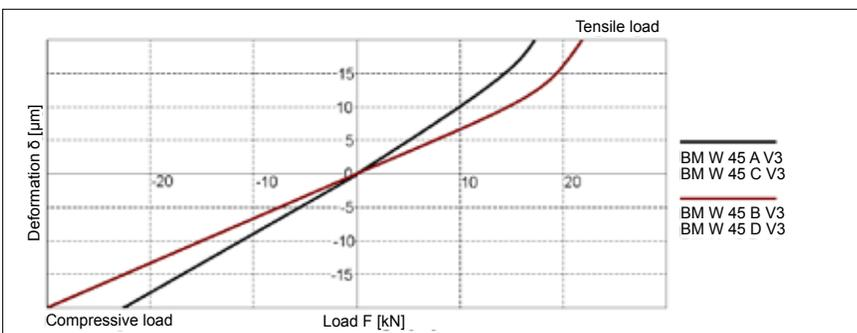

AMS 4B W 45 Load rating

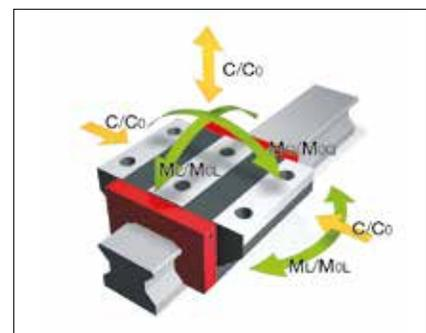

8.2 Technical data and options

AMS 4B Size 45

AMS 4B S 45 Dimensions

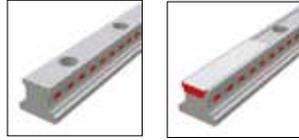

	AMS 4B S 45-N	AMS 4B S 45-C				
B1: Rail width	45	45				
J1: Rail height	37	37				
L3: Rail length max.	6000	6000				
L4: Spacing of fixing holes	105	105				
L5/L10: Position of first/last fixing hole	51	51				
Gew.: Rail weight, specific (kg/m)	8.8	8.6				

Available options for AMS 4B S 45



AMS 4B W 45 Dimensions and capacities

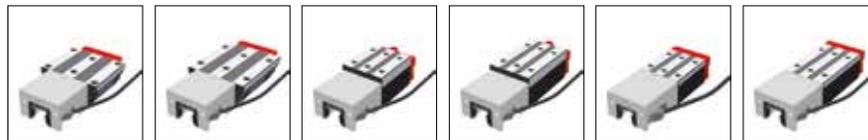

	AMS 4B W 45-A	AMS 4B W 45-B	AMS 4B W 45-C	AMS 4B W 45-D	AMS 4B W 45-F	AMS 4B W 45-G
A: System height	60	60	70	70	60	60
A1: Half width of housing on opposite side	42	42	42	42	42	42
A2: Half width of housing on reading head side	42	42	42	42	42	42
A3: Projection of reading head	5	5	5	5	5	5
B: Carriage width	120	120	86	86	86	86
B2: Distance between locating faces	37.5	37.5	20.5	20.5	20.5	20.5
C1: Position of center front lube hole	8	8	18	18	8	8
C3: Position of lateral lube hole	8	8	18	18	8	8
C4: Position of lateral lube hole	21.05	36.8	31.05	36.8	31.05	36.8
C7: Position of top lube hole	17.05	32.8	27.05	32.8	27.05	32.8
J: Carriage height	50.8	50.8	60.8	60.8	50.8	50.8
L1: Exterior fixing hole spacing	80	80	60	80	60	80
L2: Interior fixing hole spacing	60	60	-	-	-	-
L9: Carriage length with housing	198.1	229.6	198.1	229.6	198.1	229.6
L11: Housing length	80	80	80	80	80	80
Lw: Inner carriage body length	99.1	130.6	99.1	130.6	99.1	130.6
N: Lateral fixing hole spacing	100	100	60	60	60	60
O: Reference face height	10	10	19	19	10	10
Ts: Front plate thickness	19	19	19	19	19	19
Capacities and weights						
C0: Static load capacity (N)	134800	176300	134800	176300	134800	176300
C100: Dynamic load capacity (N)	61900	74700	61900	74700	61900	74700
MOQ: Static cross moment capacity (Nm)	3193	4175	3193	4175	3193	4175
MOL: Static longitud. moment capacity (Nm)	2498	4199	2498	4199	2498	4199
MQ: Dyn. cross moment capacity (Nm)	1466	1769	1466	1769	1466	1769
ML: Dyn. longitud. moment capacity (Nm)	1147	1779	1147	1779	1147	1779
Gew: Carriage weight (kg)	4.1	5.1	4.2	5.2	3.6	4.4

Available options for AMS 4B W 45



AMS 4B Rails accessories overview

Accessories	AMS 4B S 15	AMS 4B S 20	AMS 4B S 25	AMS 4B S 30	AMS 4B S 35	AMS 4B S 45	
Plugs:							
Plastic plugs	BRK 15	BRK 20	BRK 25	BRK 30	BRK 35	BRK 45	
Cover strips:							
Cover strip (spare part)	BAC 15	BAC 20	BAC 25	BAC 30	BAC 35	BAC 45	
End piece for cover strip (spare part)	EST 15-BAC	EST 20-BAC	EST 25-BAC	EST 30-BAC	EST 35-BAC	EST 45-BAC	
Assembly tools:							
Installation tool for cover strip	BWC 15	BWC 20	BWC 25	BWC 30	BWC 35	BWC 45	

AMS 4B Carriages accessories overview

Accessories	AMS 4B W 15	AMS 4B W 20	AMS 4B W 25	AMS 4B W 30	AMS 4B W 35	AMS 4B W 45	
Additional wipers:							
Additional wipers NBR	ZBN 15	ZBN 20	ZBN 25	ZBN 30	ZBN 35	ZBN 45	
Additional wipers Viton	ZBV 15	ZBV 20	ZBV 25	ZBV 30	ZBV 35	ZBV 45	
Metal wiper	ABM 15-A	ABM 20-A	ABM 25-A	ABM 30-A	ABM 35-A	ABM 45-A	
Bellows:							
Bellows	-	FBB 20	FBB 25	FBB 30	FBB 35	FBB 45	
Adapter plate for bellows (spare part)	-	ZPB 20	ZPB 25	ZPB 30	ZPB 35	ZPB 45	
End plate for bellows (spare part)	-	EPB 20	EPB 25	EPB 30	EPB 35	EPB 45	
Assembly rails:							
Assembly rail	MBM 15	MBM 20	MBM 25	MBM 30	MBM 35	MBM 45	
Lubrication plates:							
Lubrication plate	SPL 15-BM	SPL 20-BM	SPL 25-BM	SPL 30-BM	SPL 35-BM	SPL 45-BM	
Front plates:							
Cross wiper for front plate (spare part)	QAS 15-STB	QAS 20-STB	QAS 25-STB	QAS 30-STB	QAS 35-STB	QAS 45-STB	
Lube nipples:							
Hydraulic-type grease nipple straight	-	SN 6	SN 6	SN 6	SN 6	SN 6	
Hydraulic-type grease nipple 45°	-	SN 6-45	SN 6-45	SN 6-45	SN 6-45	SN 6-45	
Hydraulic-type grease nipple 90°	-	SN 6-90	SN 6-90	SN 6-90	SN 6-90	SN 6-90	
Flush type grease nipple M3	SN 3-T	SN 3-T	-	-	-	-	
Flush type grease nipple M6	-	SN 6-T	SN 6-T	SN 6-T	SN 6-T	SN 6-T	
Grease gun for SN 3-T und SN 6-T	SFP-T3	SFP-T3	SFP-T3	SFP-T3	SFP-T3	SFP-T3	
Lube adapters:							
Straight screw-in connection M3	SA 3-D3	SA 3-D3	-	-	-	-	
Lubrication adapter M8 round-head	-	SA 6-RD-M8	SA 6-RD-M8	SA 6-RD-M8	SA 6-RD-M8	SA 6-RD-M8	
Lubrication adapter M8 hexagon head	-	-	-	SA 6-6KT-M8	SA 6-6KT-M8	SA 6-6KT-M8	
Lubrication adapter G1/8 hexagon head	-	-	-	SA 6-6KT-G1/8	SA 6-6KT-G1/8	SA 6-6KT-G1/8	
Swivel screw connection for pipe d=4 mm	-	SV 6-D4	SV 6-D4	SV 6-D4	SV 6-D4	SV 6-D4	
Swivel screw connection M6	-	SV 6-M6	SV 6-M6	SV 6-M6	SV 6-M6	SV 6-M6	
Swivel screw connection M6 long	-	SV 6-M6-L	SV 6-M6-L	SV 6-M6-L	SV 6-M6-L	SV 6-M6-L	
Swivel screw connection M8	-	SV 6-M8	SV 6-M8	SV 6-M8	SV 6-M8	SV 6-M8	
Swivel screw connection M8 long	-	SV 6-M8-L	SV 6-M8-L	SV 6-M8-L	SV 6-M8-L	SV 6-M8-L	
Cables:							
Connecting cable, 12-pole	KAO 12-X	KAO 12-X	KAO 12-X	KAO 12-X	KAO 12-X	KAO 12-X	
Connecting cable, 12-pole	KAO 13-X	KAO 13-X	KAO 13-X	KAO 13-X	KAO 13-X	KAO 13-X	
Connecting cable, 12-pole	KAO 14-X	KAO 14-X	KAO 14-X	KAO 14-X	KAO 14-X	KAO 14-X	
Connecting cable, 12-pole	KAO 15-X	KAO 15-X	KAO 15-X	KAO 15-X	KAO 15-X	KAO 15-X	
Connecting cable, 12-pole	KAO 16-X	KAO 16-X	KAO 16-X	KAO 16-X	KAO 16-X	KAO 16-X	

8.4 Order key

Analog

Individual guide rails and carriages are ordered in accordance with the order codes described below.

AMS 4B carriages consist of guide carriage, casing and reading head.

All MONORAIL BM carriages can also be used with AMS 4B rails.

Q.v. chapter 2 and chapter 4.3 for the order key for accessories.

Separate order codes are used in each case for rails, carriages and accessories. This also applies to different versions of rails and carriages.

All guide components are supplied individually as standard, i.e. unassembled.

If required, SCHNEEBERGER can also supply rails and carriages assembled incl. accessories as complete systems. Please note the ordering instructions in chapter 2.4 if this applies.

The order code for the AMS 4B systems is made up of two groups. For the AMS system with an analog interface, the code is AMSA. The AMS system with a digital interface is referred to as AMSD.

Order code for AMSA 4B Rails

	1x	AMSA 4B S	25	-N	-G3	-KC	-R12	-958	-29	-29	-CN	-TR50
Quantity												
Rail												
Size												
Type												
Accuracy												
Straightness												
Reference side												
Rail length L3												
Position of first fixing hole L5												
Position of last fixing hole L10												
Coating												
Magnetization												

NB

Q.v. chapter 8.1 to 8.3 for an overview of types, details of shapes, available options and accessories.

Q.v. chapter 2 for a description of the options.

If possible, standard lengths are preferred for L3 rail length.

These are calculated with the table values in chapter 8.2 using the following formula: $L3 = n \times L4 + L5 + L10 \leq L3max$.

Order code for AMSA 4B Carriages

	1x	AMSA 4B W	25	-A	-P1	-G3	-V1	-R1	-CN	-S10	-LN	-TSU
Quantity												
Carriage												
Size												
Type												
Reading head position												
Accuracy												
Preload												
Reference side												
Coating												
Lube connection												
Lubrication as delivered condition												
Interface												

NB

Q.v. chapter 8.1 to 8.3 for an overview of types, details of shapes, available options and accessories.

Q.v. chapter 2 for a description of the options.

Order code for AMSD 4B Rails

	1x	AMSD 4B S	25	-N	-G3	-KC	-R12	-958	-29	-29	-CN	-TR50
Quantity												
Rail												
Size												
Type												
Accuracy												
Straightness												
Reference side												
Rail length L3												
Position of first fixing hole L5												
Position of last fixing hole L10												
Coating												
Magnetization												

NB

Q.v. chapter 8.1 to 8.3 for an overview of types, details of shapes, available options and accessories.

Q.v. chapter 2 for a description of the options.

If possible, standard lengths are preferred for L3 rail length.

These are calculated with the table values in chapter 8.2 using the following formula: $L3 = n \times L4 + L5 + L10 \leq L3max$.

Order code for AMSD 4B Carriages

	1x	AMSD 4B W	25	-A	-P1	-G3	-V1	-R1	-CN	-S10	-LN	-TSD	-050	-80	ZN
Quantity															
Carriage															
Size															
Type															
Reading head position															
Accuracy															
Preload															
Reference side															
Coating															
Lube connection															
Lubrication as delivered condition															
Interface															
Interpolation															
Frequency															
Reference pulse															

NB

Q.v. chapter 8.1 to 8.3 for an overview of types, details of shapes, available options and accessories.

Q.v. chapter 2 for a description of the options.

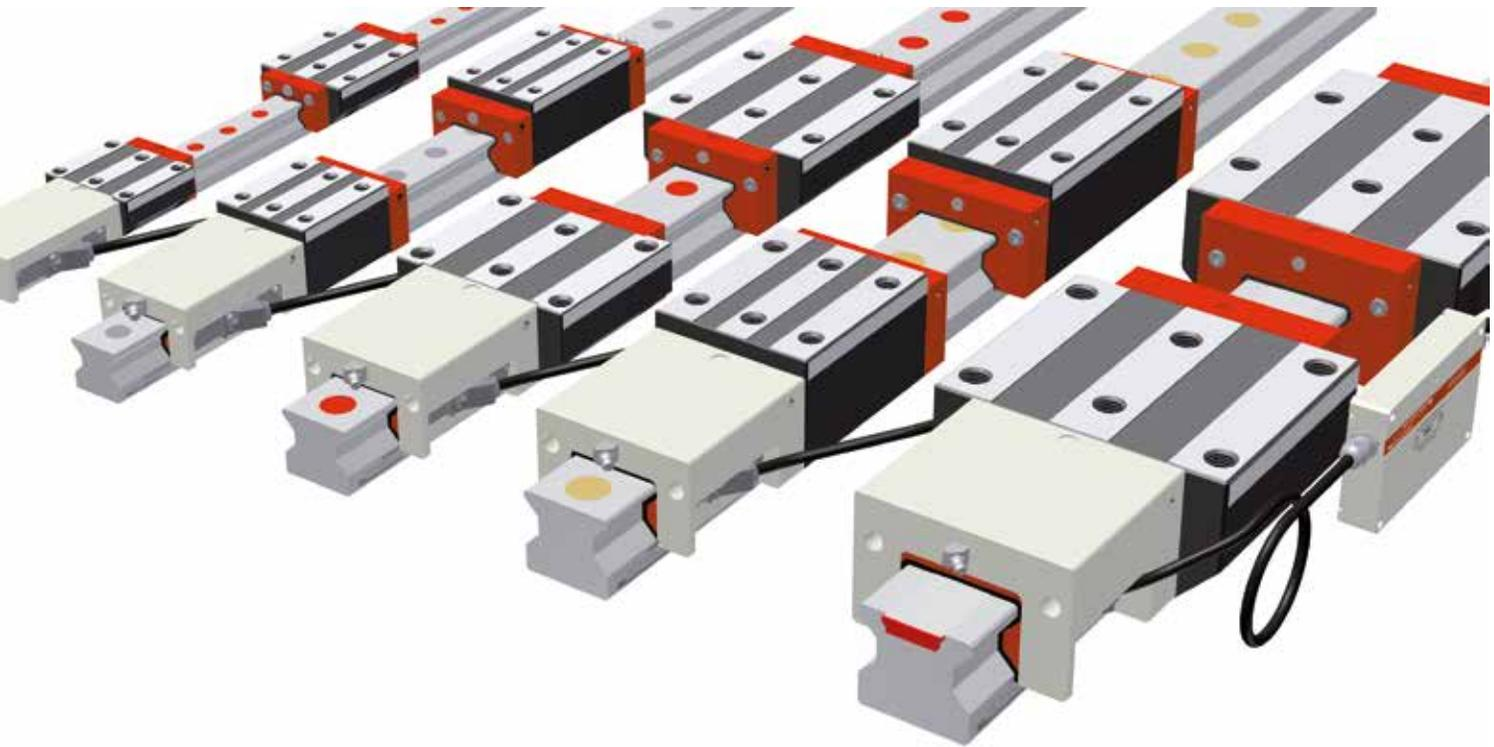

With the MONORAIL AMSABS 3B, SCHNEEBERGER provides an integrated measuring system for absolute distance measurement for use in automation engineering, mechanical handling technology and machine tool engineering, whereby high force absorption and precise distance measurements are required in small assembly spaces. From a mechanical point of view, the AMSABS 3B is based on the MONORAIL MR roller guide up to a length of 6m. The distance measurement system's compact housing facilitates the construction of highly compact axes. SCHNEEBERGER provides a fully digital interface with various cable lengths in order to connect it with the SSI, SSI+SinCos and FANUC control units. Various options regarding lubrication and sealing of the measuring carriages mean that optimal adjustments can be made to the requirements of the application. The easily exchangeable reading head is identical and replaceable for all sizes.

Features of System MONORAIL AMSABS 3B

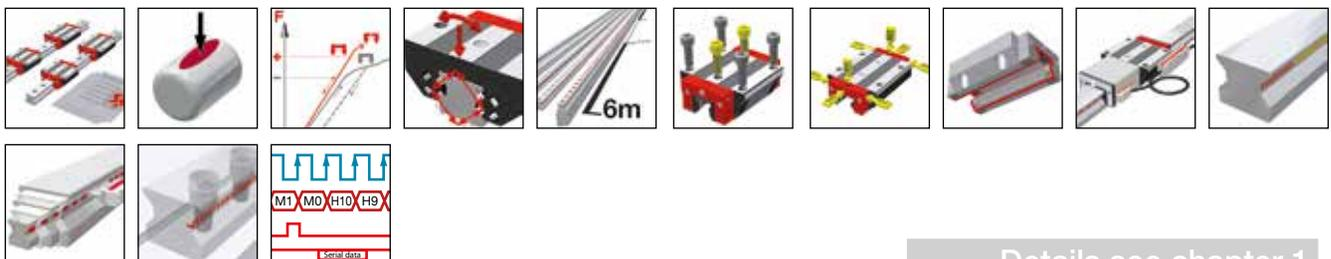

Details see chapter 1

9.1 Overview of types, sizes and available options



Product overview AMSABS 3B Rails	Page 156
Product overview AMSABS 3B Carriages	Page 157

9.2 Technical data and options

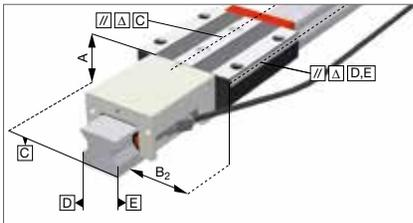

AMSABS 3B Size 25	Page 158
AMSABS 3B Size 35	Page 160
AMSABS 3B Size 45	Page 162
AMSABS 3B Size 55	Page 164
AMSABS 3B Size 65	Page 166

9.3 Accessories MONORAIL AMSABS 3B

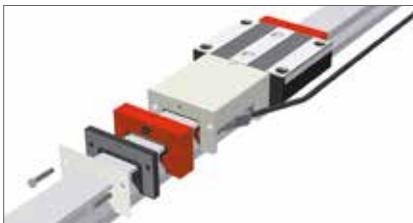

Accessories overview	Page 168
AMSABS 3B Rails accessory details	Page 53
AMSABS 3B Carriages accessory details	Page 56

9.4 Order key



Order key AMSABS 3B Rails	Page 169
Order key AMSABS 3B Carriages	Page 169

Product overview AMSABS 3B Rails



N
standard

NU
With tapped holes
at the bottom

C
for cover strip

Buildsizes / Rail build forms

	N	NU	C
Size 25	AMSABS 3B S 25-N	AMSABS 3B S 25-NU	AMSABS 3B S 25-C
Size 35	AMSABS 3B S 35-N	AMSABS 3B S 35-NU	AMSABS 3B S 35-C
Size 45	AMSABS 3B S 45-N	AMSABS 3B S 45-NU	AMSABS 3B S 45-C
Size 55	AMSABS 3B S 55-N	AMSABS 3B S 55-NU	AMSABS 3B S 55-C
Size 65	AMSABS 3B S 65-N	AMSABS 3B S 65-NU	AMSABS 3B S 65-C

Features

	N	NU	C
Screwable from above	●		●
Screwable from below		●	
Small assembly effort		●	●
Great single-part system length	●	●	●

Available options for AMSABS 3B Rails

Details see chapter 2

Accuracy

- G0 Highly accurate
- G1 Very accurate
- G2 Accurate
- G3 Standard

Straightness

- KC Standard

Coating

- CN None
- CH Hard chromium

Locating sides

- R11 Ref.bottom, scale bottom
- R12 Ref.bottom, scale top
- R21 Ref.top, scale bottom
- R22 Ref.top, scale top

Available accessories for AMSABS 3B Rails

Details see chapter 3.3

Plugs

Cover strips

Assembly tools

9.1 Overview of types, sizes and available options

AMSABS 3B Carriages

Product overview AMSABS 3B Carriages



	A standard	B standard, long	C compact, high	D compact, high, long		
Buildsizes / Carriage build forms						
Size 25	AMSABS 3B W 25-A	AMSABS 3B W 25-B	AMSABS 3B W 25-C	AMSABS 3B W 25-D		
Size 35	AMSABS 3B W 35-A	AMSABS 3B W 35-B	AMSABS 3B W 35-C	AMSABS 3B W 35-D		
Size 45	AMSABS 3B W 45-A	AMSABS 3B W 45-B	AMSABS 3B W 45-C	AMSABS 3B W 45-D		
Size 55	AMSABS 3B W 55-A	AMSABS 3B W 55-B	AMSABS 3B W 55-C	AMSABS 3B W 55-D		
Size 65	AMSABS 3B W 65-A	AMSABS 3B W 65-B	AMSABS 3B W 65-C	AMSABS 3B W 65-D		
Features						
Screwable from above	•	•	•	•		
Screwable from below	•	•				
For high loads and moments		•		•		
For medium loads and moments	•		•			

Available options for AMSABS 3B Carriages

Details see chapter 2

Accuracy

- G0 Highly accurate
- G1 Very accurate
- G2 Accurate
- G3 Standard

Preload

- V1 Low
- V2 Medium
- V3 High

Reference side

- R1 Ref. at bottom
- R2 Ref. on top

Coating

- CN None
- CH Hard chromium

Lube connections

- S10 Left center
- S20 Right center
- S11 Top left
- S21 Top right
- S12 Lower left side
- S22 Lower right side

- S13 Upper left side
- S23 Upper right side
- S32 Left side
- S42 Right side

Lubrication

- LN Oil protect
- LG Grease protect
- LV Full greasing

Interface

- TMH, absolute, 0.3m
- TRH, absolute, 3m

Reading head position

- P1 Right top
- P3 Left bottom

Available accessories for AMSABS 3B Carriages

Details see chapter 2.1 and 3.3

Additional wipers
Front plates

Bellows
Lube nipples

Assembly rails
Lube adapters

Lubrication plates
Cables

AMSABS 3B S 25 Drawings

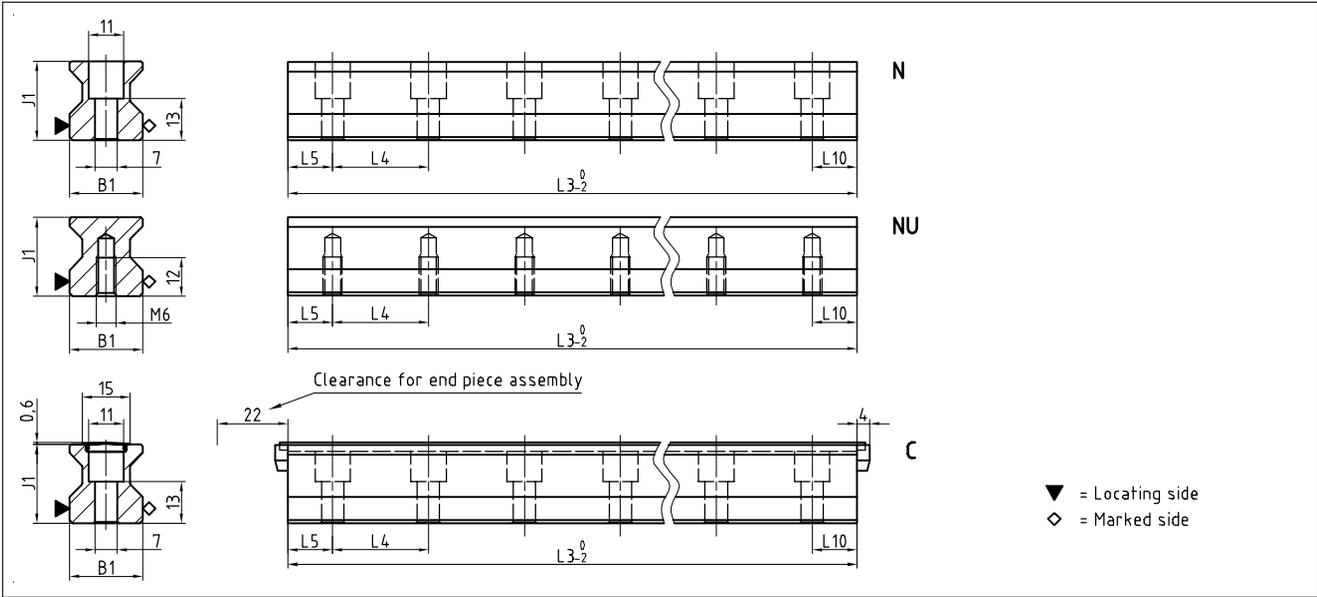

AMSABS 3B W 25 Drawings

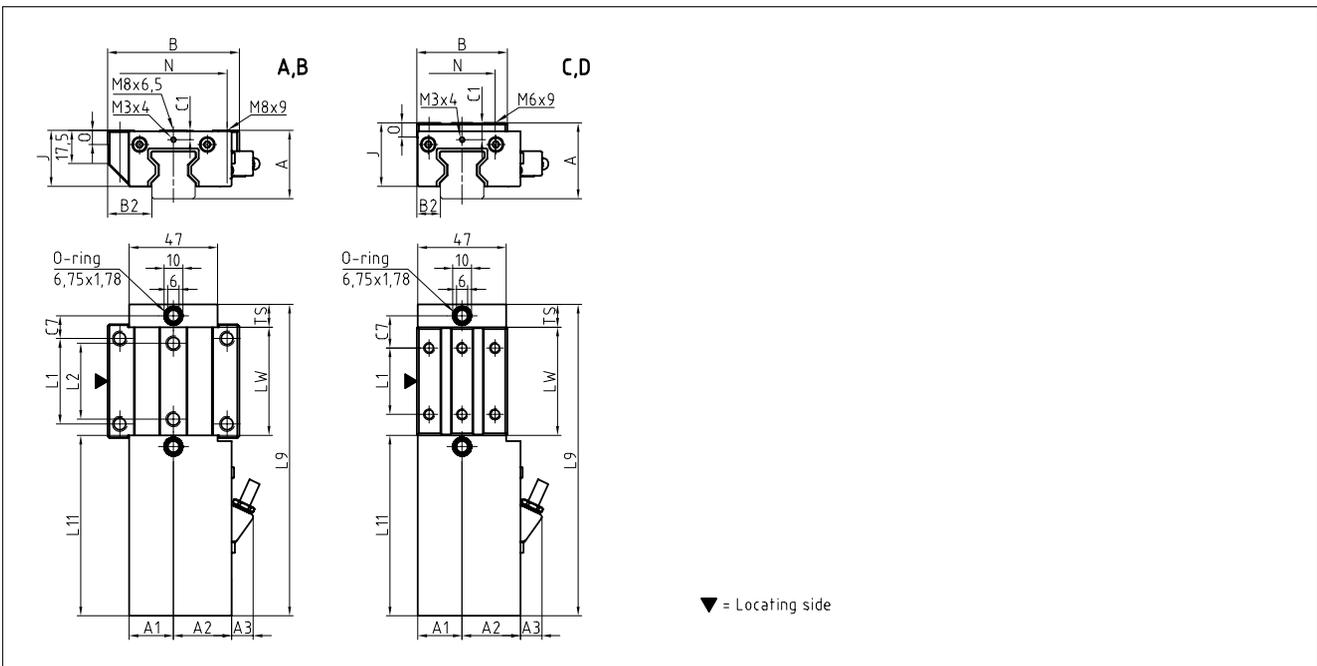

AMSABS 3B W 25 Rigidity diagram

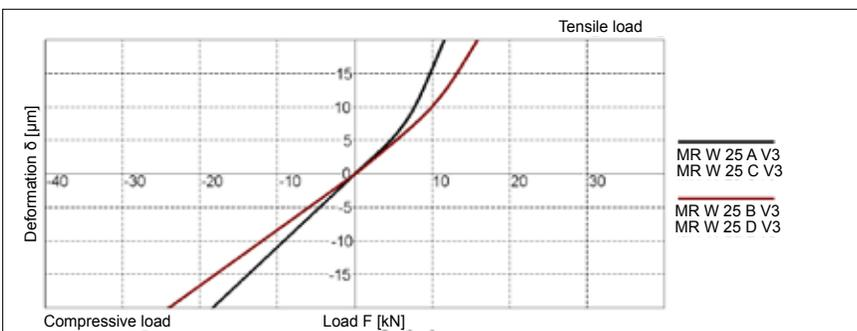

AMSABS 3B W 25 Load rating

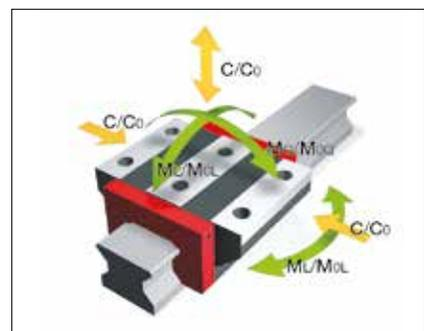

9.2 Technical data and options

AMSABS 3B Size 25

AMSABS 3B S 25 Dimensions



	AMSABS 3B S 25-N	AMSABS 3B S 25-NU	AMSABS 3B S 25-C			
B1: Rail width	23	23	23			
J1: Rail height	24.5	24.5	24.5			
L3: Rail length max.	6000	6000	3000			
L4: Spacing of fixing holes	30	30	30			
L5/L10: Position of first/last fixing hole	13.5	13.5	13.5			
Gew.: Rail weight, specific (kg/m)	3.4	3.8	3.3			

Available options for AMSABS 3B S 25



AMSABS 3B W 25 Dimensions and capacities

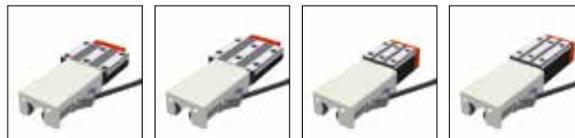

	AMSABS 3B W 25-A	AMSABS 3B W 25-B	AMSABS 3B W 25-C	AMSABS 3B W 25-D			
A: System height	36	36	40	40			
A1: Half width of housing on opposite side	23.5	23.5	23.5	23.5			
A2: Half width of housing on reading head side	31	31	31	31			
A3: Projection of reading head	11.5	11.5	11.5	11.5			
B: Carriage width	70	70	48	48			
B2: Distance between locating faces	23.5	23.5	12.5	12.5			
C1: Position of center front lube hole*	5 / 5.5	5 / 5.5	9 / 9.5	9 / 9.5			
C3: Position of lateral lube hole	-	-	-	-			
C4: Position of lateral lube hole	-	-	-	-			
C7: Position of top lube hole	12	23.2	17	20.7			
J: Carriage height	29.5	29.5	33.5	33.5			
L1: Exterior fixing hole spacing	45	45	35	50			
L2: Interior fixing hole spacing	40	40	-	-			
L9: Carriage length with housing	164.2	186.6	164.2	186.6			
L11: Housing length	95.2	95.2	95.2	95.2			
Lw: Inner carriage body length	57	79.4	57	79.4			
N: Lateral fixing hole spacing	57	57	35	35			
O: Reference face height	7.5	7.5	7.5	7.5			
Ts: Front plate thickness	12	12	12	12			
Capacities and weights							
C0: Static load capacity (N)	49800	70300	49800	70300			
C100: Dynamic load capacity (N)	27700	39100	27700	39100			
MOQ: Static cross moment capacity (Nm)	733	1035	733	1035			
MOL: Static longitud. moment capacity (Nm)	476	936	476	936			
MQ: Dyn. cross moment capacity (Nm)	408	576	408	576			
ML: Dyn. longitud. moment capacity (Nm)	265	521	265	521			
Gew: Carriage weight (kg)	1.0	1.2	0.9	1.0			

Note: * Values valid for external housing / front plate

Available options for AMSABS 3B W 25



AMSABS 3B S 35 Drawings

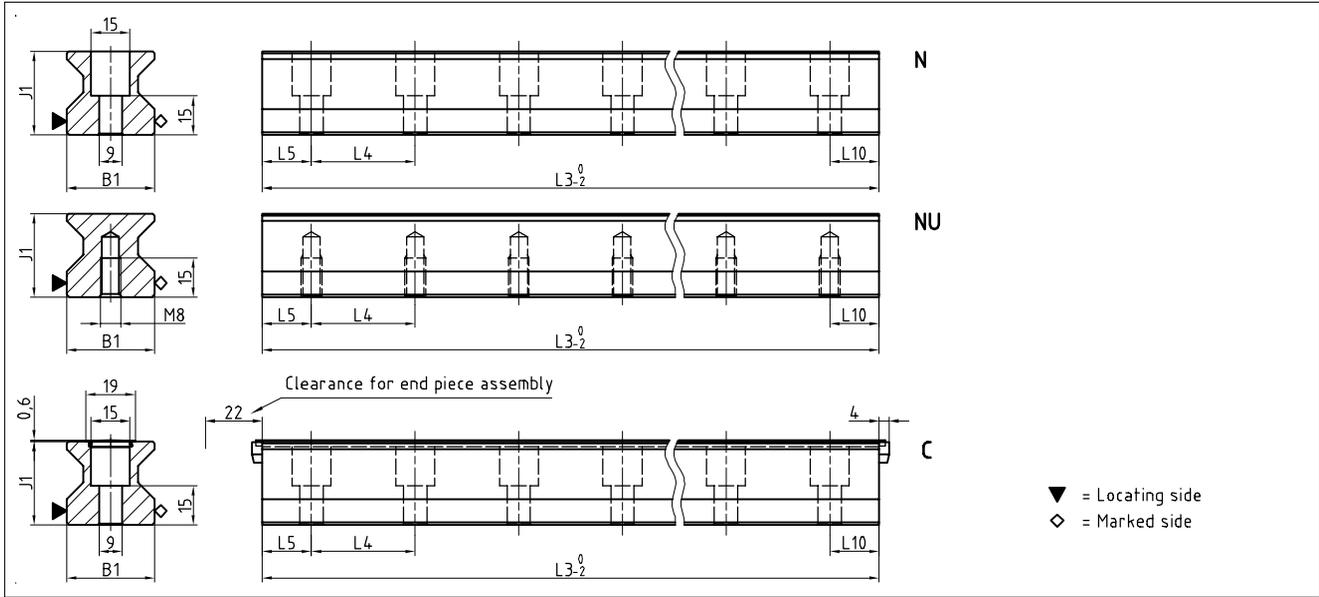

AMSABS 3B W 35 Drawings

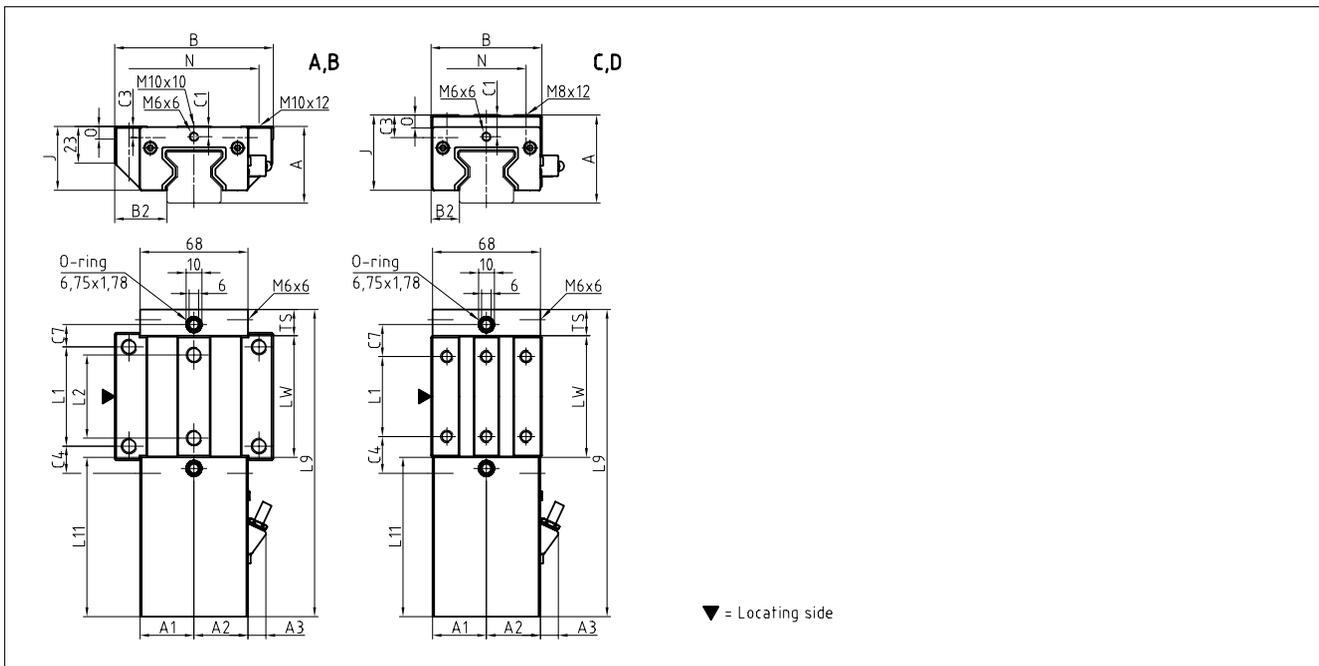

AMSABS 3B W 35 Rigidity diagram

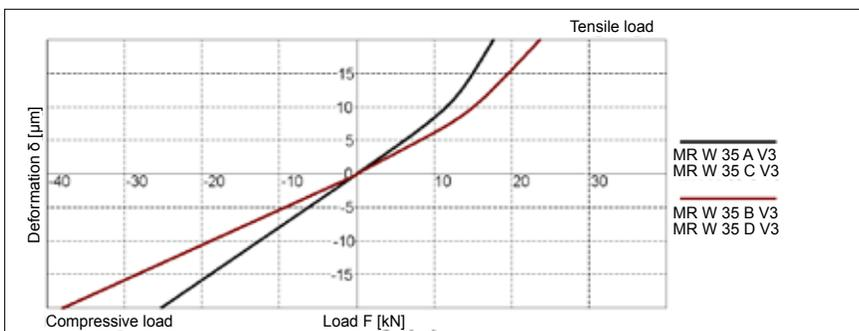

AMSABS 3B W 35 Load rating

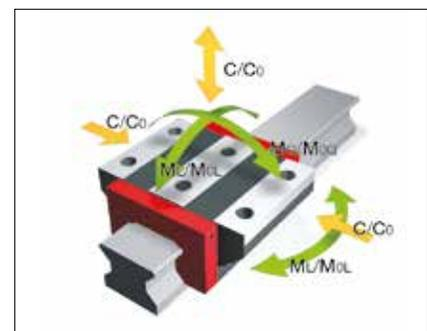

9.2 Technical data and options

AMSABS 3B Size 35

AMSABS 3B S 35 Dimensions



	AMSABS 3B S 35-N	AMSABS 3B S 35-NU	AMSABS 3B S 35-C			
B1: Rail width	34	34	34			
J1: Rail height	32	32	32			
L3: Rail length max.	6000	6000	6000			
L4: Spacing of fixing holes	40	40	40			
L5/L10: Position of first/last fixing hole	18.5	18.5	18.5			
Gew.: Rail weight, specific (kg/m)	6.5	7.1	6.3			

Available options for AMSABS 3B S 35



AMSABS 3B W 35 Dimensions and capacities

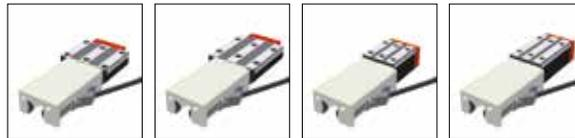

	AMSABS 3B W 35-A	AMSABS 3B W 35-B	AMSABS 3B W 35-C	AMSABS 3B W 35-D			
A: System height	48	48	55	55			
A1: Half width of housing on opposite side	34	34	34	34			
A2: Half width of housing on reading head side	34	34	34	34			
A3: Projection of reading head	11.5	11.5	11.5	11.5			
B: Carriage width	100	100	70	70			
B2: Distance between locating faces	33	33	18	18			
C1: Position of center front lube hole*	6.5 / 7	6.5 / 7	13.5 / 14	13.5 / 14			
C3: Position of lateral lube hole	7	7	14	14			
C4: Position of lateral lube hole	17	30.5	23	25.5			
C7: Position of top lube hole	14	27.5	20	22.5			
J: Carriage height	40	40	47	47			
L1: Exterior fixing hole spacing	62	62	50	72			
L2: Interior fixing hole spacing	52	52	-	-			
L9: Carriage length with housing	192.2	219.2	192.2	219.2			
L11: Housing length	99.7	99.7	99.7	99.7			
Lw: Inner carriage body length	76	103	76	103			
N: Lateral fixing hole spacing	82	82	50	50			
O: Reference face height	8	8	8	8			
Ts: Front plate thickness	16.5	16.5	16.5	16.5			

Capacities and weights

C0: Static load capacity (N)	93400	128500	93400	128500			
C100: Dynamic load capacity (N)	52000	71500	52000	71500			
MOQ: Static cross moment capacity (Nm)	2008	2762	2008	2762			
MOL: Static longitud. moment capacity (Nm)	1189	2214	1189	2214			
MQ: Dyn. cross moment capacity (Nm)	1118	1537	1118	1537			
ML: Dyn. longitud. moment capacity (Nm)	662	1232	662	1232			
Gew: Carriage weight (kg)	2.0	2.6	1.9	2.4			

Note: * Values valid for external housing / front plate

Available options for AMSABS 3B W 35



AMSABS 3B S 45 Drawings

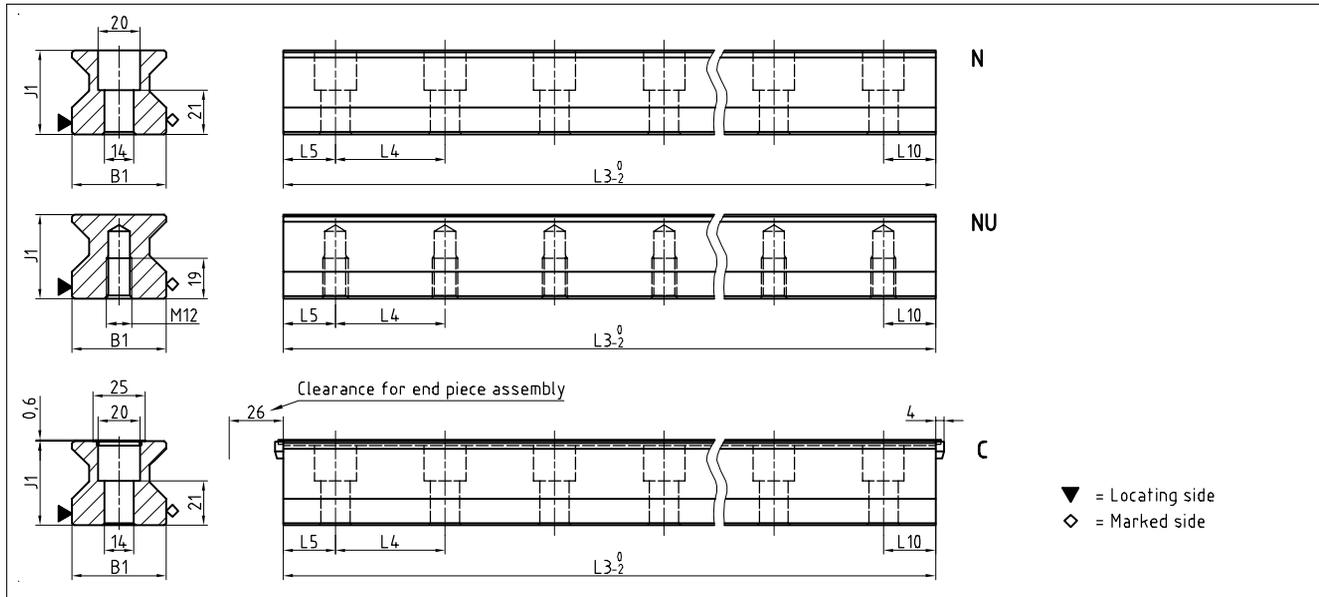

AMSABS 3B W 45 Drawings

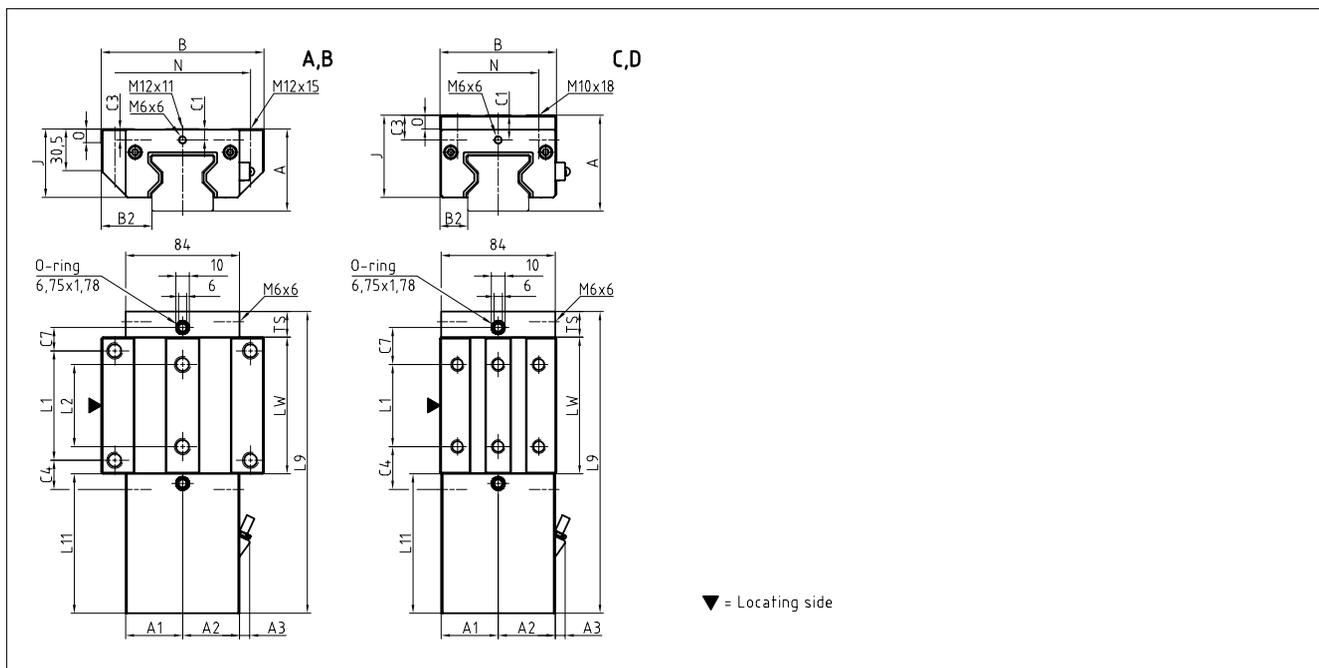

AMSABS 3B W 45 Rigidity diagram

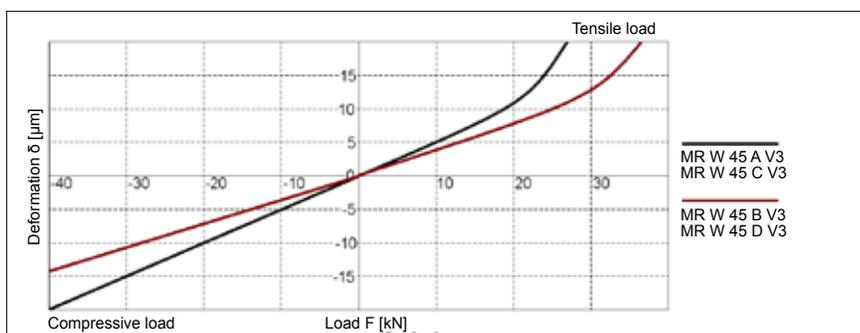

AMSABS 3B W 45 Load rating

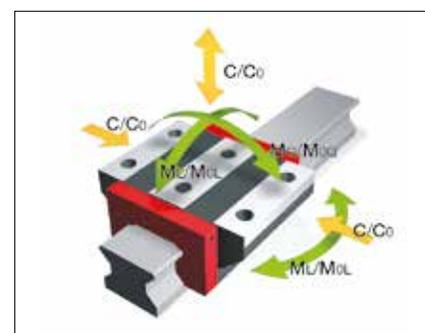

9.2 Technical data and options

AMSABS 3B Size 45

AMSABS 3B S 45 Dimensions

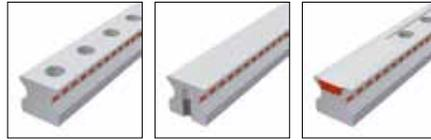

	AMSABS 3B S 45-N	AMSABS 3B S 45-NU	AMSABS 3B S 45-C			
B1: Rail width	45	45	45			
J1: Rail height	40	40	40			
L3: Rail length max.	6000	6000	6000			
L4: Spacing of fixing holes	52.5	52.5	52.5			
L5/L10: Position of first/last fixing hole	25	25	25			
Gew.: Rail weight, specific (kg/m)	10.8	11.8	10.6			

Available options for AMSABS 3B S 45



AMSABS 3B W 45 Dimensions and capacities

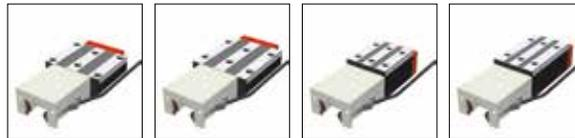

	AMSABS 3B W 45-A	AMSABS 3B W 45-B	AMSABS 3B W 45-C	AMSABS 3B W 45-D			
A: System height	60	60	70	70			
A1: Half width of housing on opposite side	42	42	42	42			
A2: Half width of housing on reading head side	42	42	42	42			
A3: Projection of reading head	7.5	7.5	7.5	7.5			
B: Carriage width	120	120	86	86			
B2: Distance between locating faces	37.5	37.5	20.5	20.5			
C1: Position of center front lube hole	8	8	18	18			
C3: Position of lateral lube hole	8	8	18	18			
C4: Position of lateral lube hole	21.25	38.75	31.25	38.75			
C7: Position of top lube hole	17	34.5	27	34.5			
J: Carriage height	50	50	60	60			
L1: Exterior fixing hole spacing	80	80	60	80			
L2: Interior fixing hole spacing	60	60	-	-			
L9: Carriage length with housing	220.7	255.7	220.7	255.7			
L11: Housing length	101.9	101.9	101.9	101.9			
Lw: Inner carriage body length	100	135	100	135			
N: Lateral fixing hole spacing	100	100	60	60			
O: Reference face height	10	10	10	10			
Ts: Front plate thickness	18.8	18.8	18.8	18.8			

Capacities and weights

C0: Static load capacity (N)	167500	229500	167500	229500			
C100: Dynamic load capacity (N)	93400	127800	93400	127800			
MOQ: Static cross moment capacity (Nm)	4621	6333	4621	6333			
MOL: Static longitud. moment capacity (Nm)	2790	5161	2790	5161			
MQ: Dyn. cross moment capacity (Nm)	2577	3527	2577	3527			
ML: Dyn. longitud. moment capacity (Nm)	1556	2874	1556	2874			
Gew: Carriage weight (kg)	3.8	4.9	3.6	4.6			

Available options for AMSABS 3B W 45



AMSABS 3B S 55 Drawings

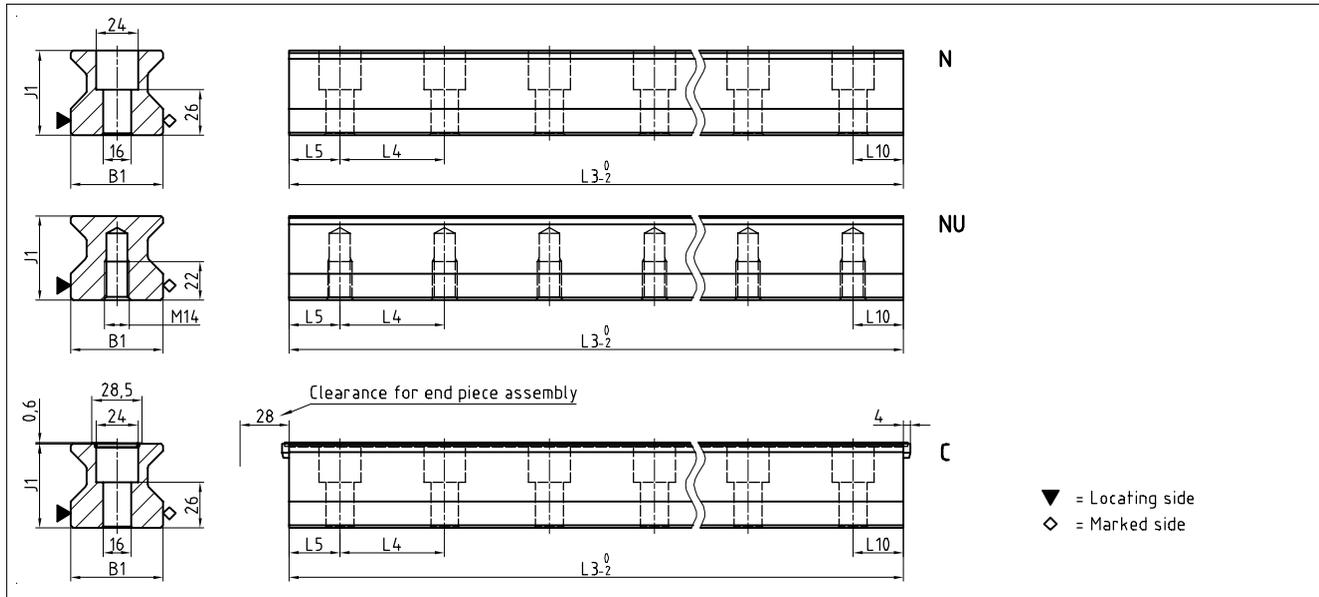

AMSABS 3B W 55 Drawings

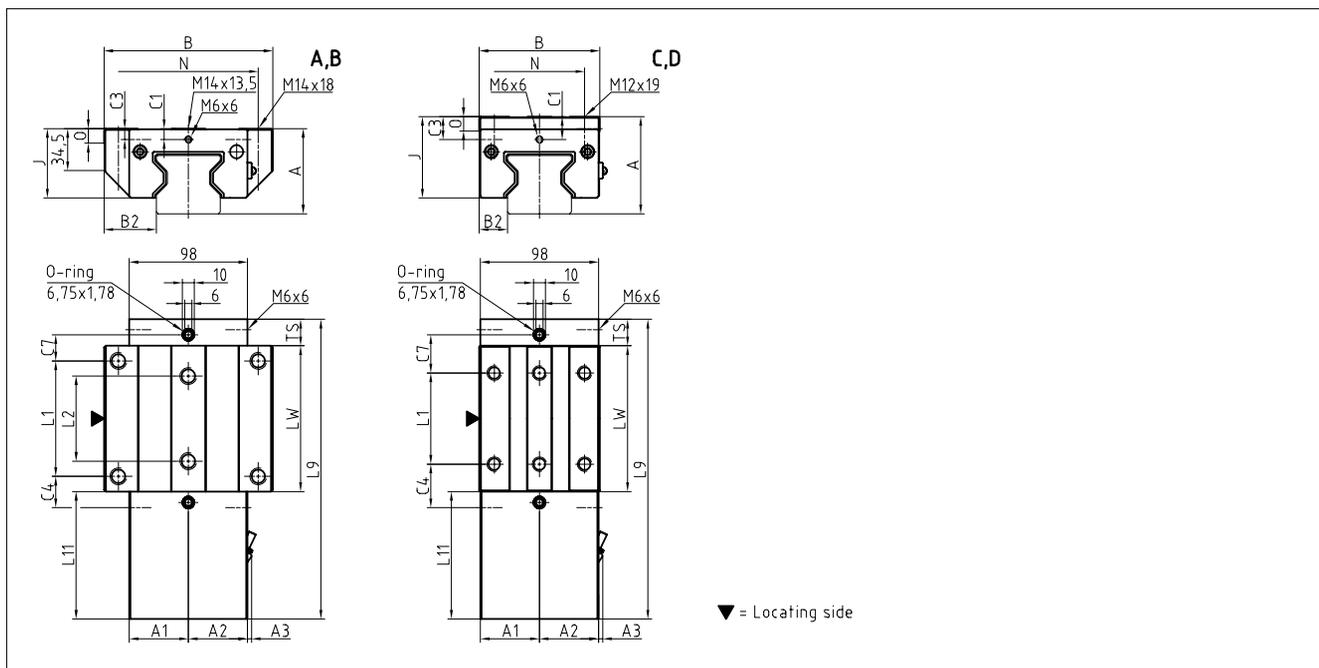

AMSABS 3B W 55 Rigidity diagram

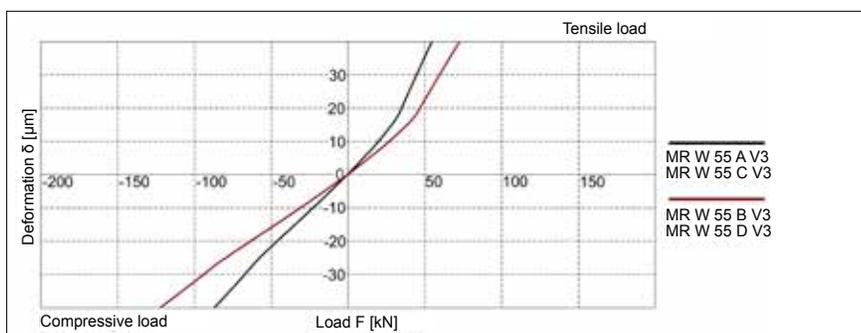

AMSABS 3B W 55 Load rating

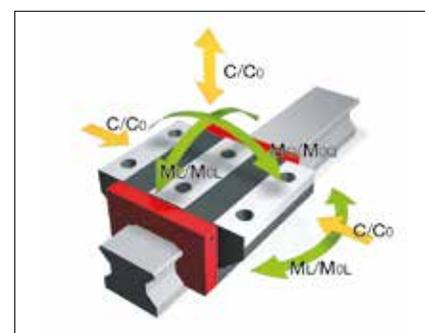

9.2 Technical data and options

AMSABS 3B Size 55

AMSABS 3B S 55 Dimensions



	AMSABS 3B S 55-N	AMSABS 3B S 55-NU	AMSABS 3B S 55-C			
B1: Rail width	53	53	53			
J1: Rail height	48	48	48			
L3: Rail length max.	6000	6000	6000			
L4: Spacing of fixing holes	60	60	60			
L5/L10: Position of first/last fixing hole	28.5	28.5	28.5			
Gew.: Rail weight, specific (kg/m)	15.2	16.6	14.9			

Available options for AMSABS 3B S 55



AMSABS 3B W 55 Dimensions and capacities



	AMSABS 3B W 55-A	AMSABS 3B W 55-B	AMSABS 3B W 55-C	AMSABS 3B W 55-D			
A: System height	70	70	80	80			
A1: Half width of housing on opposite side	49	49	49	49			
A2: Half width of housing on reading head side	49	49	49	49			
A3: Projection of reading head	3.5	3.5	3.5	3.5			
B: Carriage width	140	140	100	100			
B2: Distance between locating faces	43.5	43.5	23.5	23.5			
C1: Position of center front lube hole	9	9	19	19			
C3: Position of lateral lube hole	9	9	19	19			
C4: Position of lateral lube hole	25.75	46.75	35.75	46.75			
C7: Position of top lube hole	21.5	42.5	31.5	42.5			
J: Carriage height	57	57	67	67			
L1: Exterior fixing hole spacing	95	95	75	95			
L2: Interior fixing hole spacing	70	70	-	-			
L9: Carriage length with housing	246.7	288.7	246.7	288.7			
L11: Housing length	104.9	104.9	104.9	104.9			
Lw: Inner carriage body length	120	162	120	162			
N: Lateral fixing hole spacing	116	116	75	75			
O: Reference face height	12	12	12	12			
Ts: Front plate thickness	21.8	21.8	21.8	21.8			

Capacities and weights

C0: Static load capacity (N)	237000	324000	237000	324000			
C100: Dynamic load capacity (N)	131900	180500	131900	180500			
MOQ: Static cross moment capacity (Nm)	7771	10624	7771	10624			
MOL: Static longitud. moment capacity (Nm)	4738	8745	4738	8745			
MQ: Dyn. cross moment capacity (Nm)	4325	5919	4325	5919			
ML: Dyn. longitud. moment capacity (Nm)	2637	4872	2637	4872			
Gew: Carriage weight (kg)	5.8	7.6	5.3	6.9			

Available options for AMSABS 3B W 55



AMSABS 3B S 65 Drawings

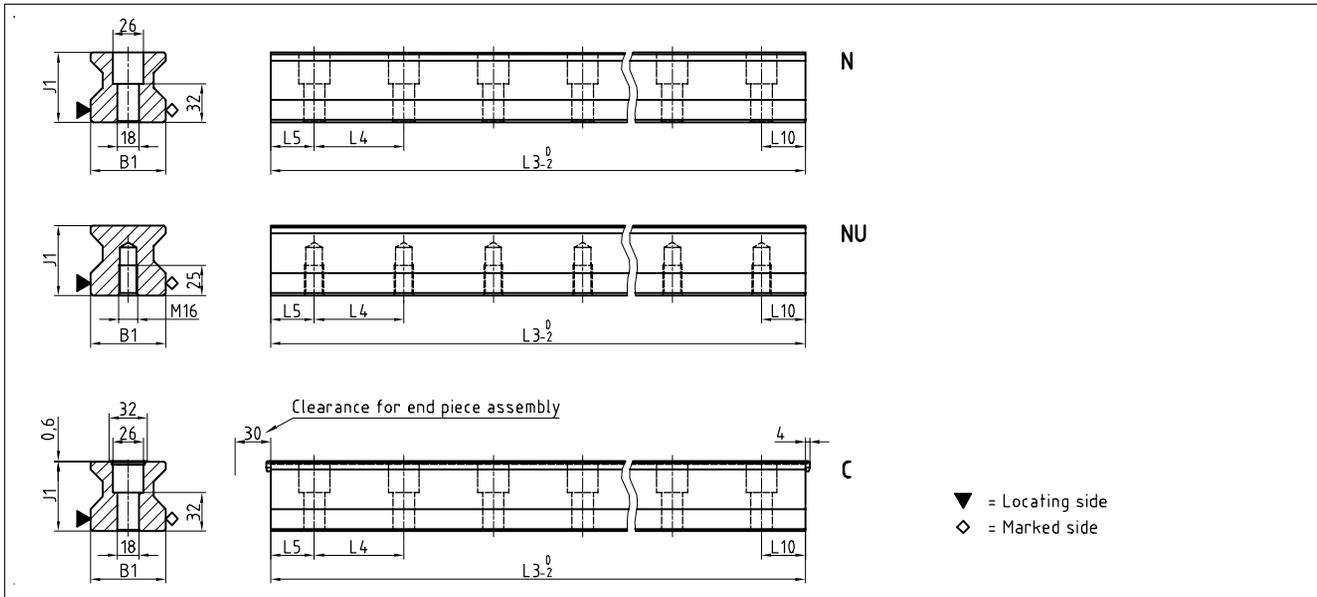

AMSABS 3B W 65 Drawings

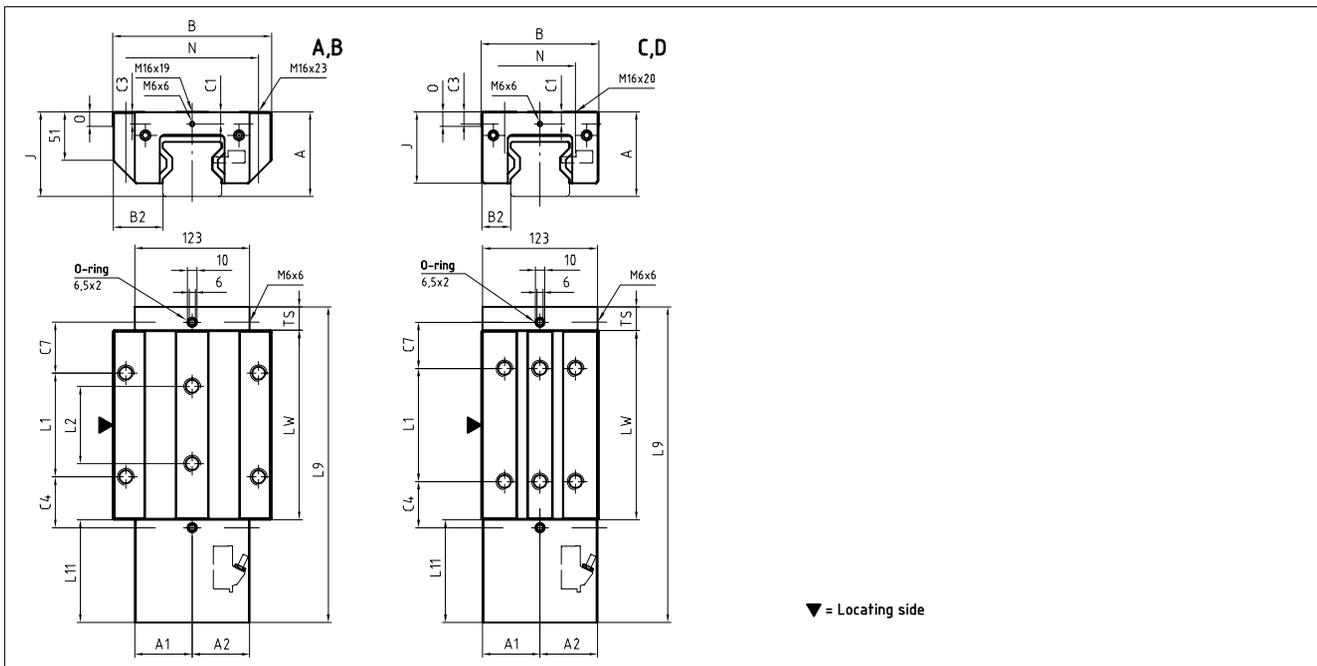

AMSABS 3B W 65 Rigidity diagram

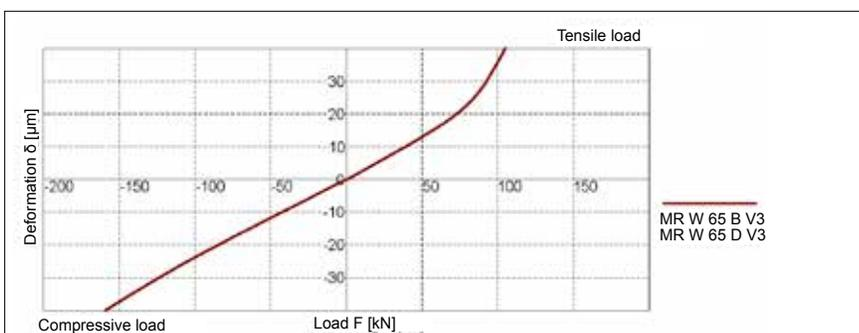

AMSABS 3B W 65 Load rating

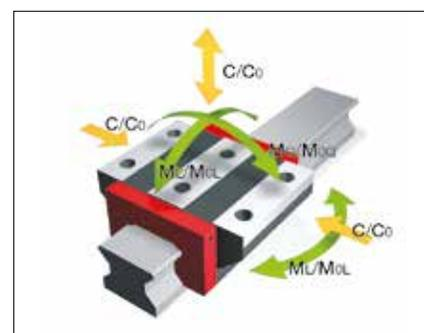

9.2 Technical data and options

AMSABS 3B Size 65

AMSABS 3B S 65 Dimensions



	AMSABS 3B S 65-N	AMSABS 3B S 65-NU	AMSABS 3B S 65-C			
B1: Rail width	63	63	63			
J1: Rail height	58	58	58			
L3: Rail length max.	6000	6000	6000			
L4: Spacing of fixing holes	75	75	75			
L5/L10: Position of first/last fixing hole	36	36	36			
Gew.: Rail weight, specific (kg/m)	22.8	24.5	22.5			

Available options for AMSABS 3B S 65



AMSABS 3B W 65 Dimensions and capacities



	AMSABS 3B W 65-A	AMSABS 3B W 65-B	AMSABS 3B W 65-C	AMSABS 3B W 65-D			
A: System height	90	90	90	90			
A1: Half width of housing on opposite side	61.5	61.5	61.5	61.5			
A2: Half width of housing on reading head side	61.5	61.5	61.5	61.5			
A3: Projection of reading head	0	0	0	0			
B: Carriage width	170	170	126	126			
B2: Distance between locating faces	53.5	53.5	31.5	31.5			
C1: Position of center front lube hole	13	13	13	13			
C3: Position of lateral lube hole	13	13	13	13			
C4: Position of lateral lube hole	31.75	58	51.75	53			
C7: Position of top lube hole	27.75	54	47.75	49			
J: Carriage height	76	76	76	76			
L1: Exterior fixing hole spacing	110	110	70	120			
L2: Interior fixing hole spacing	82	82	-	-			
L9: Carriage length with housing	282.5	335	282.5	335			
L11: Housing length	109	109	109	109			
Lw: Inner carriage body length	148.5	201	148.5	201			
N: Lateral fixing hole spacing	142	142	76	76			
O: Reference face height	15	15	15	15			
Ts: Front plate thickness	25	25	25	25			

Capacities and weights

C0: Static load capacity (N)	419 000	530 000	419 000	530 000			
C100: Dynamic load capacity (N)	232 000	295 000	232 000	295 000			
MOQ: Static cross moment capacity (Nm)	16 446	20 912	16 446	20 912			
MOL: Static longitud. moment capacity (Nm)	10 754	17 930	10 754	17 930			
MQ: Dyn. cross moment capacity (Nm)	9 154	11 640	9 154	11 640			
ML: Dyn. longitud. moment capacity (Nm)	5 954	9 980	5 954	9 980			
Gew: Carriage weight (kg)	11.6	14.9	9.3	11.8			

Available options for AMSABS 3B W 65



AMSABS 3B Rails accessories overview

Accessories	AMSABS 3B S 25	AMSABS 3B S 35	AMSABS 3B S 45	AMSABS 3B S 55	AMSABS 3B S 65
Plugs:					
Plastic plugs	MRK 25	MRK 35	MRK 45	MRK 55	MRK 65
Brass plugs	MRS 25	MRS 35	MRS 45	MRS 55	MRS 65
Steel plugs	MRZ 25	MRZ 35	MRZ 45	MRZ 55	MRZ 65
Cover strips:					
Cover strip (spare part)	MAC 25	MAC 35	MAC 45	MAC 55	MAC 65
End piece for cover strip (spare part)	EST 25-MAC	EST 35-MAC	EST 45-MAC	EST 55-MAC	EST 65-MAC
Securing band for cover strip (spare part)	BSC 25-MAC	BSC 35-MAC	BSC 45-MAC	BSC 55-MAC	BSC 65-MAC
Assembly tools:					
Installation tool for steel plugs	MWH 25	MWH 35	MWH 45	MWH 55	MWH 65
Hydraulic cylinder for MWH	MZH	MZH	MZH	MZH	MZH
Installation tool for cover strip	MWC 25	MWC 35	MWC 45	MWC 55	MWC 65

AMSABS 3B Carriages accessories overview

Accessories	AMSABS 3B W 25	AMSABS 3B W 35	AMSABS 3B W 45	AMSABS 3B W 55	AMSABS 3B W 65
Additional wipers:					
Additional wipers NBR	ZCN 25	ZCN 35	ZCN 45	ZCN 55	ZCN 65
Additional wipers Viton	ZCV 25	ZCV 35	ZCV 45	ZCV 55	ZCV 65
Metal wiper	ASM 25-A	ASM 35-A	ASM 45-A	ASM 55-A	ASM 65-A
Bellows:					
Bellows	FBM 25	FBM 35	FBM 45	FBM 55	FBM 65
Adapter plate for bellows (spare part)	ZPL 25	ZPL 35	ZPL 45	ZPL 55	ZPL 65
End plate for bellows (spare part)	EPL 25	EPL 35	EPL 45	EPL 55	EPL 65
Assembly rails:					
Assembly rail	MRM 25	MRM 35	MRM 45	MRM 55	MRM 65
Lubrication plates:					
Lubrication plate	SPL 25-MR	SPL 35-MR	SPL 45-MR	SPL 55-MR	SPL 65-MR
Front plates:					
Front plate (spare part)	STP 25-EK	STP 35-EK	STP 45-EK	STP 55-EK	STP 65-EK
Lube nipples:					
Hydraulic-type grease nipple straight	SN 6	SN 6	SN 6	SN 6	SN 6
Hydraulic-type grease nipple 45°	SN 6-45	SN 6-45	SN 6-45	SN 6-45	SN 6-45
Hydraulic-type grease nipple 90°	SN 6-90	SN 6-90	SN 6-90	SN 6-90	SN 6-90
Flush type grease nipple M3	SN 3-T	-	-	-	-
Flush type grease nipple M6	SN 6-T	SN 6-T	SN 6-T	SN 6-T	SN 6-T
Grease gun for SN 3-T und SN 6-T	SFP-T3	SFP-T3	SFP-T3	SFP-T3	SFP-T3
Lube adapters:					
Straight screw-in connection M3	SA 3-D3	-	-	-	-
Lubrication adapter M8 round-head	SA 6-RD-M8	SA 6-RD-M8	SA 6-RD-M8	SA 6-RD-M8	SA 6-RD-M8
Lubrication adapter M8 hexagon head	-	SA 6-6KT-M8	SA 6-6KT-M8	SA 6-6KT-M8	SA 6-6KT-M8
Lubrication adapter G1/8 hexagon head	-	SA 6-6KT-G1/8	SA 6-6KT-G1/8	SA 6-6KT-G1/8	SA 6-6KT-G1/8
Swivel screw connection for pipe d=4 mm	SV 6-D4	SV 6-D4	SV 6-D4	SV 6-D4	SV 6-D4
Swivel screw connection M6	SV 6-M6	SV 6-M6	SV 6-M6	SV 6-M6	SV 6-M6
Swivel screw connection M6 long	SV 6-M6-L	SV 6-M6-L	SV 6-M6-L	SV 6-M6-L	SV 6-M6-L
Swivel screw connection M8	SV 6-M8	SV 6-M8	SV 6-M8	SV 6-M8	SV 6-M8
Swivel screw connection M8 long	SV 6-M8-L	SV 6-M8-L	SV 6-M8-L	SV 6-M8-L	SV 6-M8-L

9.4 Order key

Individual guide rails and carriages are ordered in accordance with the order codes described below.

AMSABS 3B carriages consist of guide carriage, casing and reading head.

All MONORAIL MR carriages can also be used with AMSABS 3B rails.

Q.v. chapter 2 and chapter 3.3 for the order key for accessories.

Separate order codes are used in each case for rails, carriages and accessories. This also applies to different versions of rails and carriages.

All guide components are supplied individually as standard, i.e. unassembled.

If required, SCHNEEBERGER can also supply rails and carriages assembled incl. accessories as complete systems. Please note the ordering instructions in chapter 2.4 if this applies.

Order code for AMSABS 3B Rails

	1x	AMSABS 3B S	35	-C	-G1	-KC	-R11	-2936	-28	-28	-CN	-TA1
Quantity												
Rail												
Size												
Type												
Accuracy												
Straightness												
Reference side												
Rail length L3												
Position of first fixing hole L5												
Position of last fixing hole L10												
Coating												
Type of magnetisation												

NB

Q.v. chapter 9.1 to 9.3 for an overview of types, details of shapes, available options and accessories.

Q.v. chapter 2 for a description of the options.

If possible, standard lengths are preferred for L3 rail length.

These are calculated with the table values in chapter 9.2 using the following formula: $L3 = n \times L4 + L5 + L10 \leq L3max$.

Order code for AMSABS 3B Carriages

	1x	AMSABS 3B W	35	-B	-P1	-G1	-V3	-R2	-CN	-S12	-LN	-TSH
Quantity												
Carriage												
Size												
Type												
Reading head position												
Accuracy												
Preload												
Reference side												
Coating												
Lube connection												
Lubrication as delivered condition												
Interface												

NB

Q.v. chapter 9.1 to 9.3 for an overview of types, details of shapes, available options and accessories.

Q.v. chapter 2 for a description of the options.

For detailed information about current configuration options for the interfaces, please visit our website at www.schneeberger.com.

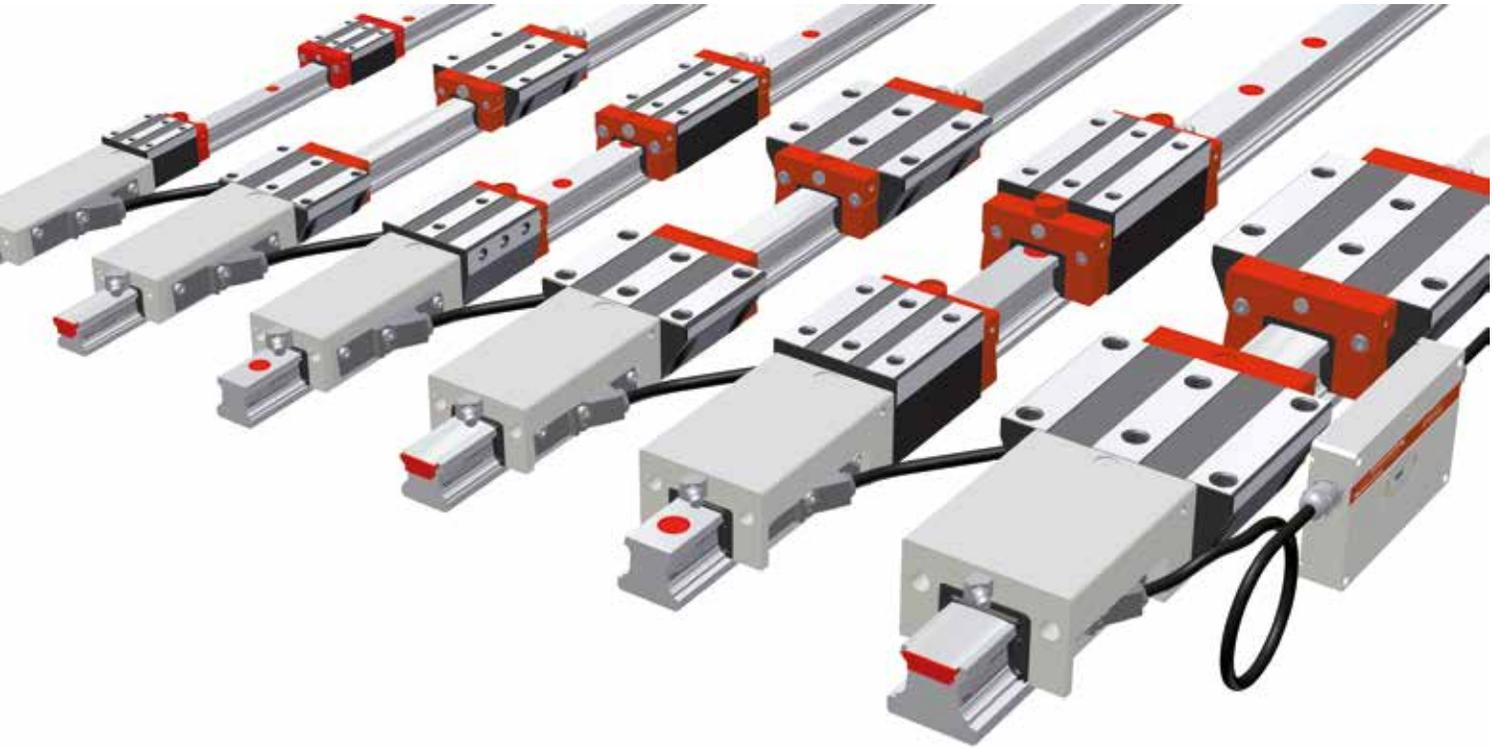

With the MONORAIL AMSABS 4B, SCHNEEBERGER provides an integrated measuring system for absolute distance measurement for use in automation engineering, mechanical handling technology and machine tool engineering, whereby high force absorption and precise distance measurements are required in small assembly spaces. From a mechanical point of view, the AMSABS 4B is based on the MONORAIL BM roller guide up to a length of 6m. The distance measurement system's compact housing facilitates the construction of highly compact axes. SCHNEEBERGER provides a fully digital interface with various cable lengths in order to connect it with the SSI, SSI+SinCos and FANUC control units. Various options regarding lubrication and sealing of the measuring carriages mean that optimal adjustments can be made to the requirements of the application. The easily exchangeable reading head is identical and replaceable for all sizes.

Features of System MONORAIL AMSABS 4B

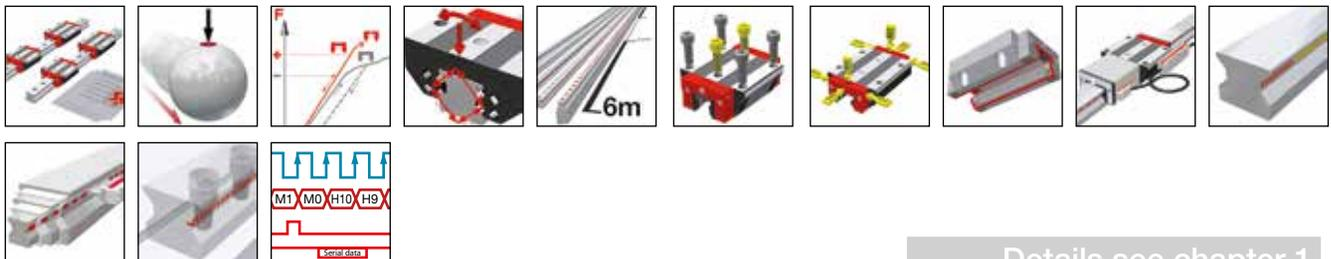

Details see chapter 1

10.1 Overview of types, sizes and available options



Product overview AMSABS 4B Rails	Page 174
Product overview AMSABS 4B Carriages	Page 175

10.2 Technical data and options

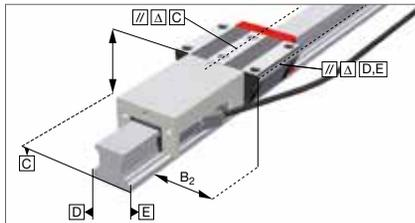

AMSABS 4B Size 15	Page 176
AMSABS 4B Size 20	Page 178
AMSABS 4B Size 25	Page 180
AMSABS 4B Size 30	Page 182
AMSABS 4B Size 35	Page 184
AMSABS 4B Size 45	Page 186

10.3 Accessories MONORAIL AMSABS 4B

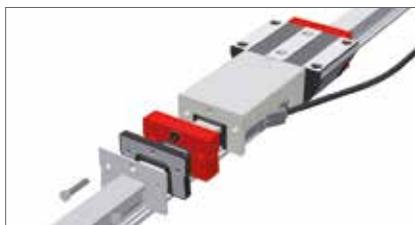

Accessories overview	Page 188
AMSABS 4B Rails accessory details	Page 79
AMSABS 4B Carriages accessory details	Page 81

10.4 Order key



Order key AMSABS 4B Rails	Page 189
Order key AMSABS 4B Carriages	Page 189

Product overview AMSABS 4B Rails

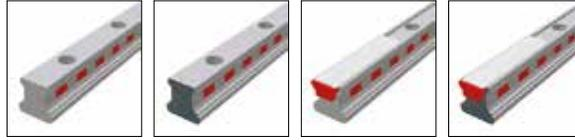

	N standard	ND standard, through hardened	C for cover strip	CD for cover strip, through hardened		
Buildsizes / Rail build forms						
Size 15		AMSABS 4B S 15-ND		AMSABS 4B S 15-CD		
Size 20	AMSABS 4B S 20-N		AMSABS 4B S 20-C			
Size 25	AMSABS 4B S 25-N		AMSABS 4B S 25-C			
Size 30	AMSABS 4B S 30-N		AMSABS 4B S 30-C			
Size 35	AMSABS 4B S 35-N		AMSABS 4B S 35-C			
Size 45	AMSABS 4B S 45-N		AMSABS 4B S 45-N			
Features						
Screwable from above	●	●	●	●		
Small assembly effort			●	●		
Great single-part system length	●		●			
For the support of metal covers		●				

Available options for AMSABS 4B Rails

Details see chapter 2

Accuracy

- G0 Highly accurate
- G1 Very accurate
- G2 Accurate
- G3 Standard

Straightness

- KC Standard

Coating

- CN None
- CH Hard chromium

Locating sides

- R11 Ref.bottom, scale bottom
- R12 Ref.bottom, scale top
- R21 Ref.top, scale bottom
- R22 Ref.top, scale top

Available accessories for AMSABS 4B Rails

Details see chapter 4.3

Plugs

Cover strips

Assembly tools

10.1 Overview of types, sizes and available options

AMSABS 4B Carriages

Product overview AMSABS 4B Carriages



	A standard,	B standard, long	C compact, high	D compact, high, long	F compact
Buildsizes / Carriage build forms					
Size 15	AMSABS 4B W 15-A		AMSABS 4B W 15-C		AMSABS 4B W 15-F
Size 20	AMSABS 4B W 20-A	AMSABS 4B W 20-B	AMSABS 4B W 20-C	AMSABS 4B W 20-D	
Size 25	AMSABS 4B W 25-A	AMSABS 4B W 25-B	AMSABS 4B W 25-C	AMSABS 4B W 25-D	
Size 30	AMSABS 4B W 30-A	AMSABS 4B W 30-B	AMSABS 4B W 30-C	AMSABS 4B W 30-D	
Size 35	AMSABS 4B W 35-A	AMSABS 4B W 35-B	AMSABS 4B W 35-C	AMSABS 4B W 35-D	
Size 45	AMSABS 4B W 45-A	AMSABS 4B W 45-B	AMSABS 4B W 45-C	AMSABS 4B W 45-D	
Features					
Screwable from above	●	●	●	●	●
Screwable from below	●	●			
For high loads and moments		●		●	
For medium loads and moments	●		●		●
For limited installation space					●

Available options for AMSABS 4B Carriages

Details see chapter 2

Accuracy

- G0 Highly accurate
- G1 Very accurate
- G2 Accurate
- G3 Standard

Preload

- V0 Very low
- V1 Low
- V2 Medium
- V3 High

Reference side

- R1 Ref. at bottom
- R2 Ref. on top

Coating

- CN None
- CH Hard chromium

Lube connections

- S10 Left center
- S20 Right center
- S11 Top left
- S21 Top right
- S12 Lower left side
- S22 Lower right side

- S13 Upper left side
- S23 Upper right side
- S32 Left side
- S42 Right side

Lubrication

- LN Oil protect
- LG Grease protect
- LV Full greasing

Interface

- TMH, absolute, 0.3m
- TRH, absolute, 3m

Reading head position

- P1 Right top
- P3 Left bottom

Available accessories for AMSABS 4B Carriages

Details see chapter 2.1 und 4.3

Additional wipers
Front plates

Bellows
Lube nipples

Assembly rails
Lube adapters

Lubrication plates
Cables

AMSABS 4B S 15 Drawings

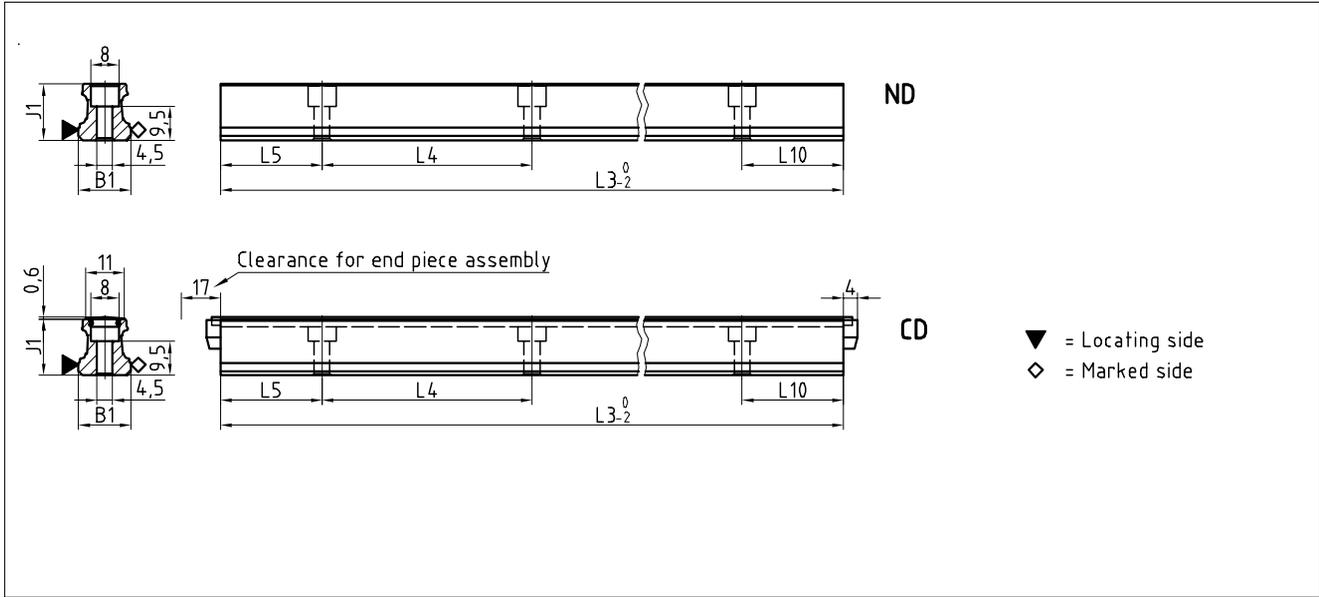

AMSABS 4B W 15 Drawings

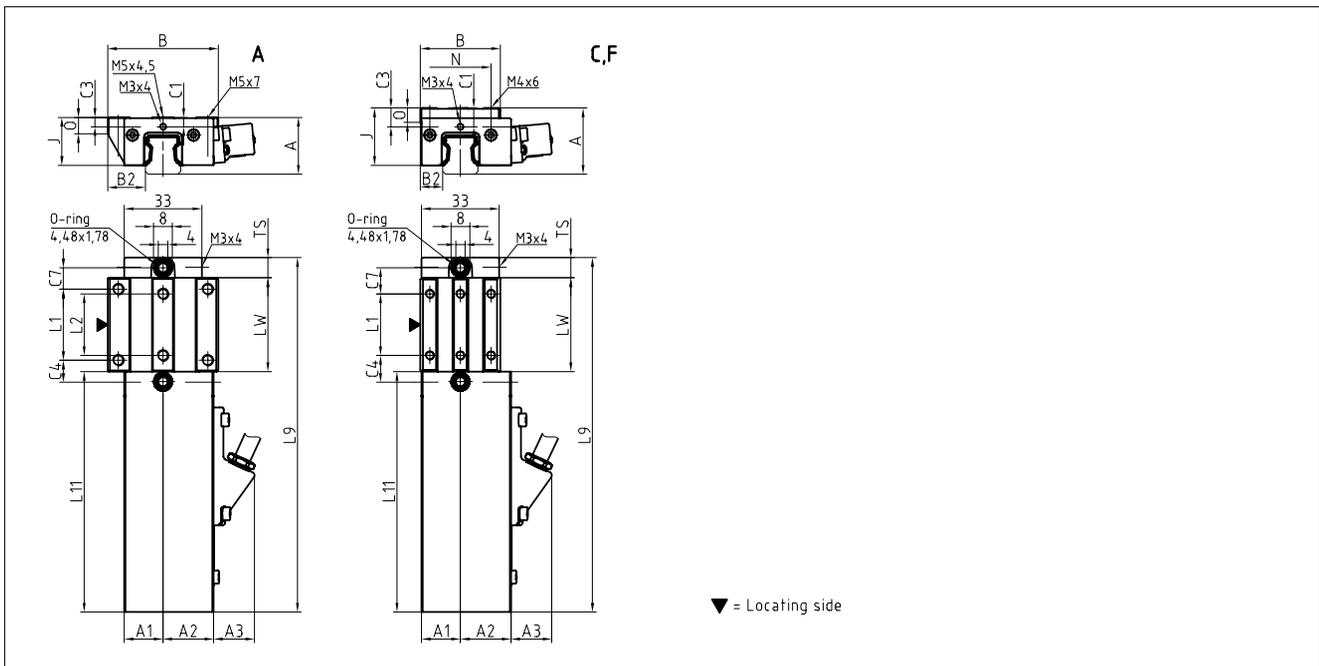

AMSABS 4B W 15 Rigidity diagram

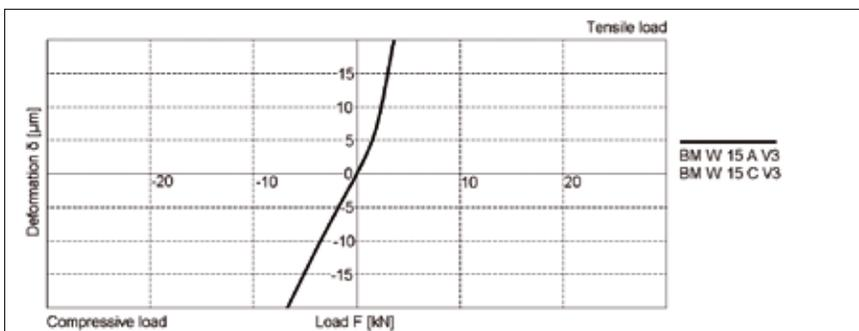

AMSABS 4B W 15 Load rating

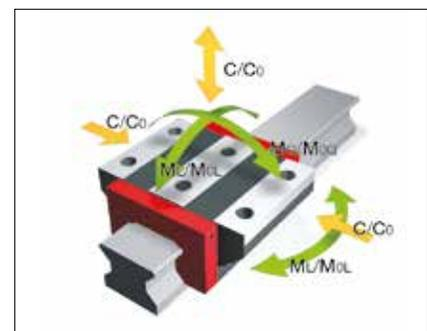

10.2 Technical data and options

AMSABS 4B Size 15

AMSABS 4B S 15 Dimensions

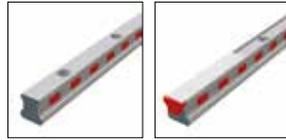

	AMSABS 4B S 15-ND	AMSABS 4B S 15-CD				
B1: Rail width	15	15				
J1: Rail height	15.7	15.7				
L3: Rail length max.	1500	1500				
L4: Spacing of fixing holes	60	60				
L5/L10: Position of first/last fixing hole	28.5	28.5				
Gew.: Rail weight, specific (kg/m)	1.4	1.3				

Available options for AMSABS 4B S 15



AMSABS 4B W 15 Dimensions and capacities



	AMSABS 4B W 15-A	AMSABS 4B W 15-C	AMSABS 4B W 15-F			
A: System height	24	28	24			
A1: Half width of housing on opposite side	16.5	16.5	16.5			
A2: Half width of housing on reading head side	21.5	21.5	21.5			
A3: Projection of reading head	17.5	17.5	17.5			
B: Carriage width	47	34	34			
B2: Distance between locating faces	16	9.5	9.5			
C1: Position of center front lube hole	4	8	4			
C3: Position of lateral lube hole	3.7	7.7	3.7			
C4: Position of lateral lube hole	9.3	11.3	11.3			
C7: Position of top lube hole	9.05	11.05	11.05			
J: Carriage height	20.2	24.2	20.2			
L1: Exterior fixing hole spacing	30	26	26			
L2: Interior fixing hole spacing	26	-	-			
L9: Carriage length with housing	149.6	149.6	149.6			
L11: Housing length	101.5	101.5	101.5			
Lw: Inner carriage body length	39.6	39.6	39.6			
N: Lateral fixing hole spacing	38	26	26			
O: Reference face height	7	6	5.5			
Ts: Front plate thickness	8.5	8.5	8.5			
Capacities and weights						
C0: Static load capacity (N)	19600	19600	19600			
C100: Dynamic load capacity (N)	9000	9000	9000			
MOQ: Static cross moment capacity (Nm)	181	181	181			
MOL: Static longitud. moment capacity (Nm)	146	146	146			
MQ: Dyn. cross moment capacity (Nm)	83	83	83			
ML: Dyn. longitud. moment capacity (Nm)	67	67	67			
Gew: Carriage weight (kg)	0.4	0.5	0.4			

Available options for AMSABS 4B W 15



AMSABS 4B S 20 Drawings

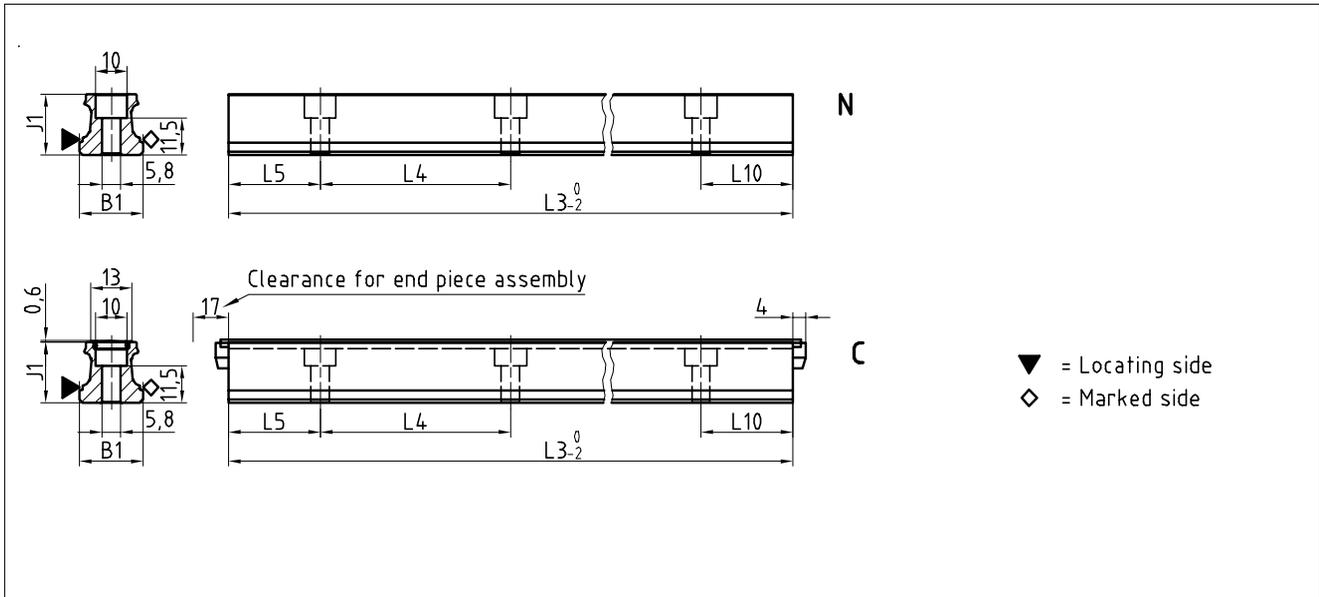

AMSABS 4B W 20 Drawings

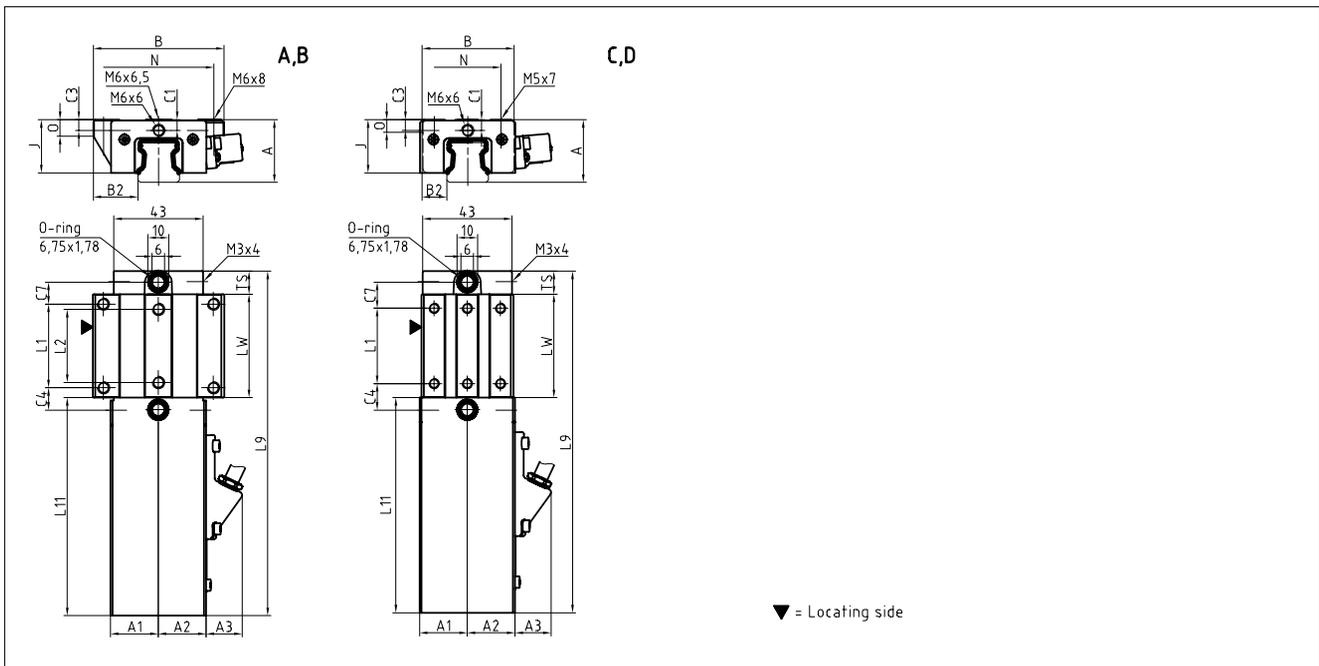

AMSABS 4B W 20 Rigidity diagram

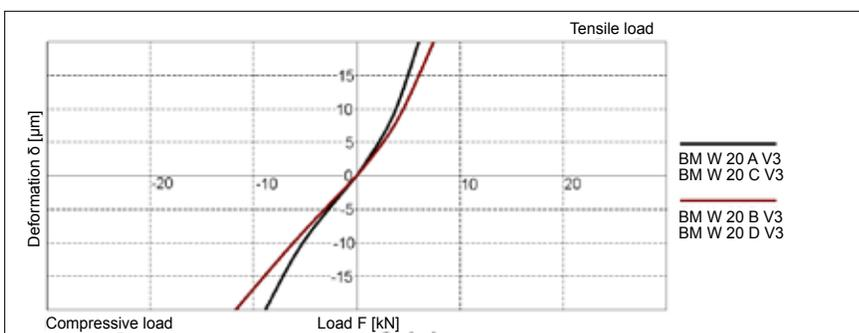

AMSABS 4B W 20 Load rating

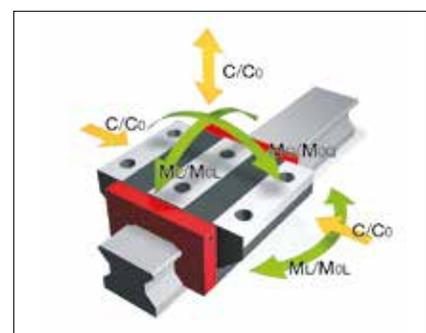

10.2 Technical data and options

AMSABS 4B Size 20

AMSABS 4B S 20 Dimensions

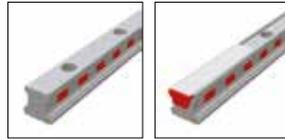

	AMSABS 4B S 20-N	AMSABS 4B S 20-C			
B1: Rail width	20	20			
J1: Rail height	19	19			
L3: Rail length max.	3000	3000			
L4: Spacing of fixing holes	60	60			
L5/L10: Position of first/last fixing hole	28.5	28.5			
Gew.: Rail weight, specific (kg/m)	2.2	2.1			

Available options for AMSABS 4B S 20



AMSABS 4B W 20 Dimensions and capacities

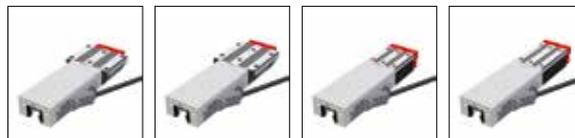

	AMSABS 4B W 20-A	AMSABS 4B W 20-B	AMSABS 4B W 20-C	AMSABS 4B W 20-D		
A: System height	30	30	30	30		
A1: Half width of housing on opposite side	23	23	23	23		
A2: Half width of housing on reading head side	23	23	23	23		
A3: Projection of reading head	17.5	17.5	17.5	17.5		
B: Carriage width	63	63	44	44		
B2: Distance between locating faces	21.5	21.5	12	12		
C1: Position of center front lube hole	5.2	5.2	5.2	5.2		
C3: Position of lateral lube hole	4.6	4.6	4.6	4.6		
C4: Position of lateral lube hole	10.75	18.75	12.75	13.75		
C7: Position of top lube hole	10.25	18.25	12.25	13.25		
J: Carriage height	25.5	25.5	25.5	25.5		
L1: Exterior fixing hole spacing	40	40	36	50		
L2: Interior fixing hole spacing	35	35	-	-		
L9: Carriage length with housing	164.5	180.5	164.5	180.5		
L11: Housing length	104	104	104	104		
Lw: Inner carriage body length	49.5	65.5	49.5	65.5		
N: Lateral fixing hole spacing	53	53	32	32		
O: Reference face height	8	8	6	6		
Ts: Front plate thickness	11	11	11	11		
Capacities and weights						
C0: Static load capacity (N)	31400	41100	31400	41100		
C100: Dynamic load capacity (N)	14400	17400	14400	17400		
MOQ: Static cross moment capacity (Nm)	373	490	373	490		
MOL: Static longitud. moment capacity (Nm)	292	495	292	495		
MQ: Dyn. cross moment capacity (Nm)	171	206	171	206		
ML: Dyn. longitud. moment capacity (Nm)	134	208	134	208		
Gew.: Carriage weight (kg)	0.7	0.8	0.6	0.7		

Available options for AMSABS 4B W 20



AMSABS 4B S 25 Drawings

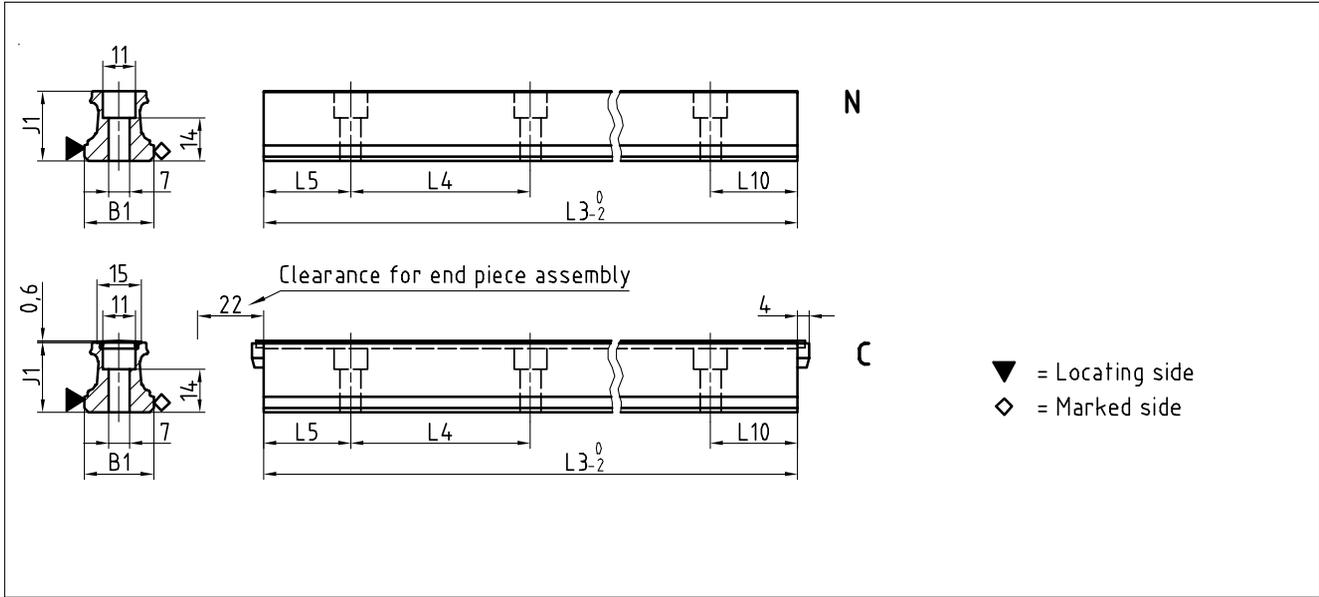

AMSABS 4B W 25 Drawings

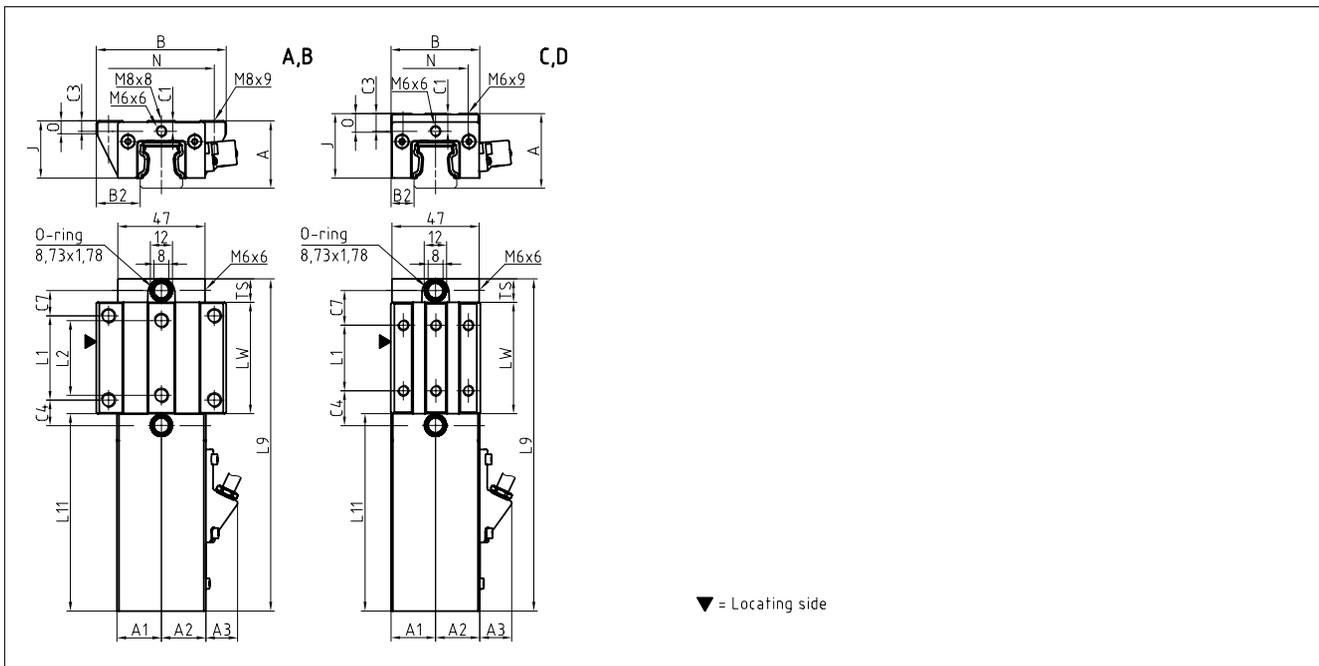

AMSABS 4B W 25 Rigidity diagram

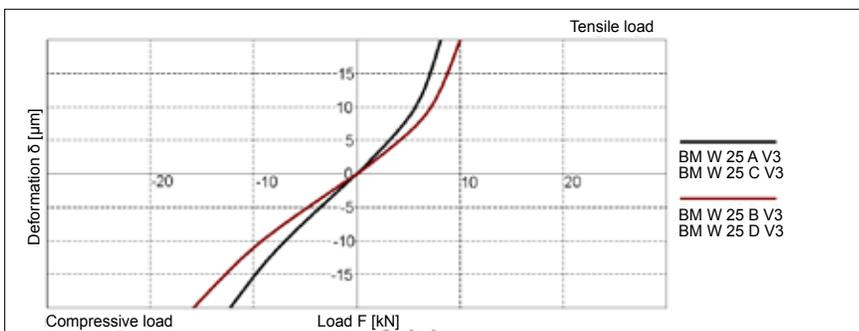

AMSABS 4B W 25 Load rating

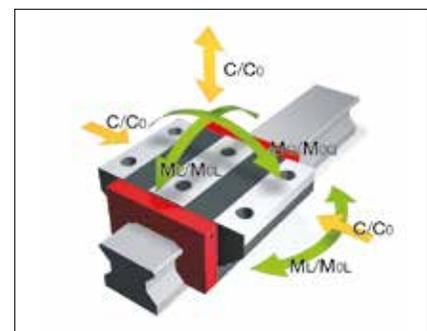

10.2 Technical data and options

AMSABS 4B Size 25

AMSABS 4B S 25 Dimensions

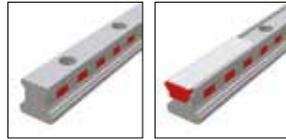

	AMSABS 4B S 25-N	AMSABS 4B S 25-C				
B1: Rail width	23	23				
J1: Rail height	22.7	22.7				
L3: Rail length max.	6000	6000				
L4: Spacing of fixing holes	60	60				
L5/L10: Position of first/last fixing hole	28.5	28.5				
Gew.: Rail weight, specific (kg/m)	3.0	2.8				

Available options for AMSABS 4B S 25



AMSABS 4B W 25 Dimensions and capacities



	AMSABS 4B W 25-A	AMSABS 4B W 25-B	AMSABS 4B W 25-C	AMSABS 4B W 25-D			
A: System height	36	36	40	40			
A1: Half width of housing on opposite side	23.9	23.9	23.9	23.9			
A2: Half width of housing on reading head side	23.9	23.9	23.9	23.9			
A3: Projection of reading head	17.4	17.4	17.4	17.4			
B: Carriage width	70	70	48	48			
B2: Distance between locating faces	23.5	23.5	12.5	12.5			
C1: Position of center front lube hole	5.5	5.5	9.5	9.5			
C3: Position of lateral lube hole	5.5	5.5	9.5	9.5			
C4: Position of lateral lube hole	13.75	23.25	18.75	20.75			
C7: Position of top lube hole	13.5	23	18.5	20.5			
J: Carriage height	30.5	30.5	34.5	34.5			
L1: Exterior fixing hole spacing	45	45	35	50			
L2: Interior fixing hole spacing	40	40	-	-			
L9: Carriage length with housing	177.5	196.5	177.5	196.5			
L11: Housing length	105.5	105.5	105.5	105.5			
Lw: Inner carriage body length	59.5	78.5	59.5	78.5			
N: Lateral fixing hole spacing	57	57	35	35			
O: Reference face height	7	7	11	11			
Ts: Front plate thickness	12.5	12.5	12.5	12.5			
Capacities and weights							
C0: Static load capacity (N)	46100	60300	46100	60300			
C100: Dynamic load capacity (N)	21100	25500	21100	25500			
MOQ: Static cross moment capacity (Nm)	631	825	631	825			
MOL: Static longitud. moment capacity (Nm)	513	863	513	863			
MQ: Dyn. cross moment capacity (Nm)	289	349	289	349			
ML: Dyn. longitud. moment capacity (Nm)	235	365	235	365			
Gew.: Carriage weight (kg)	1.0	1.2	0.9	1.1			

Available options for AMSABS 4B W 25



AMSABS 4B S 30 Drawings

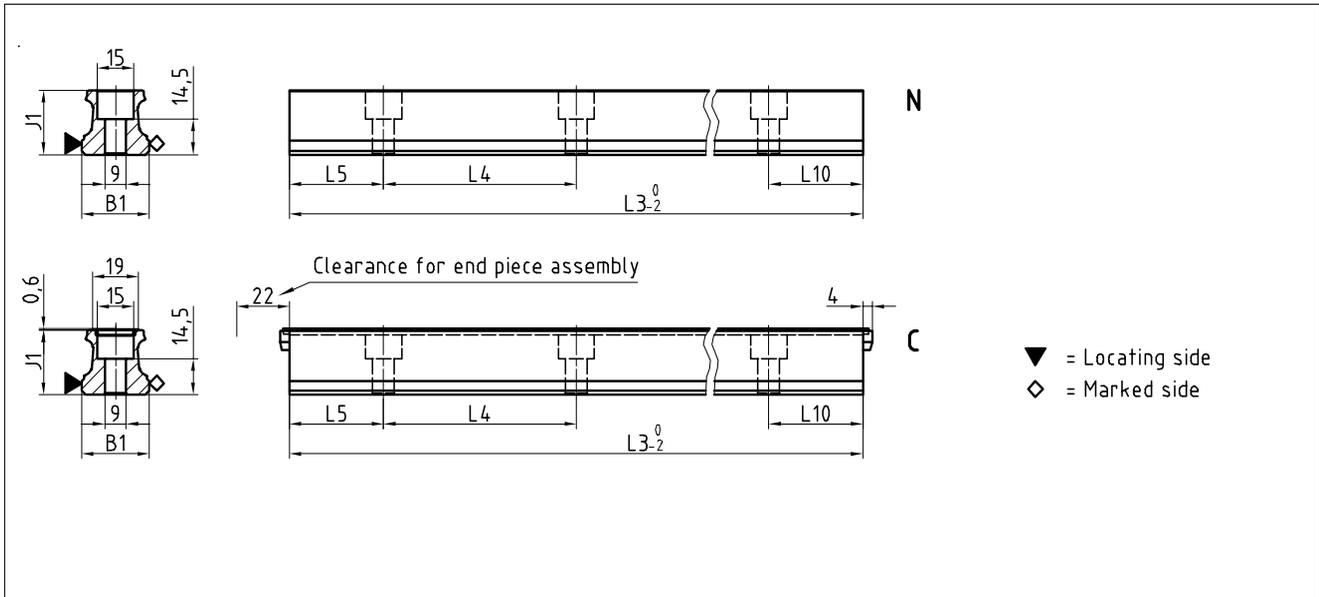

AMSABS 4B W 30 Drawings

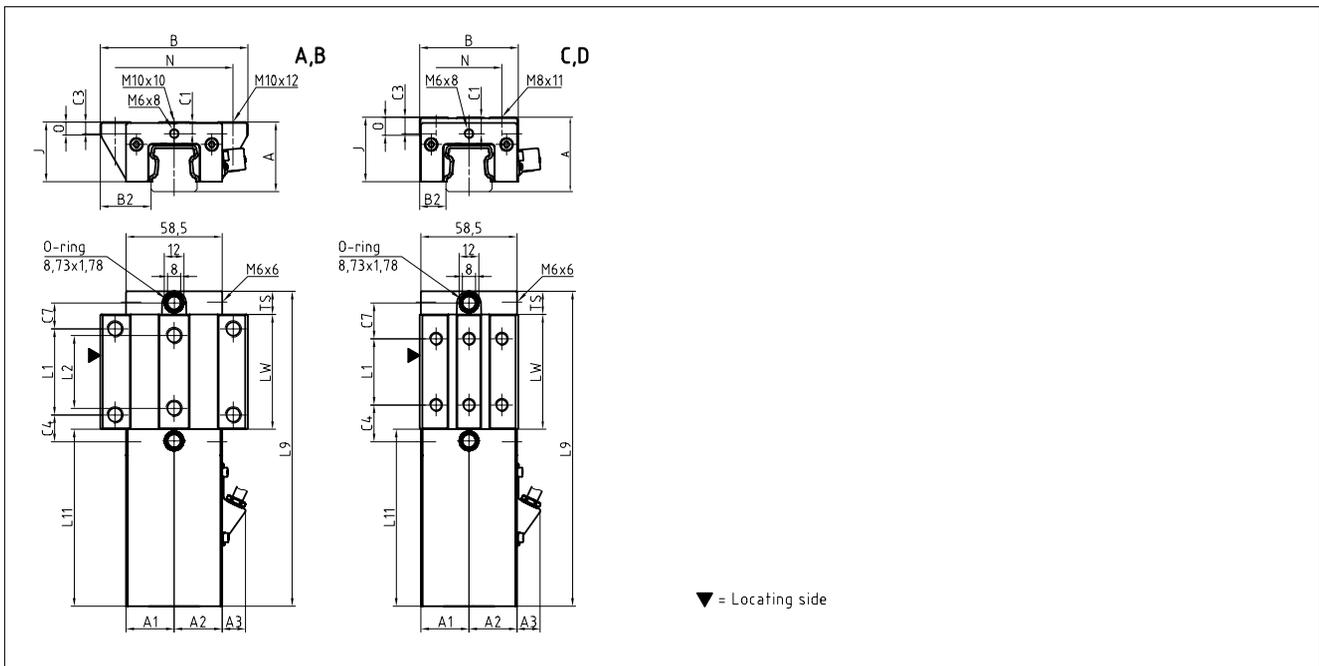

AMSABS 4B W 30 Rigidity diagram

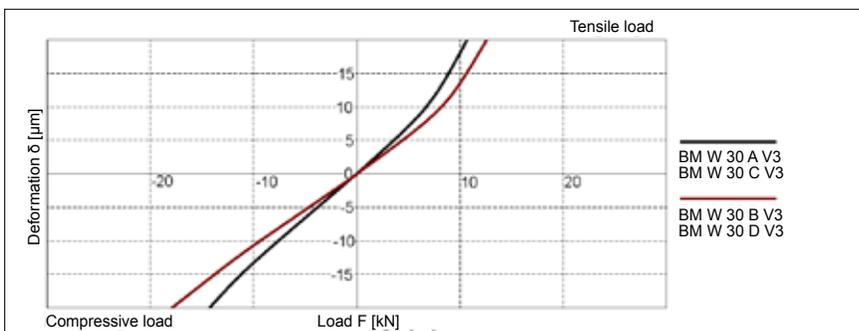

AMSABS 4B W 30 Load rating

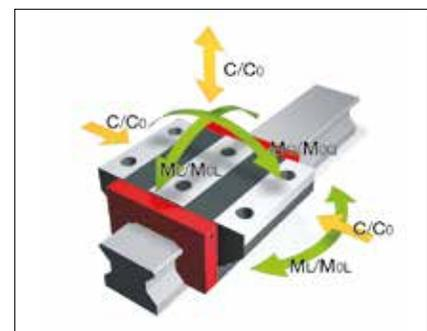

10.2 Technical data and options

AMSABS 4B Size 30

AMSABS 4B S 30 Dimensions



	AMSABS 4B S 30-N	AMSABS 4B S 30-C			
B1: Rail width	28	28			
J1: Rail height	26	26			
L3: Rail length max.	6000	6000			
L4: Spacing of fixing holes	80	80			
L5/L10: Position of first/last fixing hole	38.5	38.5			
Gew.: Rail weight, specific (kg/m)	4.3	4.1			

Available options for AMSABS 4B S 30



AMSABS 4B W 30 Dimensions and capacities

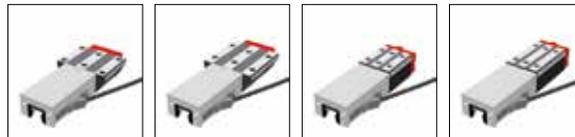

	AMSABS 4B W 30-A	AMSABS 4B W 30-B	AMSABS 4B W 30-C	AMSABS 4B W 30-D		
A: System height	42	42	45	45		
A1: Half width of housing on opposite side	29.3	29.3	29.3	29.3		
A2: Half width of housing on reading head side	29.3	29.3	29.3	29.3		
A3: Projection of reading head	14.4	14.4	14.4	14.4		
B: Carriage width	90	90	60	60		
B2: Distance between locating faces	31	31	16	16		
C1: Position of center front lube hole	7	7	10	10		
C3: Position of lateral lube hole	6	6	9	9		
C4: Position of lateral lube hole	16.2	27.2	22.2	23.2		
C7: Position of top lube hole	15.7	26.7	21.7	22.7		
J: Carriage height	35.9	35.9	38.9	38.9		
L1: Exterior fixing hole spacing	52	52	40	60		
L2: Interior fixing hole spacing	44	44	-	-		
L9: Carriage length with housing	190.4	212.4	190.4	212.4		
L11: Housing length	107	107	107	107		
Lw: Inner carriage body length	69.4	91.4	69.4	91.4		
N: Lateral fixing hole spacing	72	72	40	40		
O: Reference face height	7.8	7.8	11	11		
Ts: Front plate thickness	14	14	14	14		
Capacities and weights						
C0: Static load capacity (N)	63700	83300	63700	83300		
C100: Dynamic load capacity (N)	29200	35300	29200	35300		
MOQ: Static cross moment capacity (Nm)	1084	1414	1084	1414		
MOL: Static longitud. moment capacity (Nm)	829	1390	829	1390		
MQ: Dyn. cross moment capacity (Nm)	497	599	497	599		
ML: Dyn. longitud. moment capacity (Nm)	380	589	380	589		
Gew: Carriage weight (kg)	1.6	1.9	1.4	1.7		

Available options for AMSABS 4B W 30



AMSABS 4B S 35 Drawings

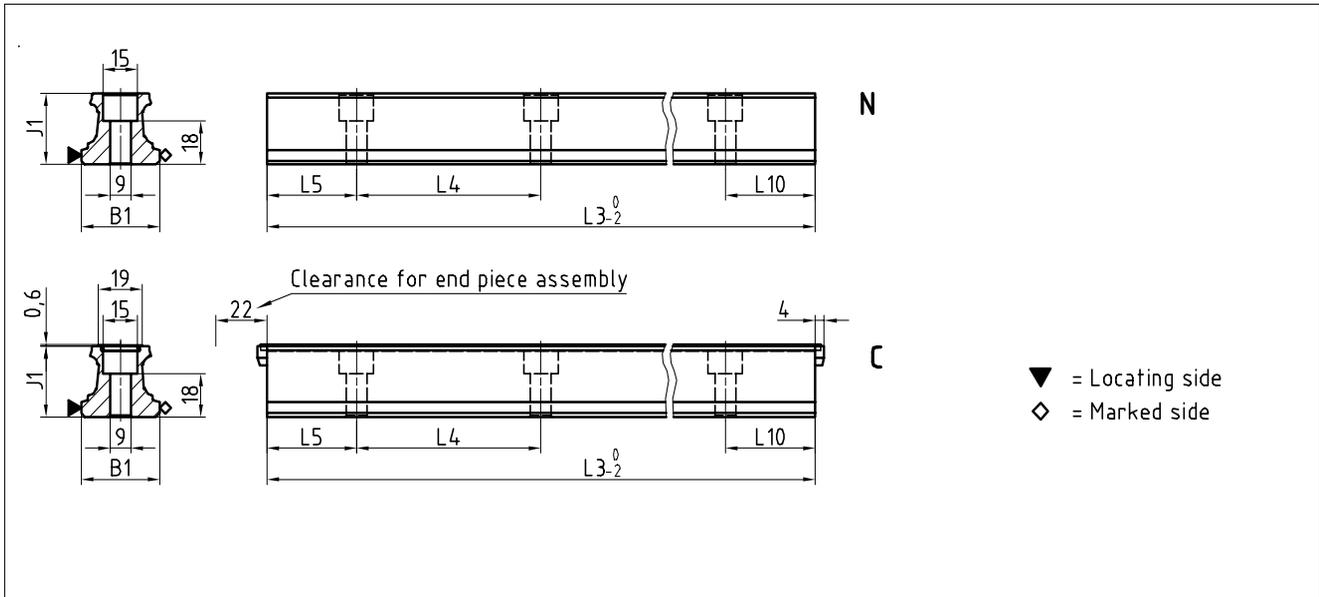

AMSABS 4B W 35 Drawings

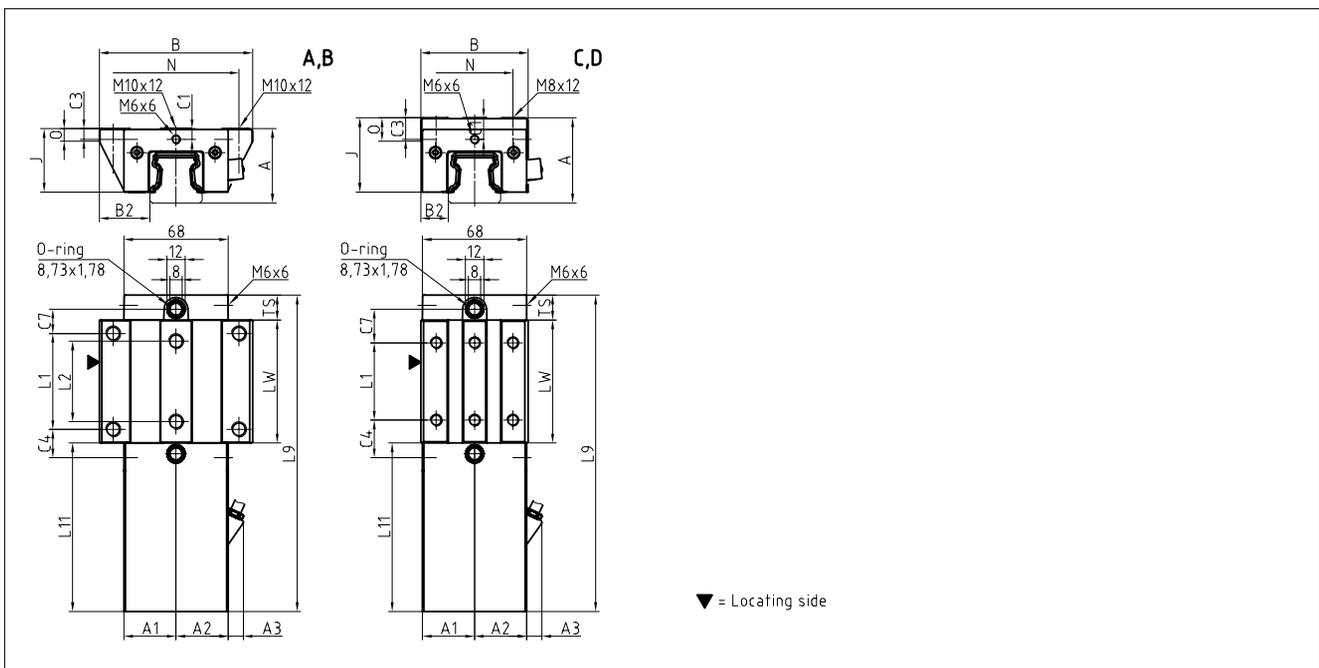

AMSABS 4B W 35 Rigidity diagram

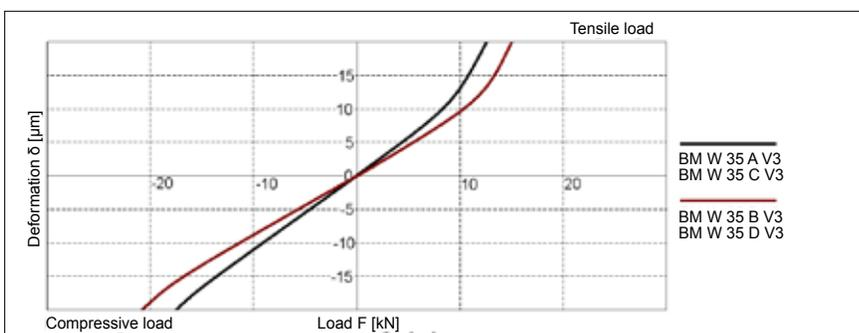

AMSABS 4B W 35 Load rating

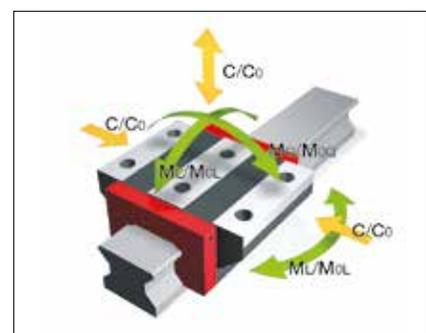

10.2 Technical data and options

AMSABS 4B Size 35

AMSABS 4B S 35 Dimensions

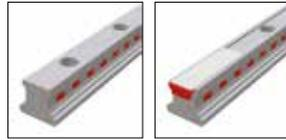

	AMSABS 4B S 35-N	AMSABS 4B S 35-C				
B1: Rail width	34	34				
J1: Rail height	29.5	29.5				
L3: Rail length max.	6000	6000				
L4: Spacing of fixing holes	80	80				
L5/L10: Position of first/last fixing hole	38.5	38.5				
Gew.: Rail weight, specific (kg/m)	5.4	5.2				

Available options for AMSABS 4B S 35

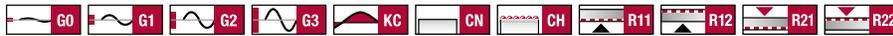

AMSABS 4B W 35 Dimensions and capacities

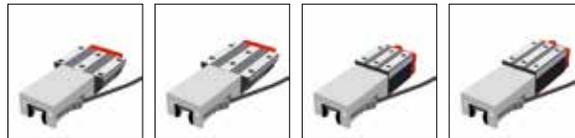

	AMSABS 4B W 35-A	AMSABS 4B W 35-B	AMSABS 4B W 35-C	AMSABS 4B W 35-D			
A: System height	48	48	55	55			
A1: Half width of housing on opposite side	34	34	34	34			
A2: Half width of housing on reading head side	34	34	34	34			
A3: Projection of reading head	10.1	10.1	10.1	10.1			
B: Carriage width	100	100	70	70			
B2: Distance between locating faces	33	33	18	18			
C1: Position of center front lube hole	7	7	14	14			
C3: Position of lateral lube hole	6.5	6.5	13.5	13.5			
C4: Position of lateral lube hole	18.3	31.05	24.3	26.05			
C7: Position of top lube hole	15.8	28.55	21.8	23.55			
J: Carriage height	41	41	48	48			
L1: Exterior fixing hole spacing	62	62	50	72			
L2: Interior fixing hole spacing	52	52	-	-			
L9: Carriage length with housing	204.6	230.1	204.6	230.1			
L11: Housing length	109	109	109	109			
Lw: Inner carriage body length	79.6	105.1	79.6	105.1			
N: Lateral fixing hole spacing	82	82	50	50			
O: Reference face height	8	8	15	15			
Ts: Front plate thickness	16	16	16	16			

Capacities and weights

C0: Static load capacity (N)	84400	110300	84400	110300			
C100: Dynamic load capacity (N)	38700	46700	38700	46700			
MOQ: Static cross moment capacity (Nm)	1566	2048	1566	2048			
MOL: Static longitud. moment capacity (Nm)	1252	2104	1252	2104			
MQ: Dyn. cross moment capacity (Nm)	718	867	718	867			
ML: Dyn. longitud. moment capacity (Nm)	574	891	574	891			
Gew.: Carriage weight (kg)	2.3	2.8	2.2	2.7			

Available options for AMSABS 4B W 35



AMSABS 4B S 45 Drawings

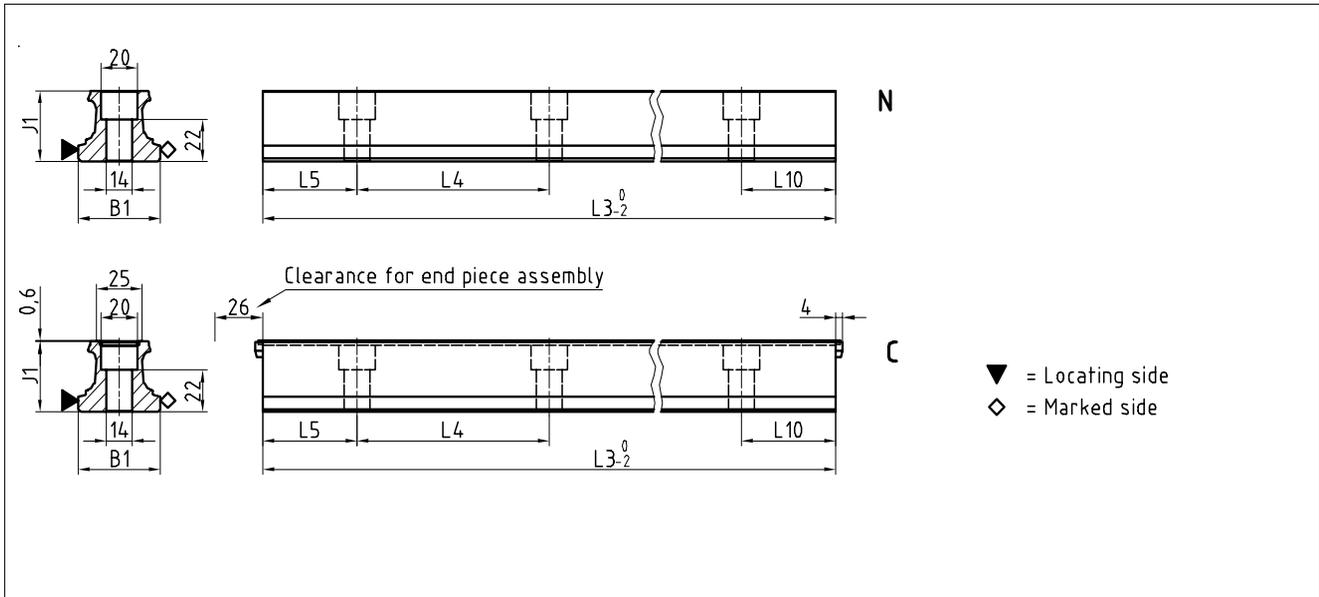

AMSABS 4B W 45 Drawings

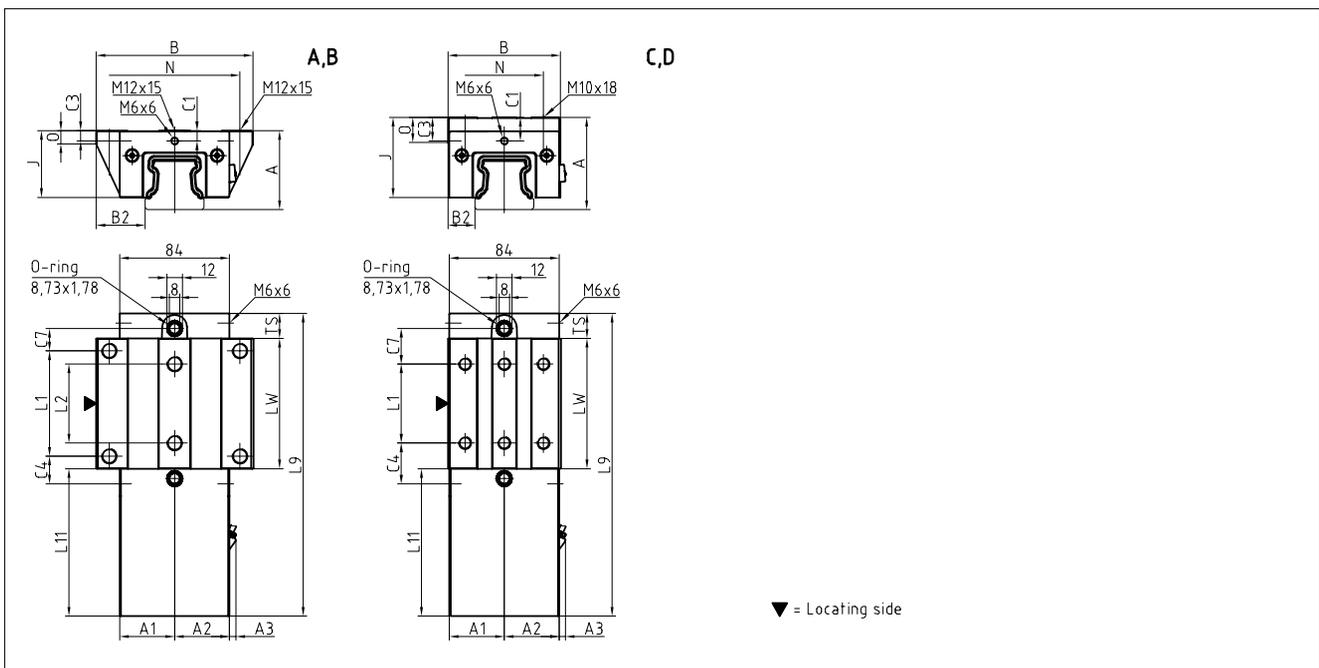

AMSABS 4B W 45 Rigidity diagram

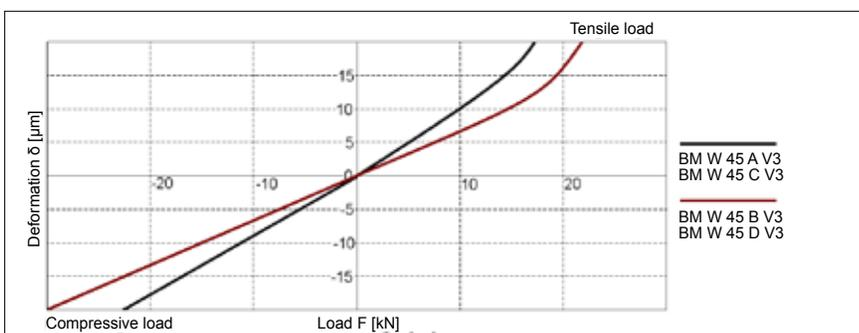

AMSABS 4B W 45 Load rating

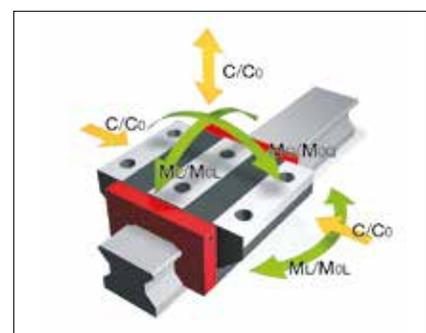

10.2 Technical data and options

AMSABS 4B Size 45

AMSABS 4B S 45 Dimensions



	AMSABS 4B S 45-N	AMSABS 4B S 45-C				
B1: Rail width	45	45				
J1: Rail height	37	37				
L3: Rail length max.	6 000	6 000				
L4: Spacing of fixing holes	105	105				
L5/L10: Position of first/last fixing hole	51	51				
Gew.: Rail weight, specific (kg/m)	8.8	8.6				

Available options for AMSABS 4B S 45



AMSABS 4B W 45 Dimensions and capacities

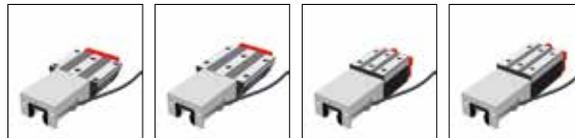

	AMSABS 4B W 45-A	AMSABS 4B W 45-B	AMSABS 4B W 45-C	AMSABS 4B W 45-D			
A: System height	60	60	70	70			
A1: Half width of housing on opposite side	42	42	42	42			
A2: Half width of housing on reading head side	42	42	42	42			
A3: Projection of reading head	5	5	5	5			
B: Carriage width	120	120	86	86			
B2: Distance between locating faces	37.5	37.5	20.5	20.5			
C1: Position of center front lube hole	8	8	18	18			
C3: Position of lateral lube hole	8	8	18	18			
C4: Position of lateral lube hole	21.05	36.8	31.05	36.8			
C7: Position of top lube hole	17.05	32.8	27.05	32.8			
J: Carriage height	50.8	50.8	60.8	60.8			
L1: Exterior fixing hole spacing	80	80	60	80			
L2: Interior fixing hole spacing	60	60	-	-			
L9: Carriage length with housing	230.1	261.6	230.1	261.6			
L11: Housing length	112	112	112	112			
Lw: Inner carriage body length	99.1	130.6	99.1	130.6			
N: Lateral fixing hole spacing	100	100	60	60			
O: Reference face height	10	10	19	19			
Ts: Front plate thickness	19	19	19	19			
Capacities and weights							
C0: Static load capacity (N)	134800	176300	134800	176300			
C100: Dynamic load capacity (N)	61900	74700	61900	74700			
MOQ: Static cross moment capacity (Nm)	3193	4175	3193	4175			
MOL: Static longitud. moment capacity (Nm)	2498	4199	2498	4199			
MQ: Dyn. cross moment capacity (Nm)	1466	1769	1466	1769			
ML: Dyn. longitud. moment capacity (Nm)	1147	1779	1147	1779			
Gew.: Carriage weight (kg)	4.0	4.9	4.0	5.0			

Available options for AMSABS 4B W 45



AMSABS 4B Rails accessories overview

Accessories	AMSABS 4B S 15	AMSABS 4B S 20	AMSABS 4B S 25	AMSABS 4B S 30	AMSABS 4B S 35	AMSABS 4B S 45	
Plugs:							
Plastic plugs	BRK 15	BRK 20	BRK 25	BRK 30	BRK 35	BRK 45	
Cover strips:							
Cover strip (spare part)	BAC 15	BAC 20	BAC 25	BAC 30	BAC 35	BAC 45	
End piece for cover strip (spare part)	EST 15-BAC	EST 20-BAC	EST 25-BAC	EST 30-BAC	EST 35-BAC	EST 45-BAC	
Securing band for cover strip (spare part)	BSC 15-BAC	BSC 20-BAC	BSC 25-BAC	BSC 30-BAC	BSC 35-BAC	BSC 45-BAC	
Assembly tools:							
Installation tool for cover strip	BWC 15	BWC 20	BWC 25	BWC 30	BWC 35	BWC 45	

AMSABS 4B Carriages accessories overview

Accessories	AMSABS 4B W 15	AMSABS 4B W 20	AMSABS 4B W 25	AMSABS 4B W 30	AMSABS 4B W 35	AMSABS 4B W 45	
Additional wipers:							
Additional wipers NBR	ZBN 15	ZBN 20	ZBN 25	ZBN 30	ZBN 35	ZBN 45	
Additional wipers Viton	ZBV 15	ZBV 20	ZBV 25	ZBV 30	ZBV 35	ZBV 45	
Metal wiper	ABM 15-A	ABM 20-A	ABM 25-A	ABM 30-A	ABM 35-A	ABM 45-A	
Bellows:							
Bellows	-	FBB 20	FBB 25	FBB 30	FBB 35	FBB 45	
Adapter plate for bellows (spare part)	-	ZPB 20	ZPB 25	ZPB 30	ZPB 35	ZPB 45	
End plate for bellows (spare part)	-	EPB 20	EPB 25	EPB 30	EPB 35	EPB 45	
Assembly rails:							
Assembly rail	MBM 15	MBM 20	MBM 25	MBM 30	MBM 35	MBM 45	
Lubrication plates:							
Lubrication plate	SPL 15-BM	SPL 20-BM	SPL 25-BM	SPL 30-BM	SPL 35-BM	SPL 45-BM	
Front plates:							
Cross wiper for front plate (spare part)	QAS 15-STB	QAS 20-STB	QAS 25-STB	QAS 30-STB	QAS 35-STB	QAS 45-STB	
Lube nipples:							
Hydraulic-type grease nipple straight	-	SN 6	SN 6	SN 6	SN 6	SN 6	
Hydraulic-type grease nipple 45°	-	SN 6-45	SN 6-45	SN 6-45	SN 6-45	SN 6-45	
Hydraulic-type grease nipple 90°	-	SN 6-90	SN 6-90	SN 6-90	SN 6-90	SN 6-90	
Flush type grease nipple M3	SN 3-T	SN 3-T	-	-	-	-	
Flush type grease nipple M6	-	SN 6-T	SN 6-T	SN 6-T	SN 6-T	SN 6-T	
Grease gun for SN 3-T und SN 6-T	SFP-T3	SFP-T3	SFP-T3	SFP-T3	SFP-T3	SFP-T3	
Lube adapters:							
Straight screw-in connection M3	SA 3-D3	SA 3-D3	-	-	-	-	
Lubrication adapter M8 round-head	-	SA 6-RD-M8	SA 6-RD-M8	SA 6-RD-M8	SA 6-RD-M8	SA 6-RD-M8	
Lubrication adapter M8 hexagon head	-	-	-	SA 6-6KT-M8	SA 6-6KT-M8	SA 6-6KT-M8	
Lubrication adapter G1/8 hexagon head	-	-	-	SA 6-6KT-G1/8	SA 6-6KT-G1/8	SA 6-6KT-G1/8	
Swivel screw connection for pipe d=4 mm	-	SV 6-D4	SV 6-D4	SV 6-D4	SV 6-D4	SV 6-D4	
Swivel screw connection M6	-	SV 6-M6	SV 6-M6	SV 6-M6	SV 6-M6	SV 6-M6	
Swivel screw connection M6 long	-	SV 6-M6-L	SV 6-M6-L	SV 6-M6-L	SV 6-M6-L	SV 6-M6-L	
Swivel screw connection M8	-	SV 6-M8	SV 6-M8	SV 6-M8	SV 6-M8	SV 6-M8	
Swivel screw connection M8 long	-	SV 6-M8-L	SV 6-M8-L	SV 6-M8-L	SV 6-M8-L	SV 6-M8-L	

10.4 Order key

Individual guide rails and carriages are ordered in accordance with the order codes described below.

AMSABS 4B carriages consist of guide carriage, casing and reading head.

All MONORAIL BM carriages can also be used with AMSABS 4B rails.

Q.v. chapter 2 and chapter 4.3 for the order key for accessories.

Separate order codes are used in each case for rails, carriages and accessories. This also applies to different versions of rails and carriages.

All guide components are supplied individually as standard, i.e. unassembled.

If required, SCHNEEBERGER can also supply rails and carriages assembled incl. accessories as complete systems. Please note the ordering instructions in chapter 2.4 if this applies.

Order code for AMSABS 4B Rails

	1x	AMSABS 4B S	25	-N	-G2	-KC	-R12	-958	-28	-28	-CN	-TA1
Quantity												
Rail												
Size												
Type												
Accuracy												
Straightness												
Reference side												
Rail length L3												
Position of first fixing hole L5												
Position of last fixing hole L10												
Coating												
Type of magnetisation												

NB

Q.v. chapter 10.1 to 10.3 for an overview of types, details of shapes, available options and accessories.

Q.v. chapter 2 for a description of the options.

If possible, standard lengths are preferred for L3 rail length.

These are calculated with the table values in chapter 10.2 using the following formula: $L3 = n \times L4 + L5 + L10 \leq L3max$.

Order code for AMSABS 4B Carriages

	1x	AMSABS 4B W	25	-A	-P1	-G2	-V1	-R1	-CN	-S10	-LN	-TMH
Quantity												
Carriage												
Size												
Type												
Reading head position												
Accuracy												
Preload												
Reference side												
Coating												
Lube connection												
Lubrication as delivered condition												
Interface												

NB

Q.v. chapter 10.1 to 10.3 for an overview of types, details of shapes, available options and accessories.

Q.v. chapter 2 for a description of the options.

For detailed information about current configuration options for the interfaces, please visit our website at www.schneeberger.com

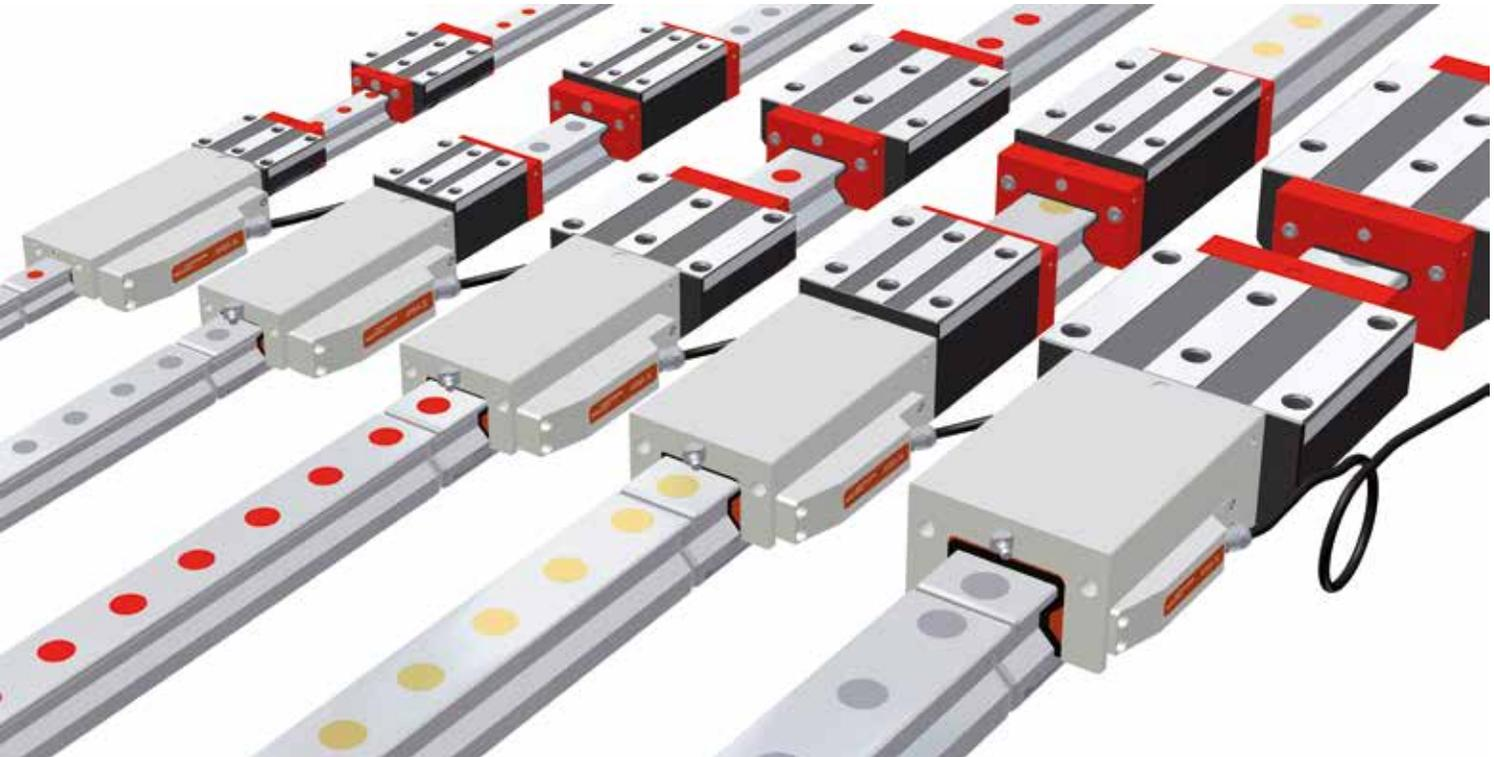

With the MONORAIL AMSA 3L, SCHNEEBERGER provides an integrated measuring system for distance measurement for the construction of particularly long axes with specific requirements regarding the accuracy of the system. From a mechanical point of view, the AMSA 3L is based on the SCHNEEBERGER MONORAIL MR roller guide. The special design of the rail joints combined with the AMSA 3L reading head means that the joints can be traversed and any long measuring axes can be constructed. The analogue interface 1Vpp (200µm signal period) with various cable lengths is available as a control interface. Various options regarding lubrication and sealing of the measuring carriages mean that optimal adjustments can be made to the requirements of the application. The easily exchangeable reading head is identical and replaceable for all sizes.

Features of System MONORAIL AMSA 3L

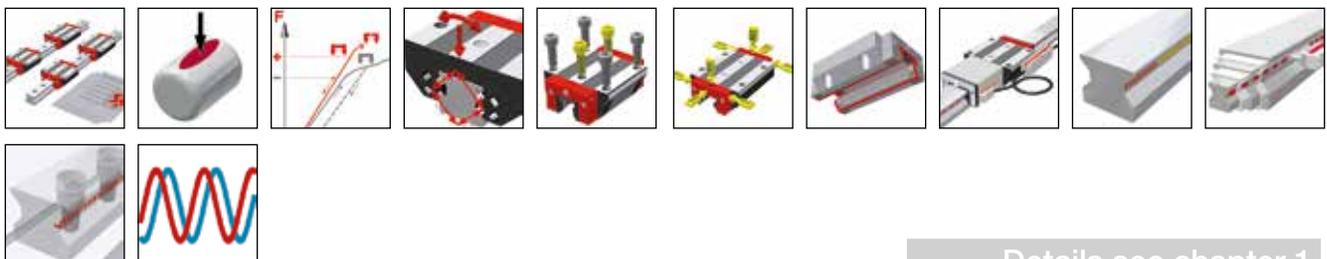

Details see chapter 1

11.1 Overview of types, sizes and available options



Product overview AMSA 3L Rails	Page 194
Product overview AMSA 3L Carriages	Page 195

11.2 Technical data and options

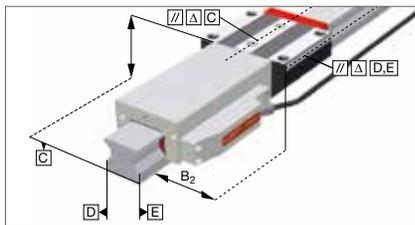

AMSA 3L Size 25	Page 196
AMSA 3L Size 35	Page 198
AMSA 3L Size 45	Page 200
AMSA 3L Size 55	Page 202
AMSA 3L Size 65	Page 204

11.3 Accessories MONORAIL AMSA 3L



Accessories overview	Page 206
AMSA 3L Rails accessory details	Page 207
AMSA 3L Carriages accessory details	Page 56

11.4 Order key



Order key AMSA 3L Rails	Page 208
Order key AMSA 3L Carriages	Page 208

Product overview AMSA 3L Rails



N
standard

Buildsizes / Rail build forms

Size 25	AMSA 3L S 25-N			
Size 35	AMSA 3L S 35-N			
Size 45	AMSA 3L S 45-N			
Size 55	AMSA 3L S 55-N			
Size 65	AMSA 3L S 65-N			

Features

Screwable from above	•			
Large system lengths	•			

Available options for AMSA 3L Rails

Details see chapter 2

Accuracy

G1 Very accurate

Straightness

KC Standard

Coating

CN None

CH Hard chromium

Locating sides

R11 Ref.bottom, scale bottom

R22 Ref.top, scale top

Available accessories for AMSA 3L Rails

Details see chapter 3.3

Plugs

Assembly tools

11.1 Overview of types, sizes and available options

AMSA 3L Carriages

Product overview AMSA 3L Carriages

	 A standard,	 B standard, long	 C compact, high	 D compact, high, long		
Buildsizes / Carriage build forms						
Size 25	AMSA 3L W 25-A	AMSA 3L W 25-B	AMSA 3L W 25-C	AMSA 3L W 25-D		
Size 35	AMSA 3L W 35-A	AMSA 3L W 35-B	AMSA 3L W 35-C	AMSA 3L W 35-D		
Size 45	AMSA 3L W 45-A	AMSA 3L W 45-B	AMSA 3L W 45-C	AMSA 3L W 45-D		
Size 55	AMSA 3L W 55-A	AMSA 3L W 55-B	AMSA 3L W 55-C	AMSA 3L W 55-D		
Size 65	AMSA 3L W 65-A	AMSA 3L W 65-B	AMSA 3L W 65-C	AMSA 3L W 65-D		
Features						
Screwable from above	●	●	●	●		
Screwable from below	●	●				
For high loads and moments		●		●		
For medium loads and moments	●		●			

Available options for AMSA 3L Carriages

Details see chapter 2

Accuracy

-  G0 Highly accurate
-  G1 Very accurate
-  G2 Accurate
-  G3 Standard

Preload

-  V1 Low
-  V2 Medium
-  V3 High

Reference side

-  R1 Ref. at bottom
-  R2 Ref. on top

Coating

-  CN None
-  CH Hard chromium

Lube connections

-  S10 Left center
-  S20 Right center
-  S11 Top left
-  S21 Top right
-  S12 Lower left side
-  S22 Lower right side

-  S13 Upper left side
-  S23 Upper right side
-  S32 Left side
-  S42 Right side

Lubrication

-  LN Oil protect
-  LG Grease protect
-  LV Full greasing

Interface

-  TMU TMU, analog, 0.3m
-  TSH TSU, analog, 3m

Reading head position

-  P1 Right top
-  P3 Left bottom

Available accessories for AMSA 3L Carriages

Details see chapter 2.1 and 3.3

Additional wipers
Lube nipples

Assembly rails
Lube adapters

Lubrication plates

Front plates

AMSA 3L S 25 Drawings

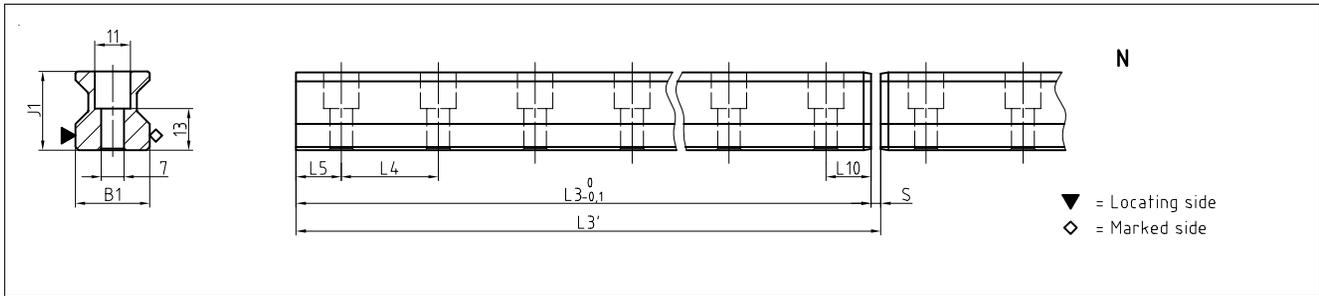

AMSA 3L W 25 Drawings

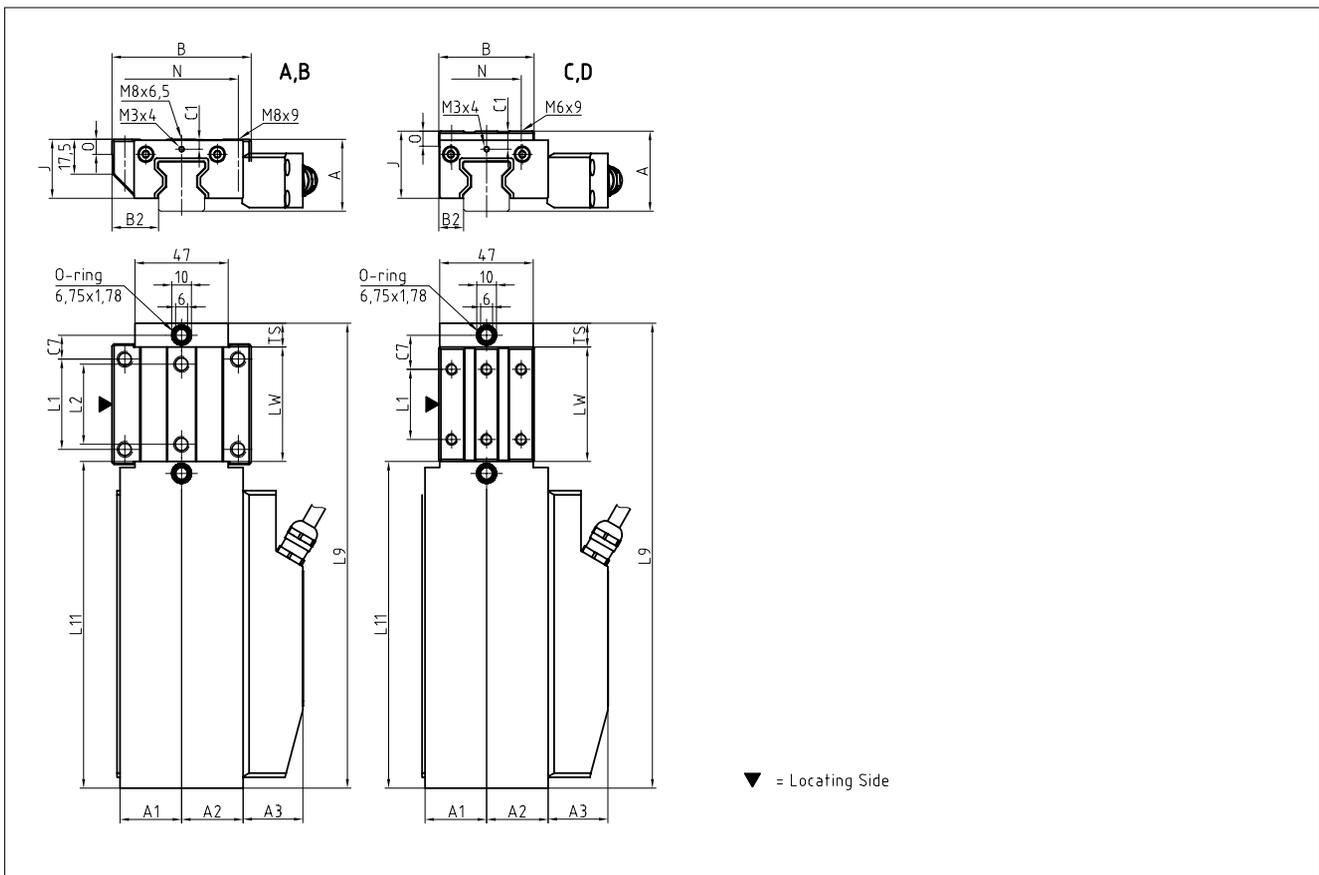

AMSA 3L W 25 Rigidity diagram

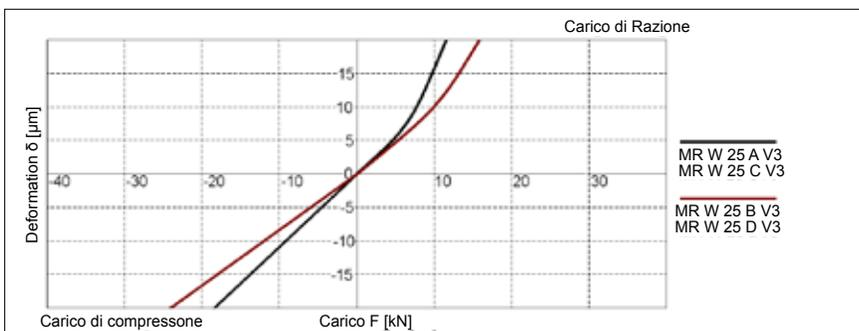

AMSA 3L W 25 Load rating

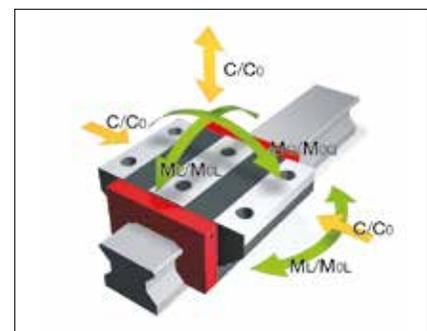

11.2 Technical data and options

AMSA 3L Size 25

AMSA 3L S 25 Dimensions



	AMSA 3L S 25-N				
B1: Rail width	23				
J1: Rail height	24.45				
L3: Rail length	2 999.5				
L3': System length	3 000				
S: Gap size	0.5				
L4: Spacing of fixing holes	30				
L5/L10: Position of first/last fixing hole	14.75				
Gew.: Rail weight, specific (kg/m)	3.4				

Available options for AMSA 3L S 25



AMSA 3L W 25 Dimensions and capacities

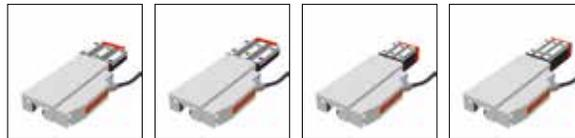

	AMSA 3L W 25-A	AMSA 3L W 25-B	AMSA 3L W 25-C	AMSA 3L W 25-D		
A: System height	36	36	40	40		
A1: Half width of housing on opposite side	31	31	31	31		
A2: Half width of housing on reading head side	31	31	31	31		
A3: Projection of reading head	30	30	30	30		
B: Carriage width	70	70	48	48		
B2: Distance between locating faces	23.5	23.5	12.5	12.5		
C1: Position of center front lube hole*	5 / 5.5	5 / 5.5	9 / 9.5	9 / 9.5		
C3: Position of lateral lube hole	-	-	-	-		
C4: Position of lateral lube hole	-	-	-	-		
C7: Position of top lube hole	12	23.2	17	20.7		
J: Carriage height	29.5	29.5	33.5	33.5		
L1: Exterior fixing hole spacing	45	45	35	50		
L2: Interior fixing hole spacing	40	40	-	-		
L9: Carriage length with housing	232.2	254.6	232.2	254.6		
L11: Housing length	163.2	163.2	163.2	163.2		
Lw: Inner carriage body length	57	79.4	57	79.4		
N: Lateral fixing hole spacing	57	57	35	35		
O: Reference face height	7.5	7.5	7.5	7.5		
Ts: Front plate thickness	12	12	12	12		
Capacities and weights						
C0: Static load capacity (N)	49800	70300	49800	70300		
C100: Dynamic load capacity (N)	27700	39100	27700	39100		
MOQ: Static cross moment capacity (Nm)	733	1035	733	1035		
MOL: Static longitud. moment capacity (Nm)	476	936	476	936		
MQ: Dyn. cross moment capacity (Nm)	408	576	408	576		
ML: Dyn. longitud. moment capacity (Nm)	265	521	265	521		
Gew: Carriage weight (kg)	1.4	1.6	1.3	1.4		

Note: * Values valid for external housing / front plate

Available options for AMSA 3L W 25



AMSA 3L S 35 Drawings

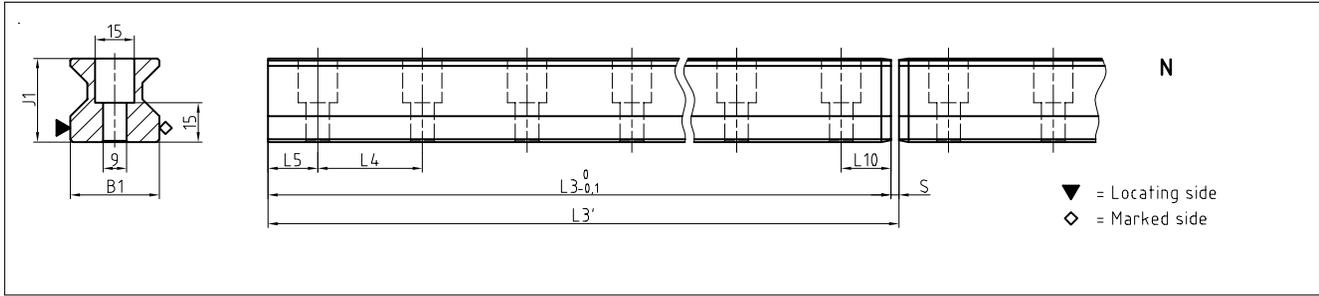

AMSA 3L W 35 Drawings

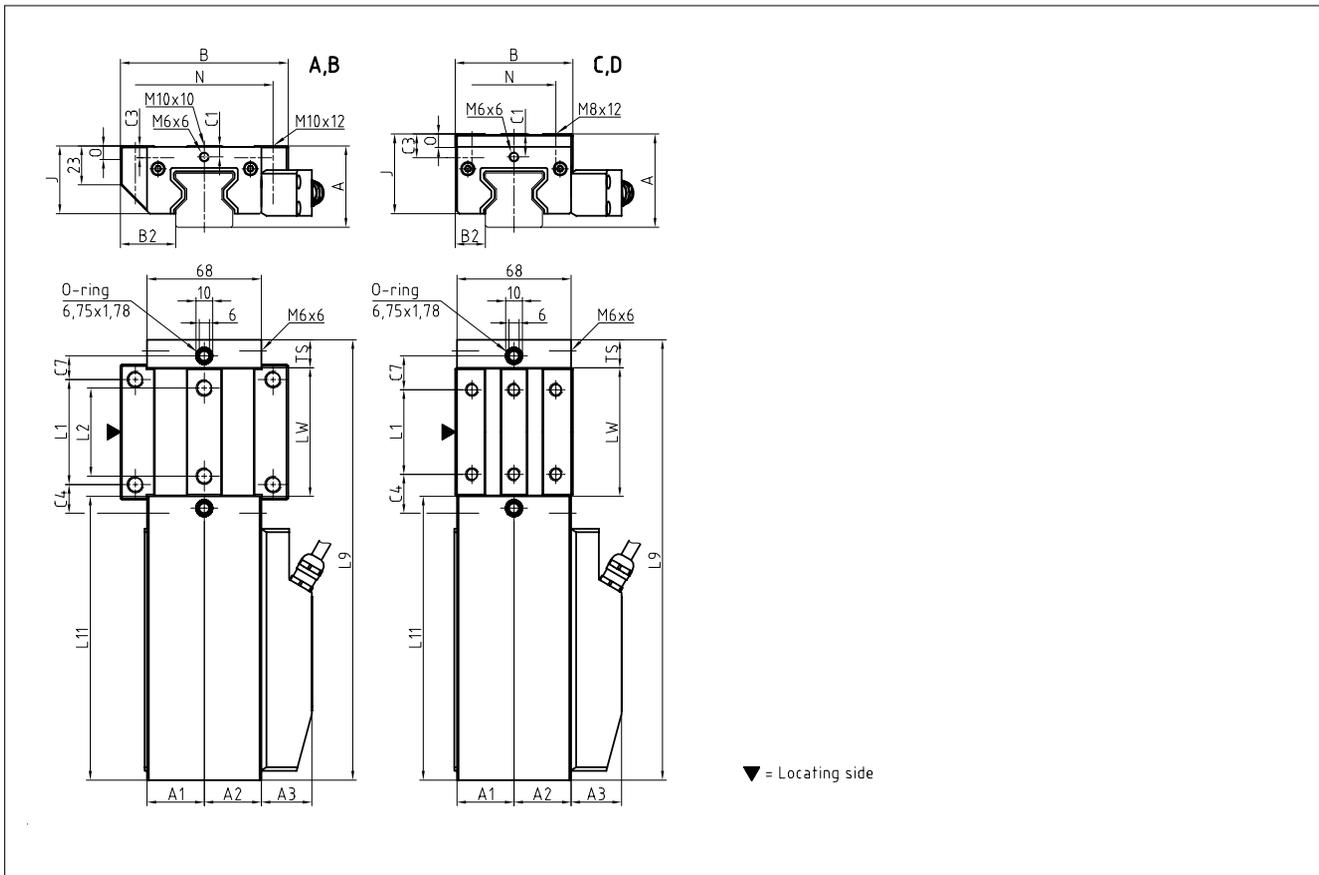

AMSA 3L W 35 Rigidity diagram

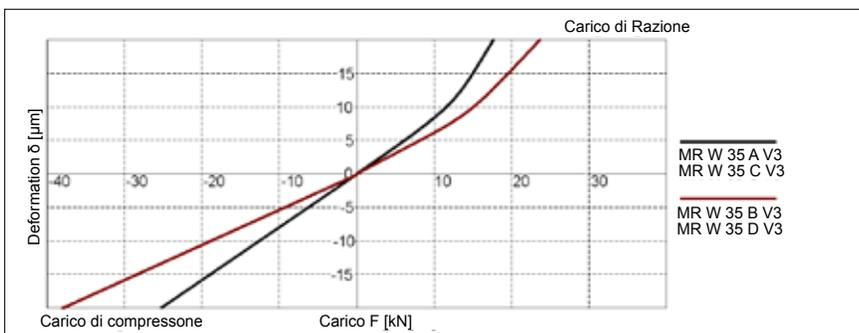

AMSA 3L W 35 Load rating

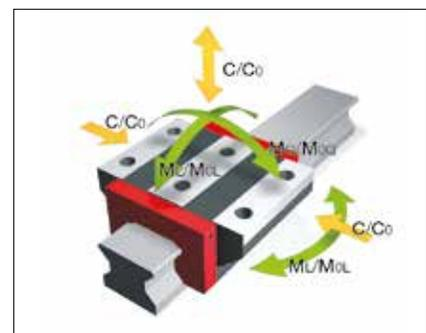

11.2 Technical data and options

AMSA 3L Size 35

AMSA 3L S 35 Dimensions



	AMSA 3L S 35-N				
B1: Rail width	34				
J1: Rail height	31.95				
L3: Rail length	2 999.5				
L3': System length	3 000				
S: Gap size	0.5				
L4: Spacing of fixing holes	40				
L5/L10: Position of first/last fixing hole	19.75				
Gew.: Rail weight, specific (kg/m)	6.5				

Available options for AMSA 3L S 35

AMSA 3L W 35 Dimensions and capacities

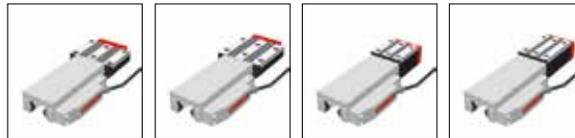

	AMSA 3L W 35-A	AMSA 3L W 35-B	AMSA 3L W 35-C	AMSA 3L W 35-D		
A: System height	48	48	55	55		
A1: Half width of housing on opposite side	34	34	34	34		
A2: Half width of housing on reading head side	34	34	34	34		
A3: Projection of reading head	30	30	30	30		
B: Carriage width	100	100	70	70		
B2: Distance between locating faces	33	33	18	18		
C1: Position of center front lube hole*	6.5 / 7	6.5 / 7	13.5 / 14	13.5 / 14		
C3: Position of lateral lube hole	7	7	14	14		
C4: Position of lateral lube hole	17	30.5	23	25.5		
C7: Position of top lube hole	14	27.5	20	22.5		
J: Carriage height	40	40	47	47		
L1: Exterior fixing hole spacing	62	62	50	72		
L2: Interior fixing hole spacing	52	52	-	-		
L9: Carriage length with housing	260.2	287.2	260.2	287.2		
L11: Housing length	167.7	167.7	167.7	167.7		
Lw: Inner carriage body length	76	103	76	103		
N: Lateral fixing hole spacing	82	82	50	50		
O: Reference face height	8	8	8	8		
Ts: Front plate thickness	16.5	16.5	16.5	16.5		
Capacities and weights						
C0: Static load capacity (N)	93400	128500	93400	128500		
C100: Dynamic load capacity (N)	52000	71500	52000	71500		
MOQ: Static cross moment capacity (Nm)	2008	2762	2008	2762		
MOL: Static longitud. moment capacity (Nm)	1189	2214	1189	2214		
MQ: Dyn. cross moment capacity (Nm)	1118	1537	1118	1537		
ML: Dyn. longitud. moment capacity (Nm)	662	1232	662	1232		
Gew: Carriage weight (kg)	2.5	3.1	2.4	2.9		

Note: * Values valid for external housing / front plate

Available options for AMSA 3L W 35



AMSA 3L S 45 Drawings

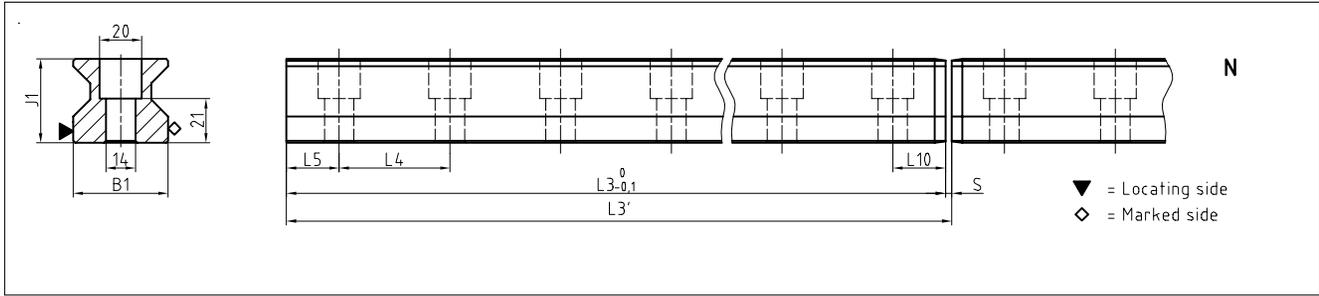

AMSA 3L W 45 Drawings

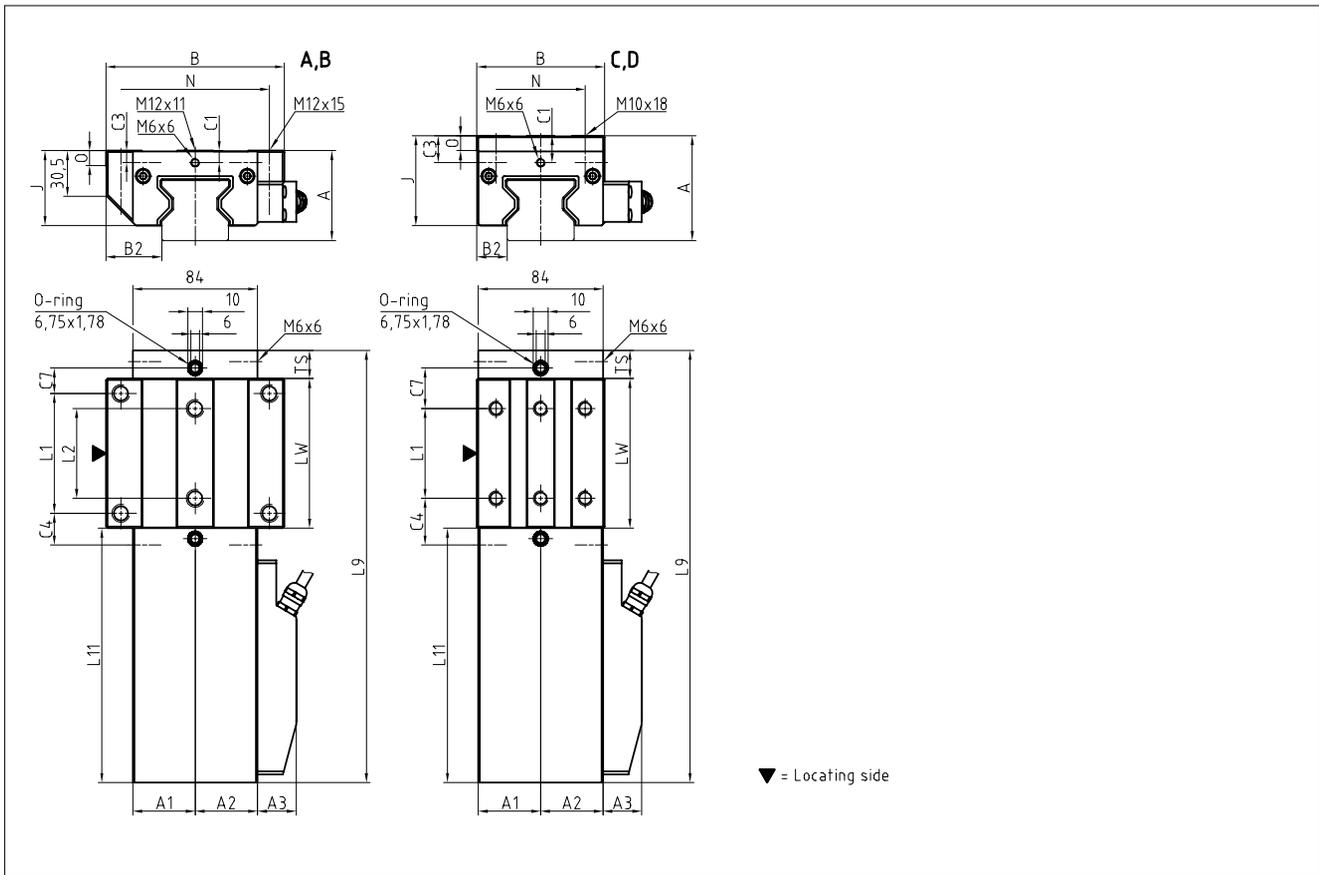

AMSA 3L W 45 Rigidity diagram

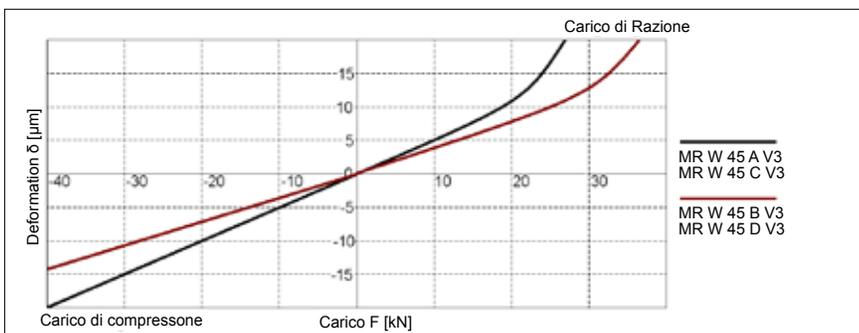

AMSA 3L W 45 Load rating

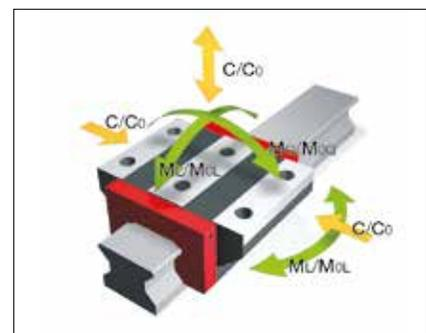

11.2 Technical data and options

AMSA 3L Size 45

AMSA 3L S 45 Dimensions



	AMSA 3L S 45-N				
B1: Rail width	45				
J1: Rail height	39.95				
L3: Rail length	2992				
L3': System length	2992.5				
S: Gap size	0.5				
L4: Spacing of fixing holes	52.5				
L5/L10: Position of first/last fixing hole	26				
Gew.: Rail weight, specific (kg/m)	10.8				

Available options for AMSA 3L S 45



AMSA 3L W 45 Dimensions and capacities



	AMSA 3L W 45-A	AMSA 3L W 45-B	AMSA 3L W 45-C	AMSA 3L W 45-D		
A: System height	60	60	70	70		
A1: Half width of housing on opposite side	42	42	42	42		
A2: Half width of housing on reading head side	42	42	42	42		
A3: Projection of reading head	26	26	26	26		
B: Carriage width	120	120	86	86		
B2: Distance between locating faces	37.5	37.5	20.5	20.5		
C1: Position of center front lube hole	8	8	18	18		
C3: Position of lateral lube hole	8	8	18	18		
C4: Position of lateral lube hole	21.5	38.75	31.25	38.75		
C7: Position of top lube hole	17	34.5	27	34.5		
J: Carriage height	50	50	60	60		
L1: Exterior fixing hole spacing	80	80	60	80		
L2: Interior fixing hole spacing	60	60	-	-		
L9: Carriage length with housing	288.7	323.7	288.7	323.7		
L11: Housing length	169.9	169.9	169.9	169.9		
Lw: Inner carriage body length	100	135	100	135		
N: Lateral fixing hole spacing	100	100	60	60		
O: Reference face height	10	10	10	10		
Ts: Front plate thickness	18.8	18.8	18.8	18.8		
Capacities and weights						
C0: Static load capacity (N)	167500	229500	167500	229500		
C100: Dynamic load capacity (N)	93400	127800	93400	127800		
MOQ: Static cross moment capacity (Nm)	4621	6333	4621	6333		
MOL: Static longitud. moment capacity (Nm)	2790	5161	2790	5161		
MQ: Dyn. cross moment capacity (Nm)	2577	3527	2577	3527		
ML: Dyn. longitud. moment capacity (Nm)	1556	2874	1556	2874		
Gew: Carriage weight (kg)	4.4	5.5	4.2	5.2		

Available options for AMSA 3L W 45



AMSA 3L S 55 Drawings

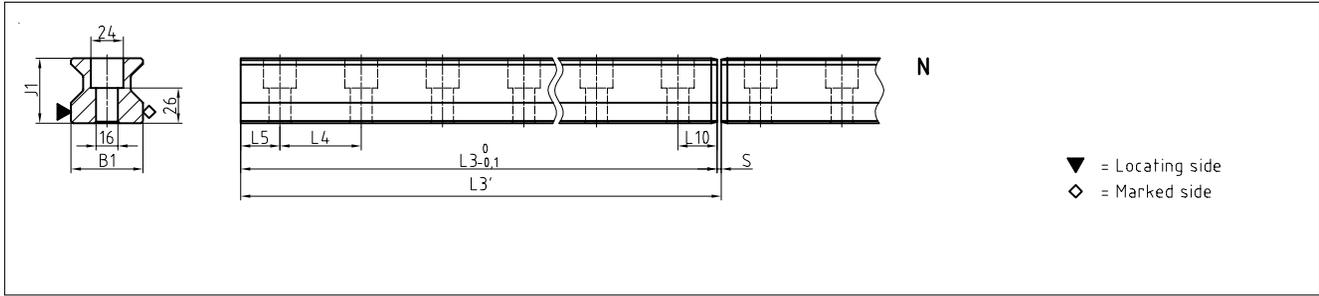

AMSA 3L W 55 Drawings

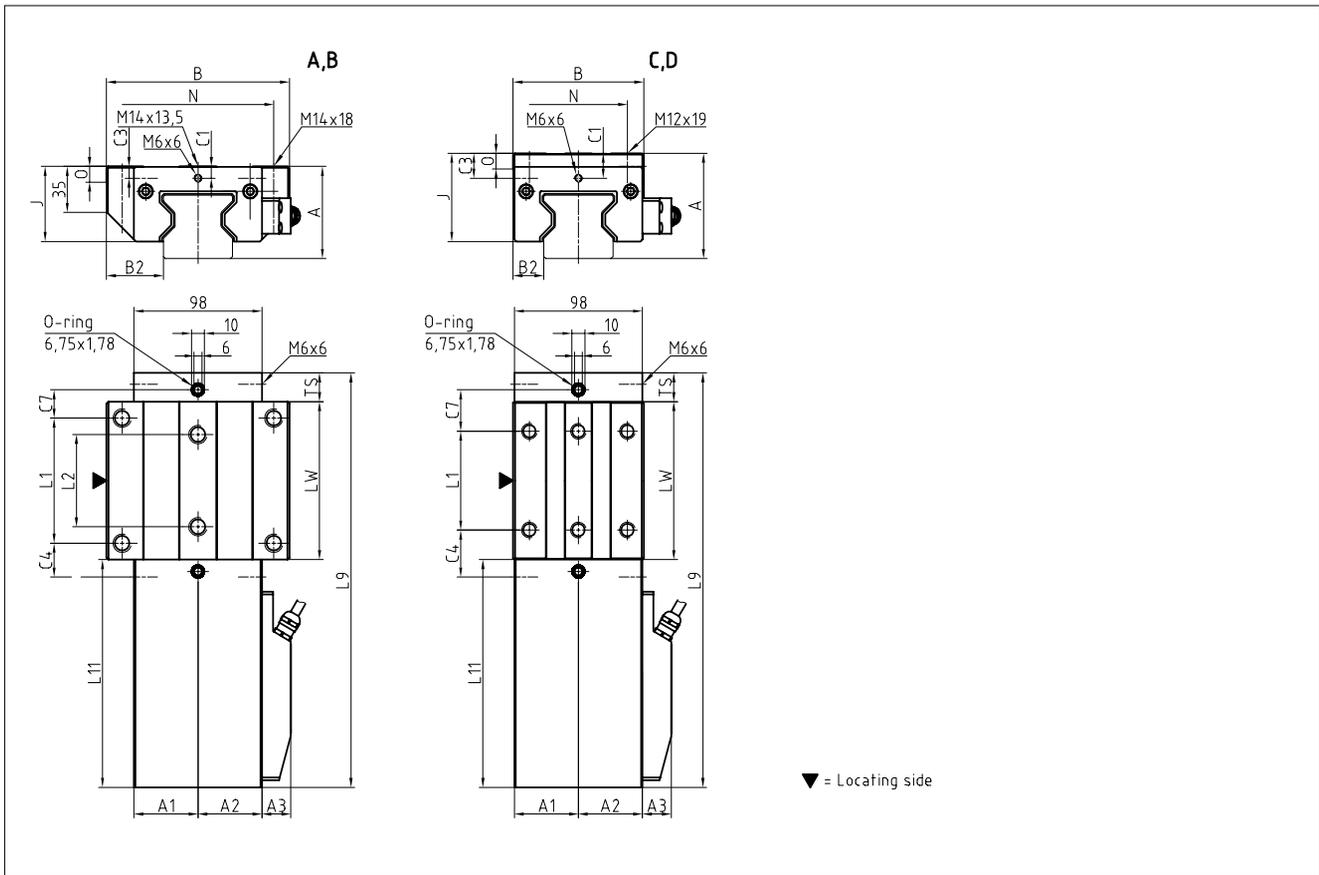

AMSA 3L W 55 Rigidity diagram

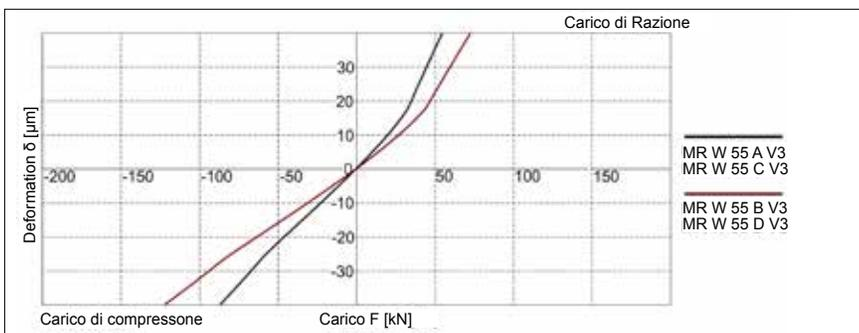

AMSA 3L W 55 Load rating

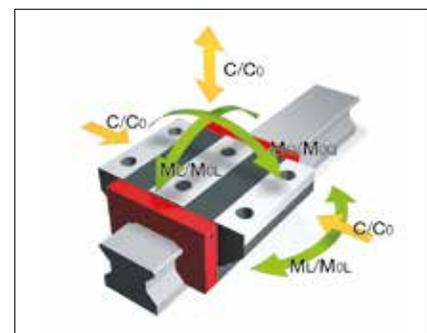

11.2 Technical data and options

AMSA 3L Size 55

AMSA 3L S 55 Dimensions



	AMSA 3L S 55-N				
B1: Rail width	53				
J1: Rail height	47.95				
L3: Rail length	2999.5				
L3': System length	3 000				
S: Gap size	0.5				
L4: Spacing of fixing holes	60				
L5/L10: Position of first/last fixing hole	29.75				
Gew.: Rail weight, specific (kg/m)	15.2				

Available options for AMSA 3L S 55



AMSA 3L W 55 Dimensions and capacities

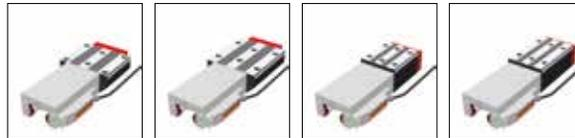

	AMSA 3L W 55-A	AMSA 3L W 55-B	AMSA 3L W 55-C	AMSA 3L W 55-D		
A: System height	70	70	80	80		
A1: Half width of housing on opposite side	49	49	49	49		
A2: Half width of housing on reading head side	49	49	49	49		
A3: Projection of reading head	22	22	22	22		
B: Carriage width	140	140	100	100		
B2: Distance between locating faces	43.5	43.5	23.5	23.5		
C1: Position of center front lube hole	9	9	19	19		
C3: Position of lateral lube hole	9	9	19	19		
C4: Position of lateral lube hole	25.75	46.75	35.75	46.75		
C7: Position of top lube hole	21.5	42.5	31.5	42.5		
J: Carriage height	57	57	67	67		
L1: Exterior fixing hole spacing	95	95	75	95		
L2: Interior fixing hole spacing	70	70	-	-		
L9: Carriage length with housing	314.7	356.7	314.7	356.7		
L11: Housing length	172.9	172.9	172.9	172.9		
Lw: Inner carriage body length	120	162	120	162		
N: Lateral fixing hole spacing	116	116	75	75		
O: Reference face height	12	12	12	12		
Ts: Front plate thickness	21.8	21.8	21.8	21.8		
Capacities and weights						
C0: Static load capacity (N)	237000	324000	237000	324000		
C100: Dynamic load capacity (N)	131900	180500	131900	180500		
MOQ: Static cross moment capacity (Nm)	7771	10624	7771	10624		
MOL: Static longitud. moment capacity (Nm)	4738	8745	4738	8745		
MQ: Dyn. cross moment capacity (Nm)	4325	5919	4325	5919		
ML: Dyn. longitud. moment capacity (Nm)	2637	4872	2637	4872		
Gew: Carriage weight (kg)	6.4	8.2	5.9	7.5		

Available options for AMSA 3L W 55



AMSA 3L S 65 Drawings

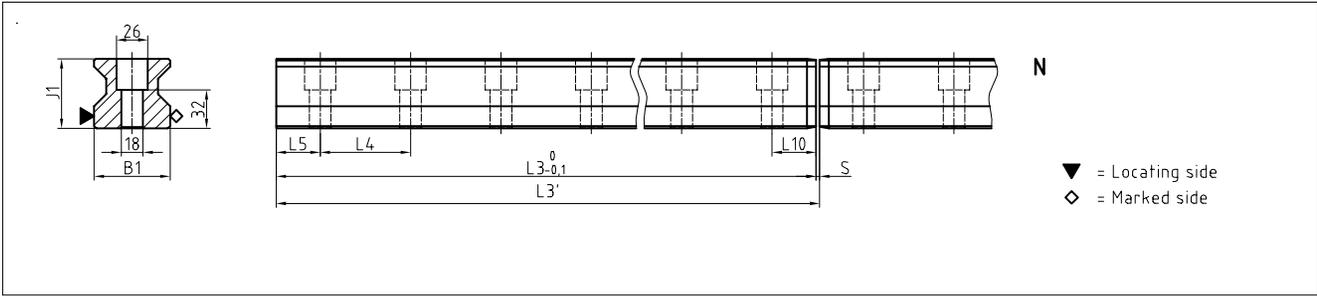

AMSA 3L W 65 Drawings

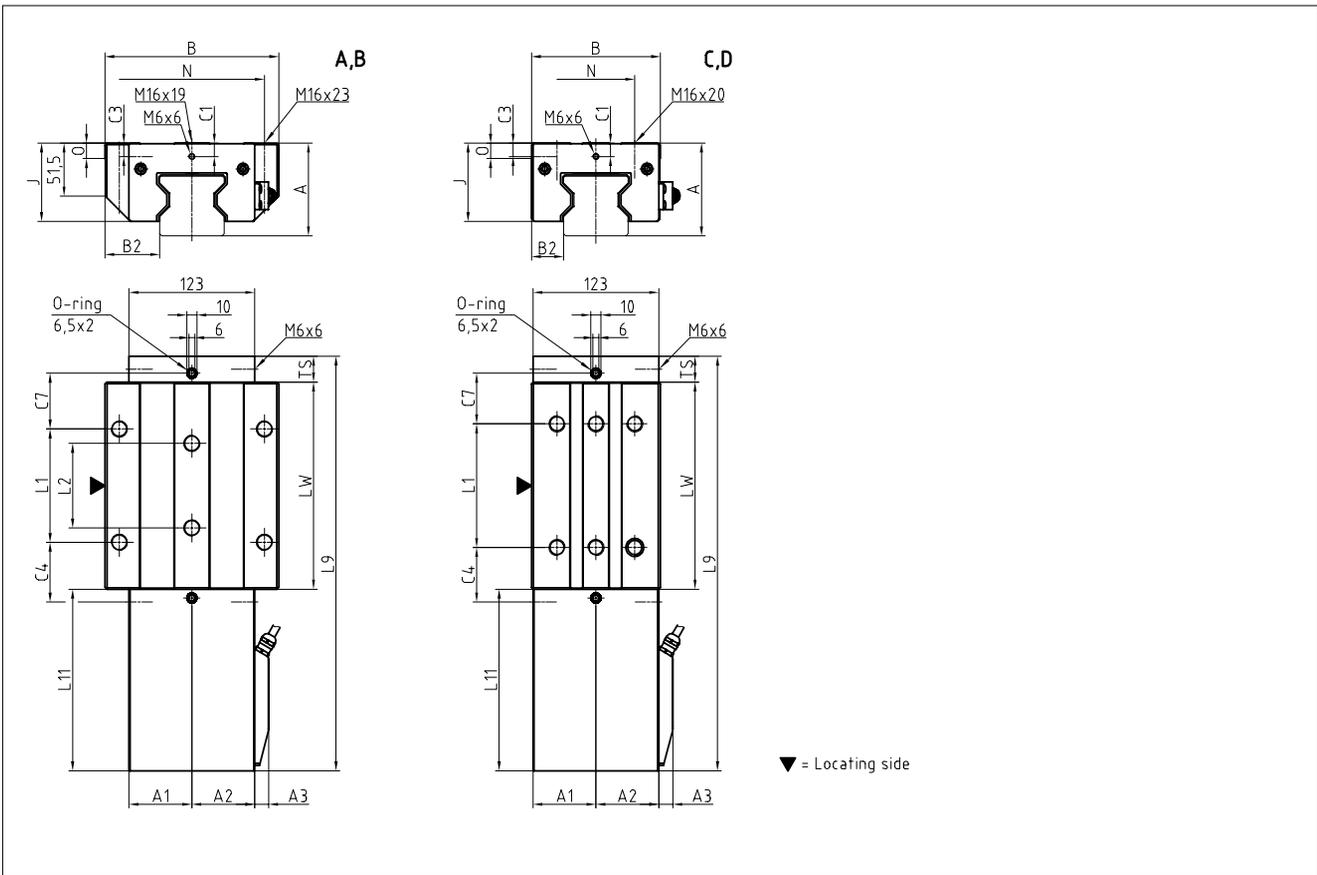

AMSA 3L W 65 Rigidity diagram

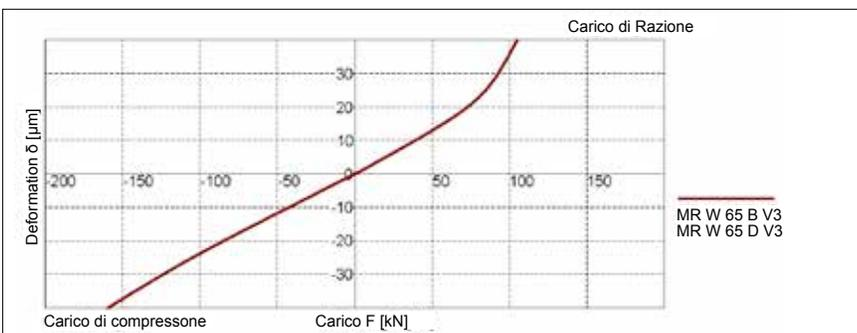

AMSA 3L W 65 Load rating

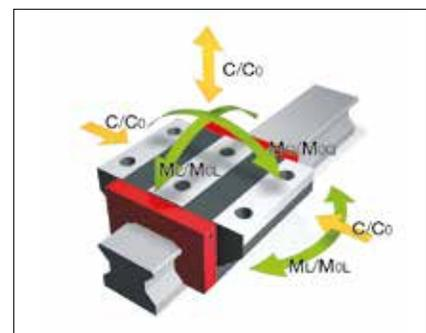

11.2 Technical data and options

AMSA 3L Size 65

AMSA 3L S 65 Dimensions



	AMSA 3L S 65-N				
B1: Rail width	63				
J1: Rail height	57.95				
L3: Rail length	2999.5				
L3': System length	3 000				
S: Gap size	0.5				
L4: Spacing of fixing holes	75				
L5/L10: Position of first/last fixing hole	37.25				
Gew.: Rail weight, specific (kg/m)	22.8				

Available options for AMSA 3L S 65



AMSA 3L W 65 Dimensions and capacities



	AMSA 3L W 65-A	AMSA 3L W 65-B	AMSA 3L W 65-C	AMSA 3L W 65-D		
A: System height	90	90	90	90		
A1: Half width of housing on opposite side	61.5	61.5	61.5	61.5		
A2: Half width of housing on reading head side	61.5	61.5	61.5	61.5		
A3: Projection of reading head	13.5	13.5	13.5	13.5		
B: Carriage width	170	170	126	126		
B2: Distance between locating faces	53.5	53.5	31.5	31.5		
C1: Position of center front lube hole	13	13	13	13		
C3: Position of lateral lube hole	13	13	13	13		
C4: Position of lateral lube hole	31.75	58	51.75	53		
C7: Position of top lube hole	27.75	54	47.75	49		
J: Carriage height	76	76	76	76		
L1: Exterior fixing hole spacing	110	110	70	120		
L2: Interior fixing hole spacing	82	82	-	-		
L9: Carriage length with housing	349.7	402.2	349.7	402.2		
L11: Housing length	176.2	176.2	176.2	176.2		
Lw: Inner carriage body length	148.5	201	148.5	201		
N: Lateral fixing hole spacing	142	142	76	76		
O: Reference face height	15	15	15	15		
Ts: Front plate thickness	25	25	25	25		
Capacities and weights						
C0: Static load capacity (N)	419000	530000	419000	530000		
C100: Dynamic load capacity (N)	232000	295000	232000	295000		
MOQ: Static cross moment capacity (Nm)	16 446	20912	16446	20912		
MOL: Static longitud. moment capacity (Nm)	10754	17930	10754	17930		
MQ: Dyn. cross moment capacity (Nm)	9154	11640	9154	11640		
ML: Dyn. longitud. moment capacity (Nm)	5954	9980	5954	9980		
Gew: Carriage weight (kg)	12.6	15.9	10.3	12.8		

Available options for AMSA 3L W 65



AMSA 3L Rails accessories overview

Accessories	AMSA 3L S 25	AMSA 3L S 35	AMSA 3L S 45	AMSA 3L S 55	AMSA 3L S 65		
Plugs:							
Plastic plugs	MRK 25	MRK 35	MRK 45	MRK 55	MRK 65		
Brass plugs	MRS 25	MRS 35	MRS 45	MRS 55	MRS 65		
Steel plugs	MRZ 25	MRZ 35	MRZ 45	MRZ 55	MRZ 65		
Assembly tools:							
Assembly tool for AMSA 3L	MWM 3L 25	MWM 3L 35	MWM 3L 45	MWM 3L 55	MWM 3L 65		
Installation tool for steel plugs	MWH 25	MWH 35	MWH 45	MWH 55	MWH 65		
Hydraulic cylinder for MWH	MZH	MZH	MZH	MZH	MZH		
End pieces:							
End piece for AMSA 3L rails	EST 3L 25	EST 3L 35	EST 3L 45	EST 3L 55	EST 3L 65		

AMSA 3L Carriages accessories overview

Accessories	AMSA 3L W 25	AMSA 3L W 35	AMSA 3L W 45	AMSA 3L W 55	AMSA 3L W 65		
Additional wipers:							
Additional wipers NBR	ZCN 25	ZCN 35	ZCN 45	ZCN 55	ZCN 65		
Additional wipers Viton	ZCV 25	ZCV 35	ZCV 45	ZCV 55	ZCV 65		
Metal wiper	ASM 25-A	ASM 35-A	ASM 35-A	ASM 55-A	ASM 65-A		
Bellows:							
Bellows	FBM 25	FBM 35	FBM 45	FBM 55	FBM 65		
Adapter plate for bellows (spare part)	ZPL 25	ZPL 35	ZPL 45	ZPL 55	ZPL 65		
End plate for bellows (spare part)	EPL 25	EPL 35	EPL 45	EPL 55	EPL 65		
Assembly rails:							
Assembly rail	MRM 3L 25	MRM 3L 35	MRM 3L 45	MRM 3L 55	MRM 3L 65		
Lubrication plates:							
Lubrication plate	SPL 25-MR	SPL 35-MR	SPL 45-MR	SPL 55-MR	SPL 65-MR		
Front plates:							
Front plate (spare part)	STP 25-EK	STP 35-EK	STP 45-EK	STP 55-EK	STP 65-EK		
Lube nipples:							
Hydraulic-type grease nipple straight	SN 6	SN 6	SN 6	SN 6	SN 6		
Hydraulic-type grease nipple 45°	SN 6-45	SN 6-45	SN 6-45	SN 6-45	SN 6-45		
Hydraulic-type grease nipple 90°	SN 6-90	SN 6-90	SN 6-90	SN 6-90	SN 6-90		
Flush type grease nipple M3	SN 3-T	-	-	-	-		
Flush type grease nipple M6	SN 6-T	SN 6-T	SN 6-T	SN 6-T	SN 6-T		
Grease gun for SN 3-T und SN 6-T	SFP-T3	SFP-T3	SFP-T3	SFP-T3	SFP-T3		
Lube adapters:							
Straight screw-in connection M3	SA 3-D3	-	-	-	-		
Lubrication adapter M8 round-head	SA 6-RD-M8	SA 6-RD-M8	SA 6-RD-M8	SA 6-RD-M8	SA 6-RD-M8		
Lubrication adapter M8 hexagon head	-	SA 6-6KT-M8	SA 6-6KT-M8	SA 6-6KT-M8	SA 6-6KT-M8		
Lubrication adapter G1/8 hexagon head	-	SA 6-6KT-G1/8	SA 6-6KT-G1/8	SA 6-6KT-G1/8	SA 6-6KT-G1/8		
Swivel screw connection for pipe d=4 mm	SV 6-D4	SV 6-D4	SV 6-D4	SV 6-D4	SV 6-D4		
Swivel screw connection M6	SV 6-M6	SV 6-M6	SV 6-M6	SV 6-M6	SV 6-M6		
Swivel screw connection M6 long	SV 6-M6-L	SV 6-M6-L	SV 6-M6-L	SV 6-M6-L	SV 6-M6-L		
Swivel screw connection M8	SV 6-M8	SV 6-M8	SV 6-M8	SV 6-M8	SV 6-M8		
Swivel screw connection M8 long	SV 6-M8-L	SV 6-M8-L	SV 6-M8-L	SV 6-M8-L	SV 6-M8-L		

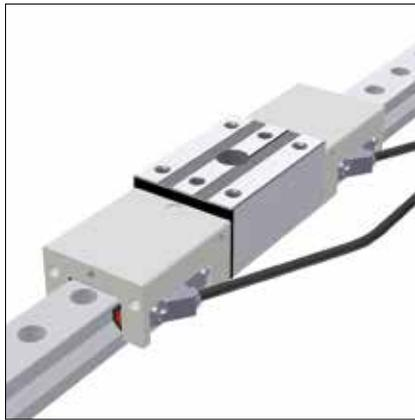

Assembly tools

The MWM3L assembly tool is intended for the phase-locked assembly of the AMSA 3L rails. It consists of a size-dependent guide carriage, two mounting housings and two reading heads for registering the phase. Furthermore, the MWM assembly tool contains the display software for calibrating measurements and the assembly and start-up instructions.

Order code: **MWM 3L xx**

xx = size, ordering example: 1 x MWM 3L 55

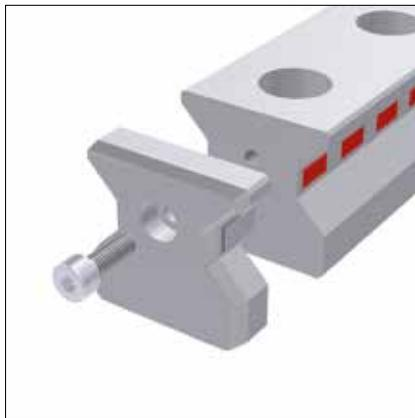

End pieces

The AMSA 3L concept allows the rails to be separated according to the desires of the customer for the first and last rail segments of a set of rails.

After separation, the EST 3L end pieces prevent the masking tape on the measuring element from detaching. The end pieces may be used on both sides, and are attached using a central screw in the front drill holes.

Order code: **EST 3L xx**

xx = size, ordering example: 1 x EST 3L 55

11.4 Order key

Individual guide rails and carriages are ordered in accordance with the order codes described below.

AMSA 3L carriages consist of guide carriage, casing and reading head.

All MONORAIL MR carriages can also be used with AMSA 3L rails.

Q.v. chapter 2 and chapter 3.3 for the order key for accessories.

Separate order codes are used in each case for rails, carriages and accessories. This also applies to different versions of rails and carriages.

All guide components are supplied individually as standard, i.e. unassembled.

If required, SCHNEEBERGER can also supply rails and carriages assembled incl. accessories as complete systems. Please note the ordering instructions in chapter 2.4 if this applies.

Order code for AMSA 3L Rails

	1x	AMSA 3L S	35	-N	-G1	-KC	-R11	-3000	-CN	-TA1
Quantity										
Rail										
Size										
Type										
Accuracy										
Straightness										
Reference side										
Rail length L3										
Coating										
Type of magnetisation										

NB

Q.v. chapter 11.1 to 11.3 for an overview of types, details of shapes, available options and accessories.

Q.v. chapter 2 for a description of the options.

If possible, standard lengths are preferred for L3 rail length.

These are calculated with the table values in chapter 11.2 using the following formula: $L3 = n \times L4 + L5 + L10 \leq L3_{max}$.

Order code for AMSA 3L Carriages

	1x	AMSA 3L W	35	-B	-P1	-G1	-V3	-R2	-CN	-S12	-LN	-TSU
Quantity												
Carriage												
Size												
Type												
Reading head position												
Accuracy												
Preload												
Reference side												
Coating												
Lube connection												
Lubrication as delivered condition												
Interface												

NB

Q.v. chapter 11.1 to 11.3 for an overview of types, details of shapes, available options and accessories.

Q.v. chapter 2 for a description of the options.

For detailed information about current configuration options for the interfaces, please visit our website at www.schneeberger.com

PROSPECTUSES

- AUTOMATION
- COMPANY BROCHURE
- CUSTOMIZED BEARINGS
- GEAR RACKS
- LINEAR BEARINGS AND RECIRCULATING UNITS
- MINERAL CASTING SCHNEEBERGER
- MINIRAIL the miniature guideway
- MINISCALE miniature guideway with integrated measuring system
- MINISLIDE micro frictionless tables
- MONORAIL AND AMS profiled linear guideways with integrated measuring system
- MONORAIL AND AMS application catalog
- POSITIONING SYSTEMS
- SLIDES



SCHNEEBERGER COMPANIES

SWITZERLAND

SCHNEEBERGER AG
St. Urbanstrasse 12
4914 Roggwil/BE

Phone +41 62 918 41 11
Fax +41 62 918 41 00

E-Mail:
info-ch@schneeburger.com

JAPAN

Nippon SCHNEEBERGER K.K.
Shimouma Miyagawa Bld 4F
1-49-12 Shimouma, Setagaya-ku
154-0002 Tokyo

Phone +81 3 5779 7339
Fax +81 3 3487 6010

E-Mail:
info-j@schneeburger.com

JAPAN

日本シュネーベルガー株式会社
〒154-0002
東京都世田谷区下馬1-49-12
下馬MIYAGAWAビル
1階(ショースペース) 斎(営業部)

電話 03 5779 7339
ファックス 03 3487 6010

E-Mail:
info-j@schneeburger.com

GERMANY

SCHNEEBERGER GmbH
Gräfenau
75339 Höfen/Enz

Phone +49 7081 782 0
Fax +49 7081 782 124

E-Mail:
info-d@schneeburger.com

CHINA

SCHNEEBERGER (Shanghai) Co., Ltd.
Rm 606, Shang Gao International
Building
No. 137 XianXia Road
200051 Shanghai

Phone +86 21 6209 0037 / 27
Fax +86 21 6209 0102

E-Mail:
info-cn@schneeburger.com

CHINA

施耐博格(上海)传动技术有限公司
上海市长宁区
仙霞路137号盛高国际大厦606室, 上海 200051

电话 +86 21 6209 0027
传真 +86 21 6209 0102

邮箱:
info-cn@schneeburger.com

ITALY

SCHNEEBERGER S.r.l.
Via Soldani 10
21021 Angera (VA)

Phone +39 0331 93 2010
Fax +39 0331 93 1655

E-Mail:
info-i@schneeburger.com

KOREA

SCHNEEBERGER Korea LTD
POSCO Center Bldg
West Tower 11th FL
802 Daech 4-Dong
Kangnam-gu
135-777 Seoul

Phone +82 2 559 073 5
Fax +82 2 442 297 1

E-Mail:
info-kr@schneeburger.com

KOREA

슈네베르코리아 유한회사
서울특별시 강남구 대치4동
802 포스코센터빌딩 서관 11층
1134호

전화 +82 2 559 073 5
팩스 +82 2 442 297 1

이메일:
info-kr@schneeburger.com

USA

SCHNEEBERGER Inc.
11 DeAngelo Drive
Bedford, MA 01730

Phone +1 781 271 0140
Fax +1 781 275 4749

E-Mail:
info-usa@schneeburger.com

SINGAPORE

SCHNEEBERGER LINEAR
TECHNOLOGY PTE. Ltd.
160 Paya Lebar Road, #05-04
Orion Industrial Building
409022 Singapore

Phone + 65 6841 2385
Fax + 65 6841 3408

E-Mail:
info-sg@schneeburger.com

INDIA

SCHNEEBERGER India Pvt. Ltd.
404, 4th Floor, Satra Plaza,
Palm Beach Road, Sector 19D Vashi,
400 703 New Mumbai

Phone +91 22 6461 0646
+91 22 6461 1756

E-Mail:
info-in@schneeburger.com

SCHNEEBERGER MINERAL CASTING

CZECH REPUBLIC

SCHNEEBERGER
Mineralgusstechnik s.r.o.
Prumyslový park 32/20
350 02 Cheb – Dolní Dvory

Phone +420 354 400 941
Fax +420 354 400 940

E-Mail:
info-mineralguss@schneeburger.com

CHINA

SCHNEEBERGER Changzhou
Precision Systems Co. Ltd.
137 Hanjiang Road
Changzhou New district
213000 Changzhou, Jiangsu

Phone +86 519 8988 3938
Fax +86 519 8988 5115

E-Mail:
info-mineralcasting@schneeburger.com

CHINA

施耐博格(常州)测试系统有限公司
汉江路137, 常州新区, 常州213022

电话 +86 519 8988 3938
传真 +86 519 8988 5115

邮箱:
info-mineralcasting@schneeburger.com

SCHNEEBERGER SALES DEPARTMENTS

AUSTRIA

Mobile +43 676 935 1035

E-Mail:
info-a@schneeburger.com

ISRAEL

Mobile +972 5 0551 7920

E-Mail:
info-i@schneeburger.com

BENELUX

Mobile +31 6 5326 3929

E-Mail:
info-nl@schneeburger.com

POLAND, SLOVAKIA, CZECH REPUBLIC

Mobile +420 6 0278 4077

E-Mail:
info-cz@schneeburger.com

DENMARK, SWEDEN

Mobile +31 6 5326 3929

E-Mail:
info-nl@schneeburger.com

RUSSIA, BELARUS, UKRAINE

Mobile +7 985 960 85 53
Mobile +38 050 407 6789
Mobile +37 529 860 0410

E-Mail:
info-ru@schneeburger.com

FRANCE

Mobile +33 6 0941 6269

E-Mail:
info-f@schneeburger.com

SPAIN, PORTUGAL

Mobile +34 629 918 302

E-Mail:
info-es@schneeburger.com

GREAT BRITAIN

Mobile +44 77 8814 5645

E-Mail:
info-uk@schneeburger.com

