

OFU/DFU (DIN 69051 FORM B) Series Specifications

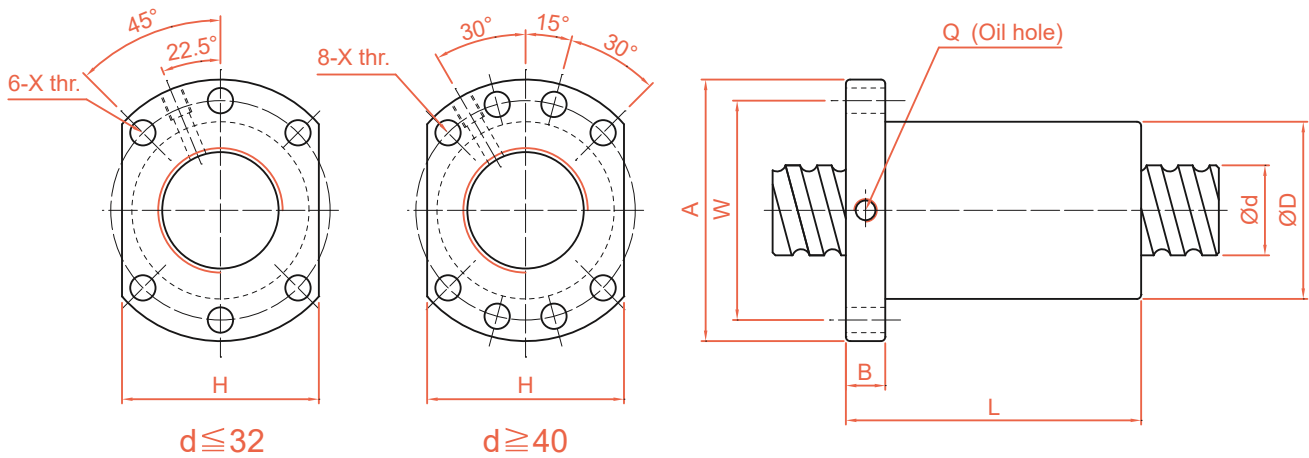

Unit : mm

Model No.	d	I	Da	Dimension									Load Rating		K kgf/μm
				D	A	B	L	W	H	X	Q	n	Ca (kgf)	Coa (kgf)	
OFU01605-8	16	5	3.175	28	48	10	75	38	40	5.5	M6	1x8	1380	3052	44
OFU02005-8	20	5	3.175	36	58	10	85	47	44	6.6	M6	1x8	1551	3875	53
OFU02505-8	25	5	3.175	40	62	10	86	51	48	6.6	M6	1x8	1724	4904	62
OFU02510-8		10	4.762	40	62	12	130	51	48	6.6	M6	1x8	2954	7295	67
OFU03205-8	32	5	3.175	50	80	12	87	65	62	9	M6	1x8	1922	6343	74
OFU03210-8		10	6.35	50	80	12	145	65	62	9	M6	1x8	4805	12208	82
OFU04005-8	40	5	3.175	63	93	14	90	78	70	9	M8	1x8	2110	7988	87
OFU04010-8		10	6.35	63	93	14	148	78	70	9	M8	1x8	5399	15500	99
OFU05010-8	50	10	6.35	75	110	16	148	93	85	11	M8	1x8	6004	19614	117
OFU06310-8	63	10	6.35	90	125	18	153	108	95	11	M8	1x8	6719	25358	139
OFU08010-8	80	10	6.35	105	145	20	153	125	110	13.5	M8	1x8	7346	31953	156
DFU01604-4	16	4	2.381	28	48	10	80	38	40	5.5	M6	1x4	973	2406	43
DFU02004-4	20	4	2.381	36	58	10	80	47	44	6.6	M6	1x4	1066	2987	51
DFU02504-4	25	4	2.381	40	62	10	80	51	48	6.6	M6	1x4	1180	3795	60
DFU02506-4		6	3.969	40	62	10	105	51	48	6.6	M6	1x4	2318	6057	64
DFU02508-4		8	4.762	40	62	10	120	51	48	6.6	M6	1x4	2963	7313	67
DFU03204-4	32	4	2.381	50	80	12	80	65	62	9	M6	1x4	1296	4838	71
DFU03206-4		6	3.969	50	80	12	105	65	62	9	M6	1x4	2632	7979	78
DFU03208-4		8	4.762	50	80	12	122	65	62	9	M6	1x4	3387	9622	82
DFU04006-4	40	6	3.969	63	93	14	108	78	70	9	M6	1x4	2873	9913	91
DFU04008-4		8	4.762	63	93	14	132	78	70	9	M6	1x4	3712	11947	96
DFU05020-4	50	20	7.144	75	110	16	280	93	85	11	M8	1x4	7142	22588	126
DFU06320-4	63	20	9.525	95	135	20	290	115	100	13.5	M8	1x4	11444	36653	152
DFU08020-4	80	20	9.525	125	165	25	295	145	130	13.5	M8	1x4	12911	47747	187
DFU10020-4	100	20	9.525	150	202	30	340	170	155	17.5	M8	1x4	14303	60698	222